



Owner's Manual

Original Instructions

Modbus Gateway(Mini)

model:

ME30-24/E6(M)

Thank you for choosing commercial air conditioners. Please read this Owner's Manual carefully before operation and retain it for future reference.

If you have lost the Owner's Manual, please contact the local agent or visit www.gree.com or send an email to global@gree.com.cn for the electronic version.

GREE ELECTRIC APPLIANCES, INC. OF ZHUHAI

To Users

Thank you for selecting Gree's product. Please read this instruction manual carefully before installing and using the product, so as to master and correctly use the product. In order to guide you to correctly install and use our product and achieve expected operating effect, we hereby instruct as below:

- (1) This appliance is not intended for use by persons (including children) with reduced physical, sensory or mental capabilities, or lack of experience and knowledge, unless they have been given supervision or instruction concerning use of the appliance by a person responsible for their safety. Children should be supervised to ensure that they do not play with the appliance.
- (2) In order to ensure reliability of product, the product may consume some power under stand-by status for maintaining normal communication of system and preheating refrigerant and lubricant. If the product is not to be used for long, cut off the power supply; please energize and preheat the unit in advance before reusing it.
- (3) Please properly select the model according to actual using environment, otherwise it may impact the using convenience.
- (4) This product has gone through strict inspection and operational test before leaving the factory. In order to avoid damage due to improper disassembly and inspection, which may impact the normal operation of unit, please do not disassemble the unit by yourself. You can contact with the special maintenance center of our company if necessary.
- (5) For personal injury or property loss and damage caused by improper operation such as improper installation and debugging, unnecessary maintenance, violation of related national laws and rules and industrial standard, and violation of this instruction manual, etc., we will bear no liability.





- (6) When the product is faulted and cannot be operated, please contact with our maintenance center as soon as possible by providing the following information.
- 1) Contents of nameplate of product (model, cooling/heating capacity, product No., ex-factory date).
 - 2) Malfunction status (specify the situations before and after the error occurs).
- (7) All the illustrations and information in the instruction manual are only for reference. In order to make the product better, we will continuously conduct improvement and innovation. We have the right to make necessary revision to the product from time to time due to the reason of sales or production, and reserve the right to revise the contents without further notice.
- (8) The final right to interpret for this instruction manual belongs to Gree Electric Appliances Inc. of Zhuhai.

Contents

1 Safety Notices (Please be sure to abide)	1
2 User Notice	1
3 General Functions	3
4 Composition	3
5 Detailed Introduction of Modbus Gateway(Mini)	4
5.1 Interface	4
5.1.1 Interface Function Drawing	4
5.1.2 Power	4
5.1.3 Communication Interfaces	5
5.2 LED Display	6
5.3 DIP Switches	7
5.3.1 Setting of Address DIP Switch	7
5.3.2 Address DIP Switch S1,S2—Address Setting of Modbus Gateway	8
5.3.3 The Fourth Switch of Function DIP Switch S3 - Setting of CAN2 Bus Matched Resistance	9
5.3.4 The Third Switch of Function DIP Switch S3 - Setting of Modbus Bus Matched Resistance	10
5.3.5 The Second Switch of Function DIP Switch S3 - Setting of gateway starting IDU project number	11
6 Application	12
6.1 Building Management System (BMS)	12

6.2 Topological Graph	13
6.3 Topology Introduction.....	13
7 Product installation	15
7.1 Product Dimension and Installation Space of Electric Control Cabinet	15
7.1.1 Product Dimension.....	15
7.1.2 Installation Dimension of Electric Control Cabinet	16
7.2 Communication Connection	17
7.2.1 Material Selection of Communication Cable.....	18
7.2.2 Communication Connection Way	18
7.2.3 Setting of Communication Connection.....	22
8 Annex: DIP Address.....	25

1 Safety Notices (Please be sure to abide)

	Warning: If not abide strictly, it may cause severe damage to the unit or the people.
	Note: If not abide strictly, it may cause slight or medium damage to the unit or the people.
	This sign indicates that the operation must be prohibited. Improper operation may cause severe damage or death to people.
	This sign indicates that the items must be observed. Improper operation may cause damage to people or property.



WARNING!

This product can't be installed at corrosive, inflammable or explosive environment or the place with special requirements, such as kitchen. Otherwise, it will affect the normal operation or shorten the service life of the unit, or even cause fire hazard or serious injury. As for above special places, please adopt special product with anti-corrosive or anti-explosion function.

2 User Notice

Dear customer :

Please read this manual carefully prior to installation and operation and strictly observe all installation and operation instructions covered in the manual.



WARNING !

(1) Installation shall be performed by the qualified personnel; otherwise it would result in a fire hazard or electric shock.

Modbus Gateway(Mini)

(2)Do not place the plug of the power supply into the socket before it is dried and cleaned.

(3)Cut off the power supply before touching the electric element.

(4)Do not touch this device with wet hands; otherwise it would result in electric shock.

(5)Do use the power cable specified in this manual; otherwise it would result in a fire hazard.

(6)When the power cable is reversely connected or the power supply is beyond the rated range, it would result in a fire hazard or even damages to this device.

(7)Do install this device inside the electric control cabinet which is located indoor and then is locked.

(8)Do install this device where it will not be subject to the electromagnetic interference or heavy dust.



Notice !

(1)Be sure the specified adaptor is used; otherwise this device would work improperly or even be damaged.

(2)Be sure this device is setup in place; otherwise it would result in communication fault.

(3)Be sure the communication line is connected to the correct interface; otherwise it would result in communication fault.

(4)After connection, lines should be protected with insulating tape to avoid oxidation and short circuits.

(5) Normal working conditions for Modbus Gateway(Mini) :

① Temperature : -20 ~ +60°C;

② Humidity: less than 85%;

③ Location: indoor (it is highly recommended to install this product in the electric control cabinet), not subject to direct sunlight, rain and snow etc.

(6) Graphics in the instruction manual are for reference only.

3 General Functions

Gree Modbus Gateway(Mini) is intended to realize the data exchange between the air conditioner and BMS, and provides standard Modbus RTU protocol.

This gateway is applicable for DC Inverter GMV5, Water Source Heat Pump GMV5, GMV5 Mini, GMV5 Slim and GMV5 Heat Recovery.

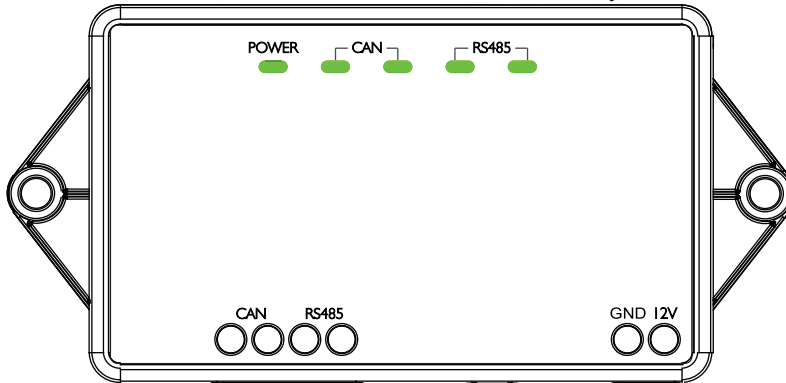

4 Composition

The product contains following items :

Modbus Gateway(Mini)

Modbus Gateway(Mini)	1 set
Owner's Manual	1 set

5 Detailed Introduction of Modbus Gateway(Mini)

5.1 Interface

5.1.1 Interface Function Drawing

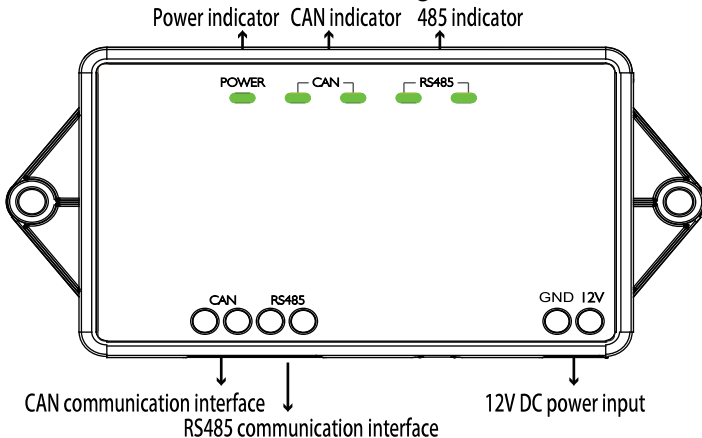

5.1.2 Power

The input power is 12V DC, external power supply can be prepared.

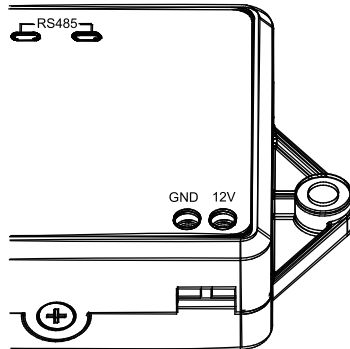

Note: pay attention to the polarity of power input and connect power according to the interface instruction.

5.1.3 Communication Interfaces

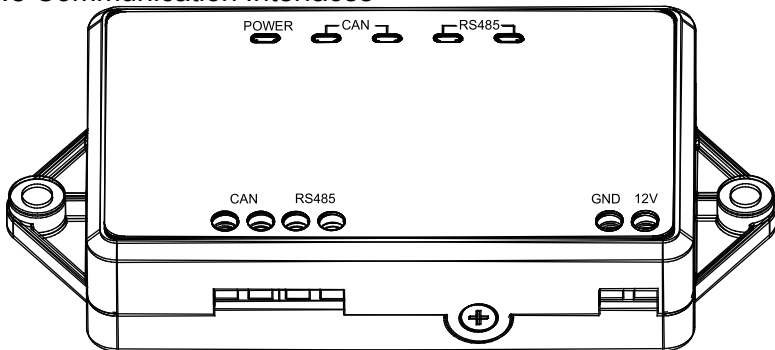

CAN communication interface: It is connected to air conditioner through two-core connection wire, to realize communication between Modbus Gateway(Mini) and air conditioner.

RS485 communication interface: It is connected to BMS through two-core communication cable, to realize communication between Modbus Gateway(Mini) and BMS or nearby Modbus Gateway(Mini).

5.2 LED Display

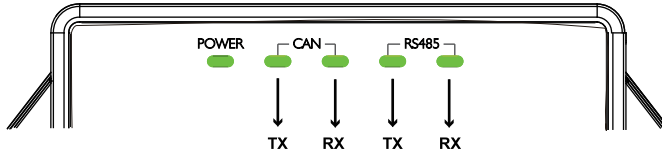

LED indicators shown in the above figure are divided into two parts: status indicators (power) and communication indicators(CAN, RS485). Operation status of each indicator is shown in the following table.

CAN	TX	When the data is transferred to the equipment (e.g. air conditioner) connected with Modbus Gateway(Mini), it will flash.
	RX	When the data from the equipment (e.g. air conditioner) connected with Modbus Gateway(Mini) is received, it will flash.
RS485	TX	When the data is transferred to the Modbus bus, it will flash.
	RX	When the data from the Modbus bus is received, it will flash.
Power		When power supply of Modbus Gateway(Mini) is normal, it will be always on.

5.3 DIP Switches



Notice! Please set DIP switches before using this gateway. Re-energize the device after setting DIP switches.

Otherwise this device cannot operate normally!

Setting area of Modbus gateway DIP switch is located inside the product, including address DIP switch and function DIP switch.

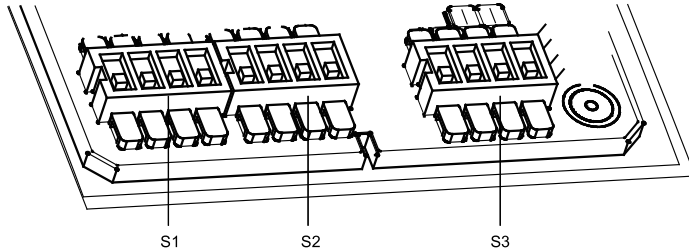

5.3.1 Setting of Address DIP Switch

(1) Address DIP switch consists of S1 and S2. S3 is function DIP switch.

S1

S2

S3

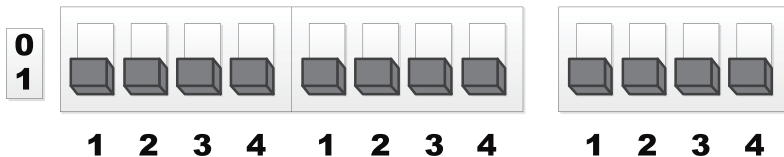

5.3.2 Address DIP Switch S1,S2—Address Setting of Modbus Gateway



Notice! Please set the address DIP switches before using this gateway. The network DIP switch address of the same bus cannot be repeated, otherwise communication error may happen.

Modbus Gateway(Mini) address setting range: 1~255. Detailed DIP value please refer to the Address DIP Form.

Address setting example:

Setting method of address 11 is shown as below:

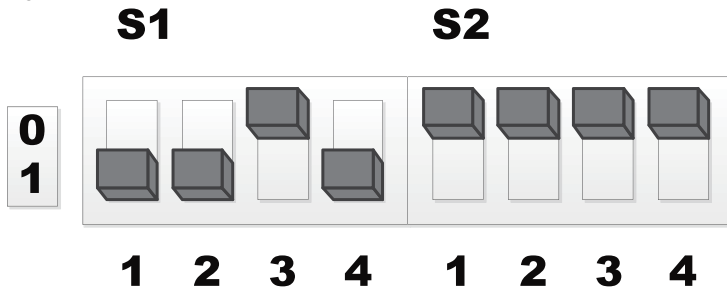

Address								Value
S1				S2				
1	2	3	4	1	2	3	4	
1	1	0	1	0	0	0	0	11

Setting method of address 43 is shown as below:

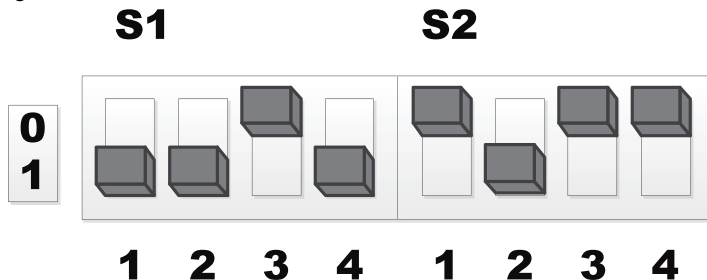

Address								Value
S1				S2				
1	2	3	4	1	2	3	4	
1	1	0	1	0	1	0	0	43

5.3.3 The Fourth Switch of Function DIP Switch S3 - Setting of CAN2 Bus Matched Resistance



Notice!

Notice! Master outdoor unit or gateway of the system which is at the end of CAN2 bus must be set as with the matched resistance, otherwise communication will be abnormal!

The fourth switch of function DIP switch is used for setting the CAN2 bus matched resistance of this gateway.

If the Modbus gateway is at the end of CAN2 bus, the gateway shall be set as with the matched resistance, which means set the fourth DIP switch to 0;

If the Modbus gateway is not at the end of CAN2 bus, the gateway shall be set as without the matched resistance, which means set this DIP switch to 1.

DIP switch of matched resistance is shown as below:

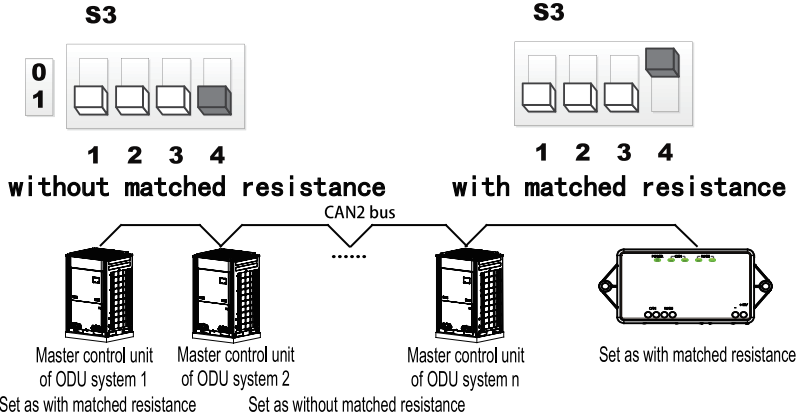

n is ODU system quantity, $n \leq 16$.

5.3.4 The Third Switch of Function DIP Switch S3 - Setting of Modbus Bus Matched Resistance



Notice! The third switch of function DIP switch is used for setting the matched resistance of this gateway in Modbus bus.

Modbus bus: Detailed meaning please refer to topology introduction.

The seventh switch of function DIP switch is used for setting the matched resistance of this gateway in Modbus bus.

If the Modbus gateway is at the end of Modbus bus, the gateway shall be set as with the matched resistance, which means set the third DIP switch to 0;

If the Modbus gateway is not at the end of Modbus bus, the gateway shall be set as without the matched resistance, which means set this DIP switch to 1.

DIP switch of matched resistance is shown as below:



without matched resistance

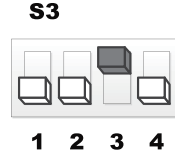

with matched resistance

5.3.5 The Second Switch of Function DIP Switch S3 - Setting of gateway starting IDU project number

Gateway starting IDU project number means the IDU range that this gateway can be handled. The second switch of function DIP switch is used for setting the gateway starting IDU project number.

Gateway starting IDU project number is 1: this gateway can handle the IDU with project number from 1~128.

Gateway starting IDU project number is 129: this gateway can handle the IDU with project number from 129~255.

Setting diagram of gateway starting IDU project number DIP switch:



**Gateway starting IDU
project number is 1**

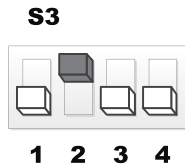

**Gateway starting IDU
project number is 129**

6 Application

Modbus Gateway(Mini) is usually applicable for Building Management System.

6.1 Building Management System (BMS)

This gateway adopts Modbus standard protocol, which can be used as the interface of BMS. It is applicable for DC Inverter GMV5, Water Source Heat Pump GMV5, GMV5 Mini, GMV5 Slim and GMV5 Heat Recovery.

6.2 Topological Graph

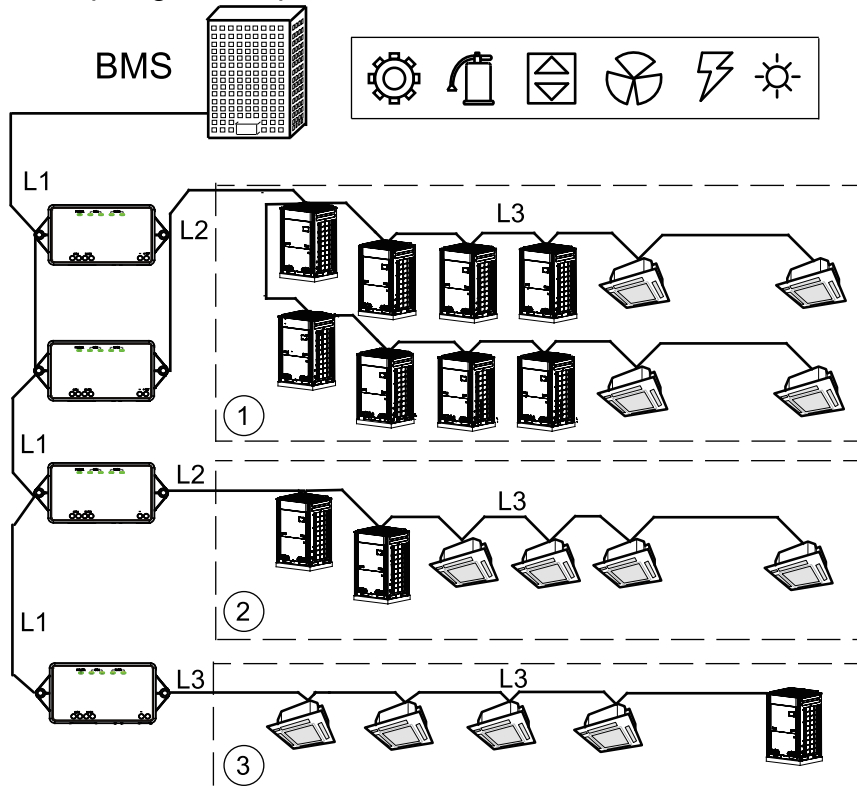

6.3 Topology Introduction

Modbus bus: L1 shown in the figure is the Modbus bus.

Modbus Gateway(Mini)

CAN1 network: network ③ shown in the figure is the CAN1 network, which is consist of Modbus Gateway(Mini) and all IDUs and ODUs of the system. One CAN1 network can be connected to maximum 80 IDUs. L3 shown in the network is CAN1 bus.

CAN2 network: network① and ② shown in the figure is the CAN2 network, which is consist of Modbus Gateway(Mini) and main control ODU of the system. One CAN2 network can be connected to maximum 16 systems and 255 IDUs. If the system quantity exceeds 16 sets or IDU quantity exceeds 255 sets, it shall be divided into two CAN2 network. L2 shown in the figure is CAN2 bus.

System: One system consists of one set of outdoor unit (one set of outdoor unit is a module group consisting of 1~4 modules, that is 1~4 outdoor units) and its connected indoor units.

Connectable unit quantity of Modbus Gateway(Mini): one Modbus Gateway(-Mini) can be connected to maximum 16 systems and 128 IDUs. If IDU quantity exceeds 128 sets, two Modbus gateways are needed.

7 Product installation

7.1 Product Dimension and Installation Space of Electric Control Cabinet

7.1.1 Product Dimension

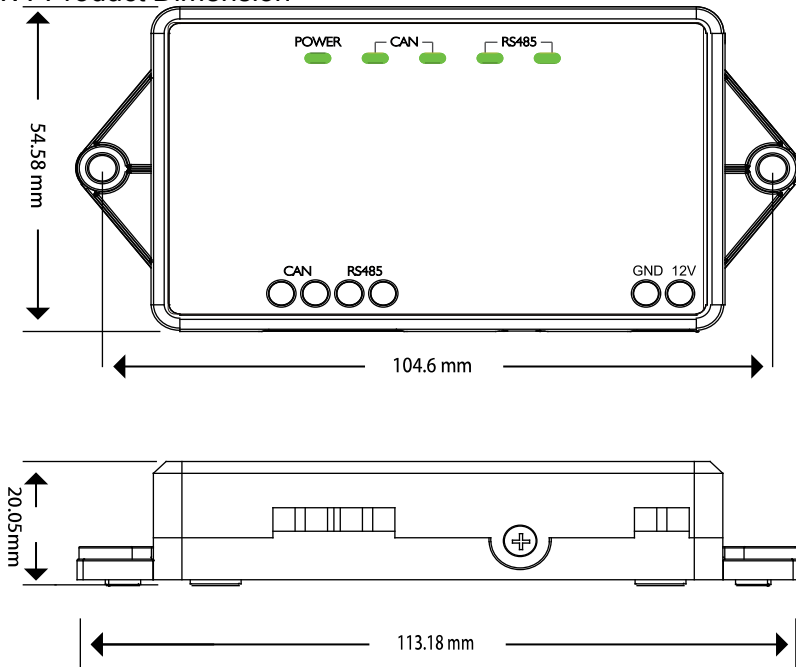

7.1.2 Installation Dimension of Electric Control Cabinet

Modbus Gateway(Mini) shall be installed in the electric control cabinet. The front side of gateway shall be hung upwards in horizontal level and secured by two screws. Required installation space is shown as below (only for reference).

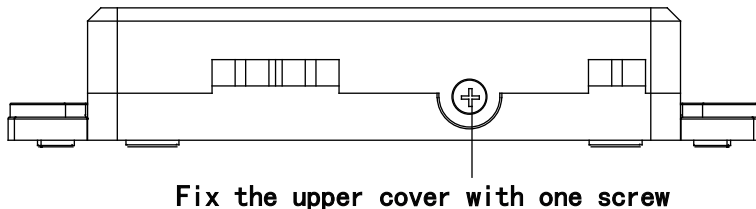
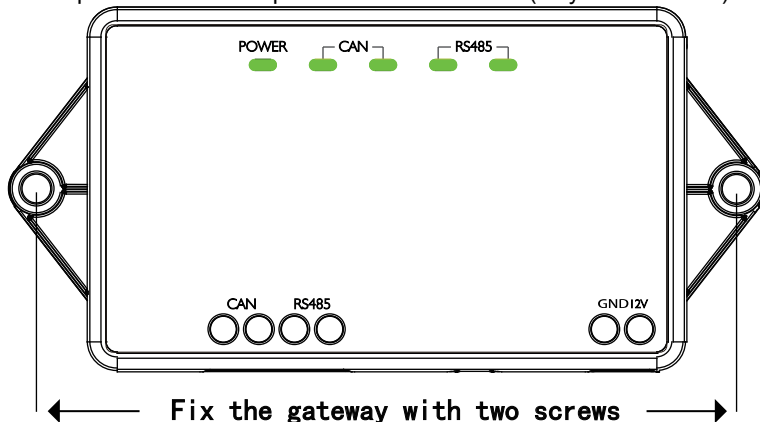

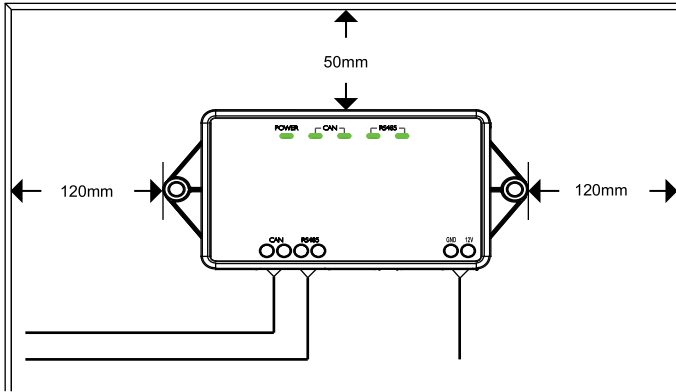

7.2 Communication Connection

Communication system of Modbus Gateway(Mini) includes:

- (1) Communication between Modbus Gateway(Mini) and BMS;
- (2) Communication between Modbus Gateway(Mini) and air conditioner.

7.2.1 Material Selection of Communication Cable

Communication system	Material of cable	Communication cable L(m)	Cable diameter (mm ²)	Material standard	Remark
Communication between Modbus Gateway(-Mini) and BMS	Light/ Ordinary PVC sheathed twisted pair copper wire (RVV)	L≤800	≥2×0.75	IE-C60227-5:2007	When communication distance exceeds 800m, photoelectric isolation repeater shall be added
Communication between Modbus Gateway(-Mini) and air conditioner	Light/ Ordinary PVC sheathed twisted pair copper wire (RVV)	L≤500	≥2×0.75	IE-C60227-5:2007	The length of communication cable shall not exceed 500m

7.2.2 Communication Connection Way



Notice! All communication cables of Modbus Gateway(Mini) must be connected in series instead of in star mode.

(1) Communicaiton connection between Modbus Gateway(Mini) and BMS;

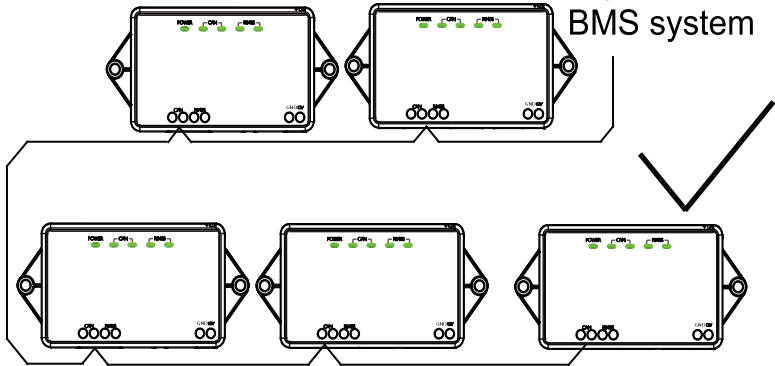

Modbus Gateway(Mini)

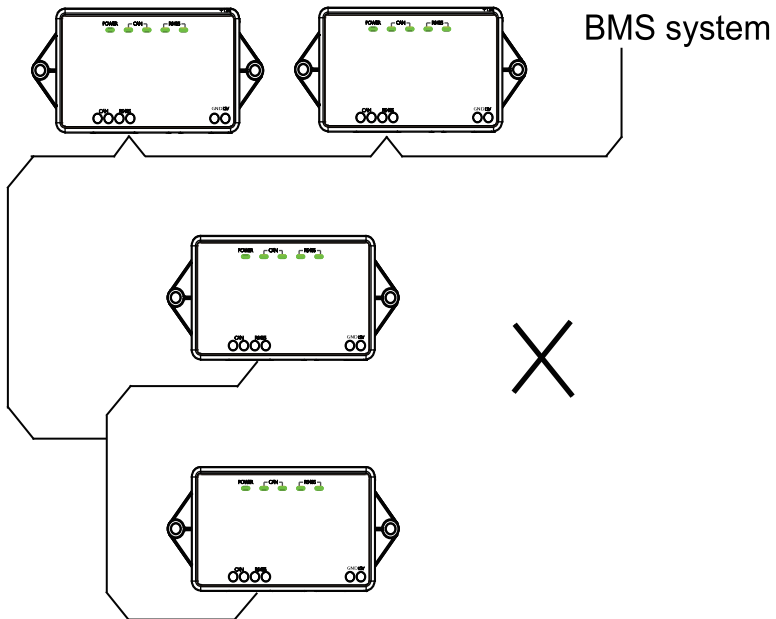

(2) Communication connection between Modbus Gateway(Mini) and air conditioner (n is air conditioner quantity, $n \leq 16$);

Modbus Gateway(Mini)

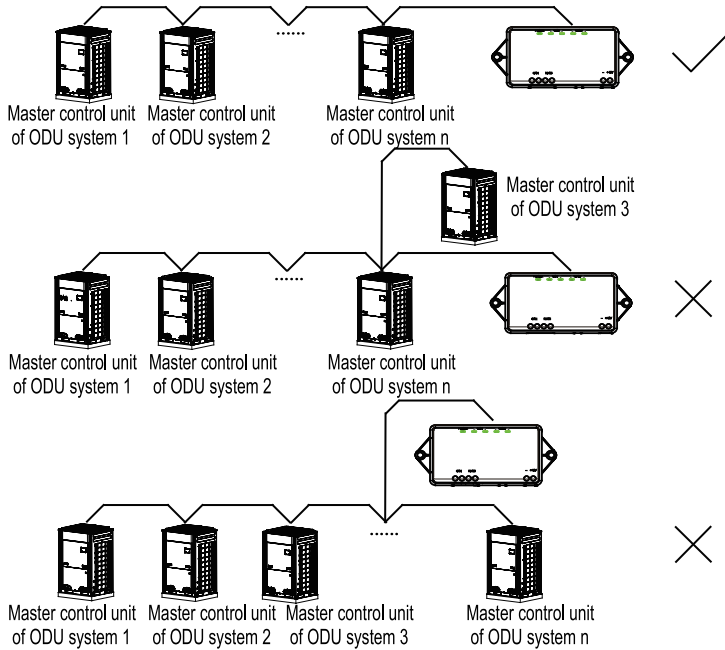

7.2.3 Setting of Communication Connection

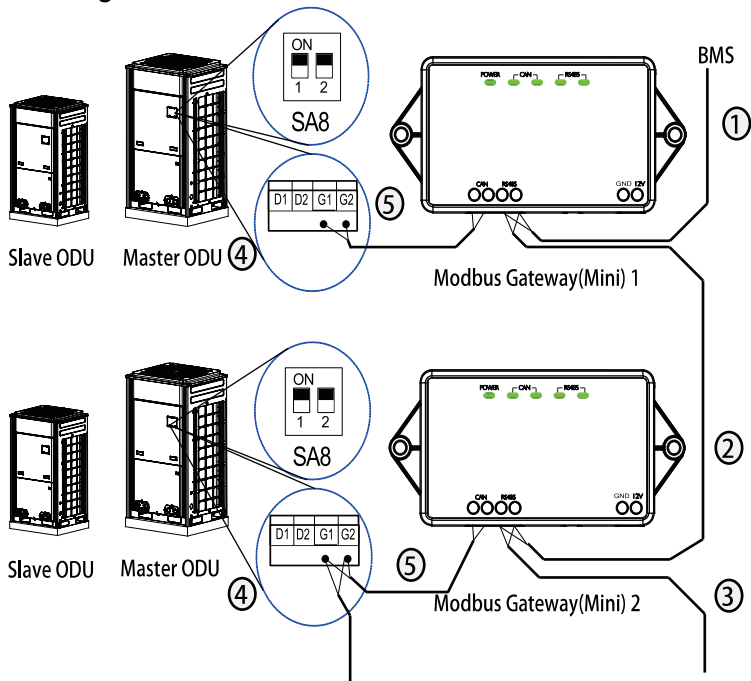

(1) Communication wire connection between Modbus Gateway(Mini) and BMS:

Step 1: Confirm the first Modbus Gateway(Mini) (Modbus Gateway(Mini)1 as shown in the figure) that needs to be connected to BMS. Connect the port of RS485 of this gateway and the BMS with communication cable, as shown in step ① in the figure.

Step 2: Connect the RS485 communication port of Modbus Gateway(Mini) (- Modbus Gateway(Mini)1) with the RS485 communication port of the second Modbus Gateway(Mini) (Modbus Gateway(Mini)2 as shown in the figure) with communication cable; as shown in step ② in the figure.

Step 3: The other Modbus Gateway(Mini) shall be connected in series; as shown in step ③ in the figure.

(2) Communication wire connection between Modbus Gateway(Mini) and air conditioner:

Step 1: Confirm the master ODU that each Modbus Gateway(Mini) shall be connected (set master ODU with SA8 DIP). Please refer to “7.2.2(2) Communicaiton connection between Modbus Gateway(Mini) and air conditioner” and adopt series connection, as shown in step ④ in the figure.

Step 2: Connect the G1 and G2 port of CAN communication interface of Modbus Gateway(Mini) and the G1 and G2 port of wiring board of corresponding master ODU with communication cable, as shown in step ⑤ in the figure.

※ CAN2 network: Detailed meaning please refer to topology introduction.

(3) Modbus Gateway(Mini) DIP setting:

Step one: Set address DIP of Modbus Gateway(Mini);

Step two: Refer to Chapter 5.3.4 to set matching resistance of Modbus Gateway (Mini);

Note:

1. In Modbus bus, if the connected Modbus Gateway(Mini) exceeds 30 or communication distance exceeds 800m, one photoelectric isolation repeater shall be added. Connect the R+ and R- port of photoelectric isolation repeater with the R + and R- port of RS485 communication port of nearby Modbus Gateway(Mini).

30 Modbus gateways in maximum between two repeaters

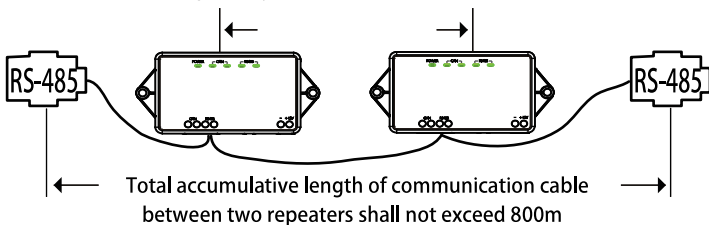

2. In “5.3.3 The fourth switch of DIP switch S3—setting of CAN2 bus matched resistance”, the setting method of matched resistance of Modbus Gateway(Mini) is introduced. Meanwhile, the master ODU in the first and end systems of CAN2 bus shall be set as with matched resistance. In the following, the detailed setting position and method of matched resistance of GMV5 DC inverter multi VRF are taken as example.

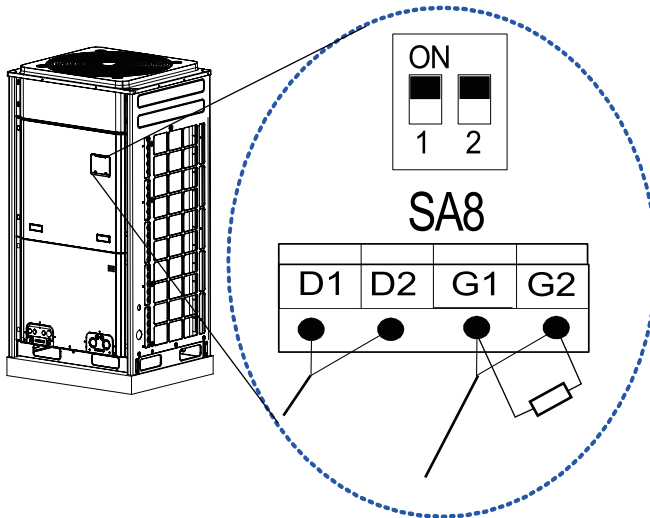

※ CAN2 bus: Detailed meaning please refer to topology introduction.

8 Annex: DIP Address

0~31 DIP address table								
S1				S2				a-d-dr
1	2	3	4	1	2	3	4	
0	0	0	0	0	0	0	0	/
1	0	0	0	0	0	0	0	1
0	1	0	0	0	0	0	0	2

32~63 DIP address table								
S1				S2				ad-dr
1	2	3	4	1	2	3	4	
0	0	0	0	0	1	0	0	32
1	0	0	0	0	1	0	0	33
0	1	0	0	0	1	0	0	34

Modbus Gateway(Mini)

1	1	0	0	0	0	0	0	3	1	1	0	0	0	1	0	0	35
0	0	1	0	0	0	0	0	4	0	0	1	0	0	1	0	0	36
1	0	1	0	0	0	0	0	5	1	0	1	0	0	1	0	0	37
0	1	1	0	0	0	0	0	6	0	1	1	0	0	1	0	0	38
1	1	1	0	0	0	0	0	7	1	1	1	0	0	1	0	0	39
0	0	0	1	0	0	0	0	8	0	0	0	1	0	1	0	0	40
1	0	0	1	0	0	0	0	9	1	0	0	1	0	1	0	0	41
0	1	0	1	0	0	0	0	10	0	1	0	1	0	1	0	0	42
1	1	0	1	0	0	0	0	11	1	1	0	1	0	1	0	0	43
0	0	1	1	0	0	0	0	12	0	0	1	1	0	1	0	0	44
1	0	1	1	0	0	0	0	13	1	0	1	1	0	1	0	0	45
0	1	1	1	0	0	0	0	14	0	1	1	1	0	1	0	0	46
1	1	1	1	0	0	0	0	15	1	1	1	1	0	1	0	0	47
0	0	0	0	1	0	0	0	16	0	0	0	0	1	1	0	0	48
1	0	0	0	1	0	0	0	17	1	0	0	0	1	1	0	0	49
0	1	0	0	1	0	0	0	18	0	1	0	0	1	1	0	0	50
1	1	0	0	1	0	0	0	19	1	1	0	0	1	1	0	0	51
0	0	1	0	1	0	0	0	20	0	0	1	0	1	1	0	0	52
1	0	1	0	1	0	0	0	21	1	0	1	0	1	1	0	0	53
0	1	1	0	1	0	0	0	22	0	1	1	0	1	1	0	0	54

1	1	1	0	1	0	0	0	23	1	1	1	0	1	1	0	0	55
0	0	0	1	1	0	0	0	24	0	0	0	1	1	1	0	0	56
1	0	0	1	1	0	0	0	25	1	0	0	1	1	1	0	0	57
0	1	0	1	1	0	0	0	26	0	1	0	1	1	1	0	0	58
1	1	0	1	1	0	0	0	27	1	1	0	1	1	1	0	0	59
0	0	1	1	1	0	0	0	28	0	0	1	1	1	1	0	0	60
1	0	1	1	1	0	0	0	29	1	0	1	1	1	1	0	0	61
0	1	1	1	1	0	0	0	30	0	1	1	1	1	1	0	0	62
1	1	1	1	1	0	0	0	31	1	1	1	1	1	1	0	0	63

64~95 DIP address table									96~127 DIP address table								
S1				S2				a-d-dr	S1				S2				a-d-dr
1	2	3	4	5	6	7	8		1	2	3	4	5	6	7	8	
0	0	0	0	0	0	1	0	64	0	0	0	0	0	1	1	0	96
1	0	0	0	0	0	1	0	65	1	0	0	0	0	1	1	0	97
0	1	0	0	0	0	1	0	66	0	1	0	0	0	1	1	0	98
1	1	0	0	0	0	1	0	67	1	1	0	0	0	1	1	0	99
0	0	1	0	0	0	1	0	68	0	0	1	0	0	1	1	0	100
1	0	1	0	0	0	1	0	69	1	0	1	0	0	1	1	0	101
0	1	1	0	0	0	1	0	70	0	1	1	0	0	1	1	0	102

Modbus Gateway(Mini)

1	1	1	0	0	0	1	0	71	1	1	1	0	0	1	1	0	103
0	0	0	1	0	0	1	0	72	0	0	0	1	0	1	1	0	104
1	0	0	1	0	0	1	0	73	1	0	0	1	0	1	1	0	105
0	1	0	1	0	0	1	0	74	0	1	0	1	0	1	1	0	106
1	1	0	1	0	0	1	0	75	1	1	0	1	0	1	1	0	107
0	0	1	1	0	0	1	0	76	0	0	1	1	0	1	1	0	108
1	0	1	1	0	0	1	0	77	1	0	1	1	0	1	1	0	109
0	1	1	1	0	0	1	0	78	0	1	1	1	0	1	1	0	110
1	1	1	1	0	0	1	0	79	1	1	1	1	0	1	1	0	111
0	0	0	0	1	0	1	0	80	0	0	0	0	1	1	1	0	112
1	0	0	0	1	0	1	0	81	1	0	0	0	1	1	1	0	113
0	1	0	0	1	0	1	0	82	0	1	0	0	1	1	1	0	114
1	1	0	0	1	0	1	0	83	1	1	0	0	1	1	1	0	115
0	0	1	0	1	0	1	0	84	0	0	1	0	1	1	1	0	116
1	0	1	0	1	0	1	0	85	1	0	1	0	1	1	1	0	117
0	1	1	0	1	0	1	0	86	0	1	1	0	1	1	1	0	118
1	1	1	0	1	0	1	0	87	1	1	1	0	1	1	1	0	119
0	0	0	1	1	0	1	0	88	0	0	0	1	1	1	1	0	120
1	0	0	1	1	0	1	0	89	1	0	0	1	1	1	1	0	121
0	1	0	1	1	0	1	0	90	0	1	0	1	1	1	1	0	122

1	1	0	1	1	0	1	0	91	1	1	0	1	1	1	1	0	123
0	0	1	1	1	0	1	0	92	0	0	1	1	1	1	1	0	124
1	0	1	1	1	0	1	0	93	1	0	1	1	1	1	1	0	125
0	1	1	1	1	0	1	0	94	0	1	1	1	1	1	1	0	126
1	1	1	1	1	0	1	0	95	1	1	1	1	1	1	1	0	127

128~159 DIP address table								
S1				S2				ad- dr
1	2	3	4	1	2	3	4	
0	0	0	0	0	0	0	1	128
1	0	0	0	0	0	0	1	129
0	1	0	0	0	0	0	1	130
1	1	0	0	0	0	0	1	131
0	0	1	0	0	0	0	1	132
1	0	1	0	0	0	0	1	133
0	1	1	0	0	0	0	1	134
1	1	1	0	0	0	0	1	135
0	0	0	1	0	0	0	1	136
1	0	0	1	0	0	0	1	137
0	1	0	1	0	0	0	1	138
1	1	0	1	0	0	0	1	139

160~191 DIP address table								
S1				S2				ad- dr
1	2	3	4	1	2	3	4	
0	0	0	0	0	1	0	1	160
1	0	0	0	0	1	0	1	161
0	1	0	0	0	1	0	1	162
1	1	0	0	0	1	0	1	163
0	0	1	0	0	1	0	1	164
1	0	1	0	0	1	0	1	165
0	1	1	0	0	1	0	1	166
1	1	1	0	0	1	0	1	167
0	0	0	1	0	1	0	1	168
1	0	0	1	0	1	0	1	169
0	1	0	1	0	1	0	1	170
1	1	0	1	0	1	0	1	171

Modbus Gateway(Mini)

0	0	1	1	0	0	0	1	140	0	0	1	1	0	1	0	1	172
1	0	1	1	0	0	0	1	141	1	0	1	1	0	1	0	1	173
0	1	1	1	0	0	0	1	142	0	1	1	1	0	1	0	1	174
1	1	1	1	0	0	0	1	143	1	1	1	1	0	1	0	1	175
0	0	0	0	1	0	0	1	144	0	0	0	0	1	1	0	1	176
1	0	0	0	1	0	0	1	145	1	0	0	0	1	1	0	1	177
0	1	0	0	1	0	0	1	146	0	1	0	0	1	1	0	1	178
1	1	0	0	1	0	0	1	147	1	1	0	0	1	1	0	1	179
0	0	1	0	1	0	0	1	148	0	0	1	0	1	1	0	1	180
1	0	1	0	1	0	0	1	149	1	0	1	0	1	1	0	1	181
0	1	1	0	1	0	0	1	150	0	1	1	0	1	1	0	1	182
1	1	1	0	1	0	0	1	151	1	1	1	0	1	1	0	1	183
0	0	0	1	1	0	0	1	152	0	0	0	1	1	1	0	1	184
1	0	0	1	1	0	0	1	153	1	0	0	1	1	1	0	1	185
0	1	0	1	1	0	0	1	154	0	1	0	1	1	1	0	1	186
1	1	0	1	1	0	0	1	155	1	1	0	1	1	1	0	1	187
0	0	1	1	1	0	0	1	156	0	0	1	1	1	1	0	1	188
1	0	1	1	1	0	0	1	157	1	0	1	1	1	1	0	1	189
0	1	1	1	1	0	0	1	158	0	1	1	1	1	1	0	1	190
1	1	1	1	1	0	0	1	159	1	1	1	1	1	1	0	1	191

192~223 DIP address table									224~255 DIP address table								
S1				S2				ad-dr	S1				S2				ad-dr
1	2	3	4	5	6	7	8		1	2	3	4	5	6	7	8	
0	0	0	0	0	0	1	1	192	0	0	0	0	0	1	1	1	224
1	0	0	0	0	0	1	1	193	1	0	0	0	0	1	1	1	225
0	1	0	0	0	0	1	1	194	0	1	0	0	0	1	1	1	226
1	1	0	0	0	0	1	1	195	1	1	0	0	0	1	1	1	227
0	0	1	0	0	0	1	1	196	0	0	1	0	0	1	1	1	228
1	0	1	0	0	0	1	1	197	1	0	1	0	0	1	1	1	229
0	1	1	0	0	0	1	1	198	0	1	1	0	0	1	1	1	230
1	1	1	0	0	0	1	1	199	1	1	1	0	0	1	1	1	231
0	0	0	1	0	0	1	1	200	0	0	0	1	0	1	1	1	232
1	0	0	1	0	0	1	1	201	1	0	0	1	0	1	1	1	233
0	1	0	1	0	0	1	1	202	0	1	0	1	0	1	1	1	234
1	1	0	1	0	0	1	1	203	1	1	0	1	0	1	1	1	235
0	0	1	1	0	0	1	1	204	0	0	1	1	0	1	1	1	236
1	0	1	1	0	0	1	1	205	1	0	1	1	0	1	1	1	237
0	1	1	1	0	0	1	1	206	0	1	1	1	0	1	1	1	238
1	1	1	1	0	0	1	1	207	1	1	1	1	0	1	1	1	239
0	0	0	0	1	0	1	1	208	0	0	0	0	1	1	1	1	240

Modbus Gateway(Mini)

1	0	0	0	1	0	1	1	209	1	0	0	0	1	1	1	1	241
0	1	0	0	1	0	1	1	210	0	1	0	0	1	1	1	1	242
1	1	0	0	1	0	1	1	211	1	1	0	0	1	1	1	1	243
0	0	1	0	1	0	1	1	212	0	0	1	0	1	1	1	1	244
1	0	1	0	1	0	1	1	213	1	0	1	0	1	1	1	1	245
0	1	1	0	1	0	1	1	214	0	1	1	0	1	1	1	1	246
1	1	1	0	1	0	1	1	215	1	1	1	0	1	1	1	1	247
0	0	0	1	1	0	1	1	216	0	0	0	1	1	1	1	1	248
1	0	0	1	1	0	1	1	217	1	0	0	1	1	1	1	1	249
0	1	0	1	1	0	1	1	218	0	1	0	1	1	1	1	1	250
1	1	0	1	1	0	1	1	219	1	1	0	1	1	1	1	1	251
0	0	1	1	1	0	1	1	220	0	0	1	1	1	1	1	1	252
1	0	1	1	1	0	1	1	221	1	0	1	1	1	1	1	1	253
0	1	1	1	1	0	1	1	222	0	1	1	1	1	1	1	1	254
1	1	1	1	1	0	1	1	223	1	1	1	1	1	1	1	1	255



GREE ELECTRIC APPLIANCES, INC. OF ZHUHAI

Add: West Jinji Rd, Qianshan, Zhuhai, Guangdong, China, 519070

Tel: (+86-756) 8522218

Fax: (+86-756) 8669426

E-mail: gree@gree.com.cn www.gree.com



600005060541