



Owner's Manual

Original Instructions

VRF Protocol Gateway

Model:
ME30-24/D1(BM)

Thank you for choosing this product. Please read this Owner's Manual carefully before operation and retain it for future reference.

If you have lost the Owner's Manual, please contact the local agent or visit www.gree.com or send an email to global@cn.gree.com for the electronic version.

GREE ELECTRIC APPLIANCES, INC. OF ZHUHAI

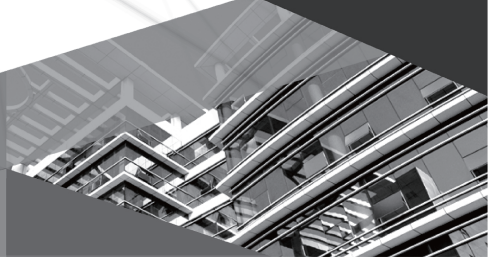

To Users

Thank you for selecting Gree product. Before installing the product, please read this instruction manual carefully to know well about the product and use it correctly. In order to install and use the product correctly to reach the expected operational effect, the following instructions are hereby issued:

(1) The appliance is not intended to be used by the people with physical, sensory or mental handicap or the people without using experience and knowledge (including children), except that they are supervised or guided by a person responsible for their safety when using the appliance. Children should be supervised to ensure that they do not play with the appliance.

(2) This instruction manual is universal manual, some functions introduced in this manual are only applicable to specific products; all the illustrations and information in this manual are only for reference, and the control interface should be subject to the actual interface.

(3) In order to better meet the customers' demand, our company will improve the product continuously and we have the right to conduct necessary modification at any time due to the reason of sales or production, and will reserve the right of modification without further notification.

(4) We will bear no responsibility for the personal injury, property loss or damage of equipment due to improper installation and debugging, unnecessary maintenance, non-observance of related national laws, regulations, and industrial standards, violation of any stipulations of this instruction manual, etc.

(5) The final authority for the interpretation of this instruction manual belongs to Gree Electric Appliances, Inc. of Zhuhai.

Contents

1 Safety Notices (Please be sure to abide)	1
2 User Notice	1
3 Function and Parameter	2
3.1 Functional Overview	2
3.2 Parameter Specifications	3
4 Parts and Assembly	3
5 Introduction for Gateway	3
5.1 Interface	3
5.2 LED Display	4
5.3 Button.....	5
5.4 DIP Switch.....	5
6 Application	8
6.1 Building Management System (BMS)	8
6.2 Internet Topological Graph	8
7 Product Installation	10
7.1 Product Size and Spatial Size for Electric Control Cabinet Installation	10
7.2 Gateway and BMS adopt Modbus RTU Protocol Communication Connecting Method	11
7.3 Gateway and BMS adopt Modbus RTU Protocol Communication Connecting Method	14
8 BACnet Protocol	21
8.1 Structure of BACnet Protocol	21
8.2 Object and Property of BACnet Protocol	21
9 Attachment A TCP/IP Setting	23

1 Safety Notices (Please be sure to abide)



WARNING: If not abide strictly, it may cause severe damage to the unit or the people.



NOTICE: If not abide strictly, it may cause slight or medium damage to the unit or the people.



This sign indicates that the operation must be prohibited. Improper operation may cause severe damage or death to people.



This sign indicates that the items must be observed. Improper operation may cause damage to people or property.



WARNING!



This product can't be installed at corrosive, inflammable or explosive environment or the place with special requirements, such as kitchen. Otherwise, it will affect the normal operation or shorten the service life of the unit, or even cause fire hazard or serious injury. As for above special places, please adopt special air conditioner with anti-corrosive or anti-explosion function.

2 User Notice

Dear customer:

Please read this manual carefully prior to installation and operation and strictly observe all installation and operation instructions covered in the manual.

Special attentions shall be paid to the following marks:

 WARNING!	This mark indicates operation, which if improperly performed, might lead to the death or serious injury of the users.
 CAUTION!	This mark indicates operation, which if improperly performed, might possibly result in damage to the device.

 WARNING!	
(1)	Installation shall be performed by the qualified personnel; otherwise it would result in a fire hazard or electric shock.
(2)	Do not place the plug of the power supply into the socket before it is dried and cleaned.
(3)	Cut off the power supply before touching the electric element.

VRF Protocol Gateway

WARNING!

- (4) Do not touch this device with wet hands; otherwise it would result in electric shock.
- (5) Do use the power cable specified in this manual; otherwise it would result in a fire hazard.
- (6) When the power cable is reversely connected or the power supply is beyond the rated range, it would result in a fire hazard or even damages to this device.
- (7) For PLUGGABLE EQUIPMENT, the socket-outlet shall be installed near the equipment and shall be easily accessible.
- (8) Do install this device inside the electric control cabinet which is located indoor and then is locked.
- (9) Do install this device where it will not be subject to the electromagnetic interference or heavy dust.

CAUTION!

- (1) Be sure the specified adaptor is used; otherwise this device would work improperly or even be damaged.
- (2) Be sure this device is setup in place; otherwise it would result in communication fault.
- (3) Be sure the communication line is connected to the correct interface; otherwise it would result in communication fault.
- (4) After connection, lines should be protected with insulating tape to avoid oxidation and short circuits.
- (5) Risk of explosion if battery is replaced by an incorrect type, dispose of used batteries according to the instructions.
- (6) Normal working conditions for Gateway:
 - ①Temperature : -20~60°C;
 - ②Humidity: less than 85%,except for the condensation of dew;
 - ③Location: indoor (it is highly recommended to install this product in the electric control cabinet), not subject to direct sunlight, rain and snow etc.
- (7) Graphics in the instruction manual are for reference only.

3 Function and Parameter

3.1 Functional Overview

Gree protocol gateway ME30-24/D1(BM) for multi VRF unit can realize data

exchange between air conditioner and BMS system and provide building interfaces for standard Modbus RTU, Modbus TCP and BACnet/IP. This gateway is applicable to the Gree multi VRF unit that uses CAN protocol.

Note: The Gateway ME30-24/D1(BM) of multi VRF unit in the following will be called gateway for short.

3.2 Parameter Specifications

3.2.1 Gateway TCP/IP Parameter (Default)

IP Address: 192.168.1.150

Subnet Mask: 255.255.255.0

Default gateway: 192.168.1.1

! CAUTION: After the TCP/IP parameters are altered, the gateway should be restarted, then the parameters can come into effect.

4 Parts and Assembly

This kit includes the following parts. Please check before installation.

Gateway	1 set
Instruction manual	1 set

5 Introduction for Gateway

5.1 Interface

5.1.1 Diagram of Interface Function

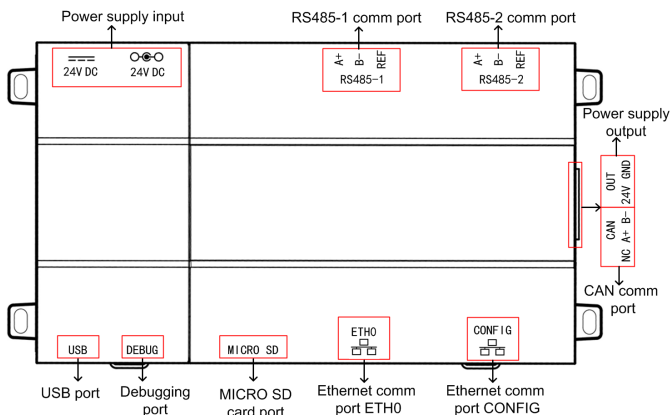

Fig. 5.1 Schematic of protocol gateway interfaces of multi VRF unit

5.1.2 Power

The input power supply is 24V DC, there are two power supply input interfaces, only one is needed during operation; the power supply output is not applicable in this device, please do not connect to electric appliance, otherwise it may cause malfunction of gateway.

5.1.3 Communication Interface

CAN comm port: connect it to the AC unit through the 2-core communication line to realize the communication between Gateway and the AC which adopts CAN protocol.

RS485-1 comm port: connect to the BMS terminal through a two-core communication line to realize the communication connection between the gateway and the BMS terminal or the connection between adjacent gateways.

RS485-2 comm port: this device will not use this communication interface temporarily.

USB and SD card port: this device will not use this interface temporarily.

Ethernet comm port ETH0: realize communication through network cable and BMS.

Ethernet comm port CONFIG: this device will not use this interface temporarily.

5.2 LED Display

As shown in the picture below, open the black transparent front panel.

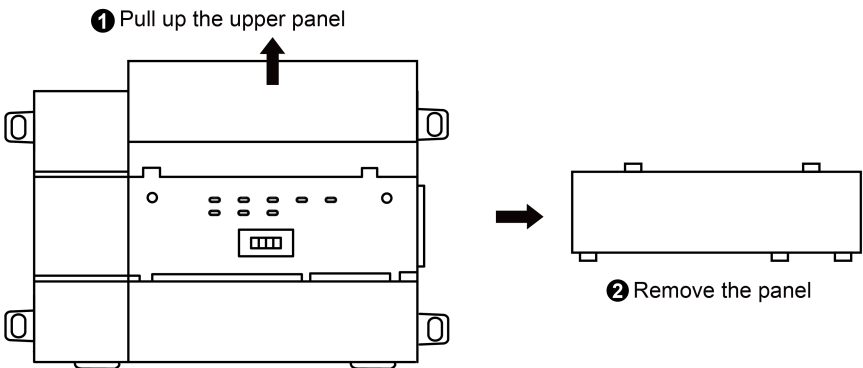

Fig 5.2 Schematic diagram of opening the black transparent board

Indicators, buttons and DIP switch are as shown below.

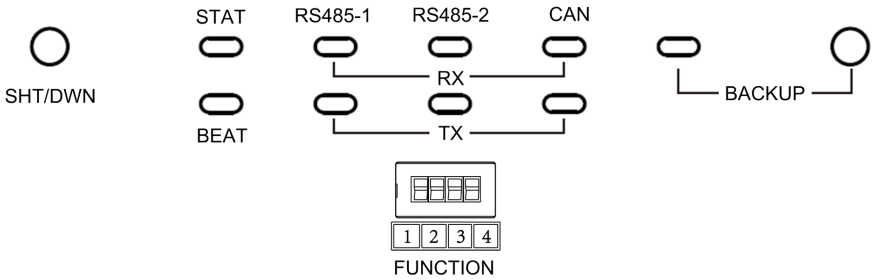

Fig 5.3 The schematic diagram of the gateway LED light board and DIP switch

The above LED indicator is mainly consist of two parts: status indicator (run, power) and communication indicator (CAN and RS485). The following table is the working status of each indicator.

CAN	RX	When receiving the data of equipment (eg. AC unit) which connects to gateway, it blinks.
	TX	When transmitting data to the equipment (eg. AC unit) which connects to gateway, it blinks.
RS485-1	RX	When the gateway receives data on the 485 bus, it blinks.
	TX	When the gateway sends data to the 485 bus, it blinks.
RS485-2	RX	This device does not use this LED indicator.
	TX	This device does not use this LED indicator.
STAT		When power supply of Gateway is normal, it is on.
BEAT		When Gateway is running normally, it blinks.
BACKUP		This device does not use this LED indicator.

5.3 Button

SHT/DWN	When the fourth digit of DIP switch code is “1”, hold the button for 5s and all indicators will be on. Reset the gateway controller.
BACKUP	Not use this button for this device temporarily.

5.4 DIP Switch

! NOTICE!

Before using this device, please conduct DIP switch setting first, otherwise the unit will not function normally!

Gateway dial-up setting area is consisting of function DIP switch code.

5.4.1 Diagram of Dial-up Machine

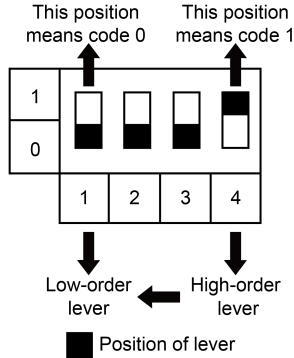

5.4.2 The 1st Level of Functional DIP Switch—CAN2 Bus Matched Resistance Setting

NOTICE! Main control ODU or gateway at the top/end of CAN2 bus must be with matched resistance; otherwise the communication might be wrong!

※ CAN2 bus: Specific meaning shall refer to the specification in Fig Internet topological graph.

The No.1 dial-up button in function dial-up machine shall be used in the setting in the matched resistance of CAN2 bus in this gateway.

When the gateway is at the top/end of CAN2 bus, the gateway shall be with the matched resistance, then dial the No.1 function dial-up machine to 1.

When the gateway is not at the top/end of CAN2 bus, the gateway is not with the matched resistance, then dial it to 0.

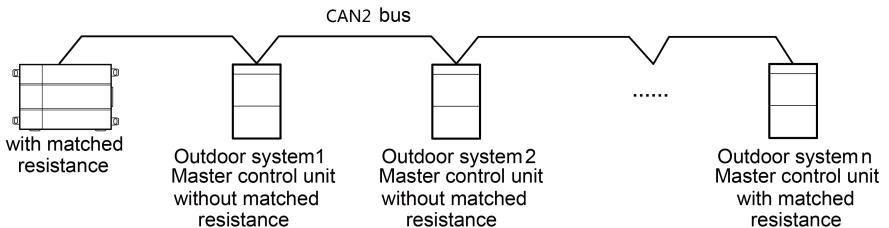

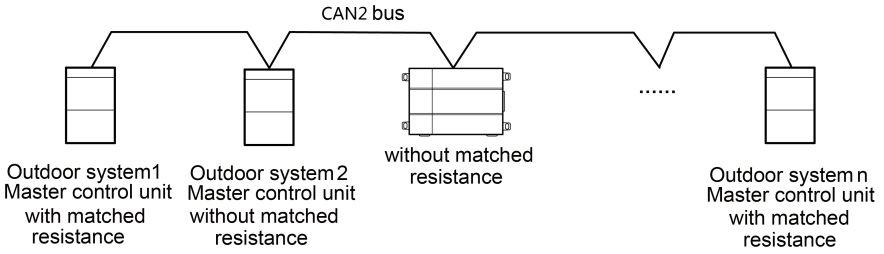

Fig. 5.4 Gateway access CAN2 network matching resistance setting

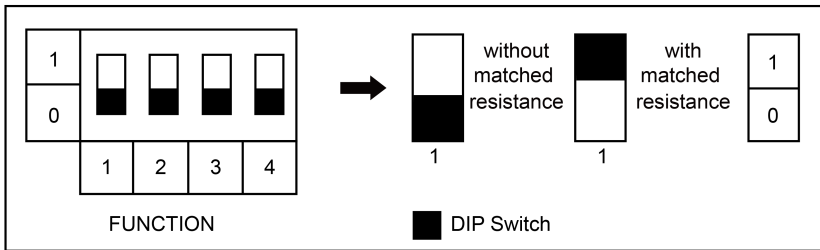

Fig. 5.5 Schematic of dial code

5.4.3 The 2st Level of Functional DIP Switch—485 Bus Matched Resistance Setting

The 2nd dial code of the function dialer is used for setting the matching resistance of the gateway of 485 bus.

When the controller is at the beginning/end of the 485 bus, the controller needs to be set to be with matching resistance, then the second bit of function dialer is set to 1; when the controller is not at the beginning/end of the 485 bus, set the controller to be without matching resistance, and set the dial code to 0.

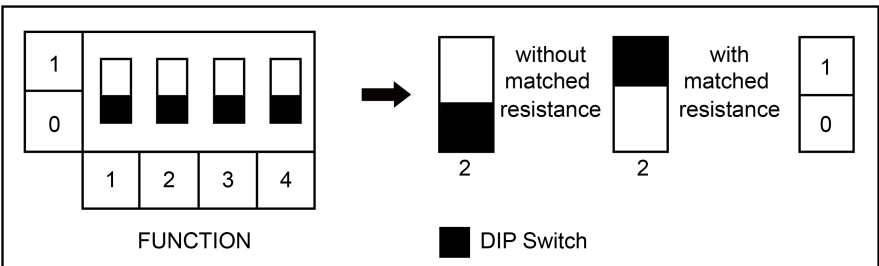

Fig. 5.6 Schematic of dial code

5.4.4 The 4st Lever of Functional DIP Switch—Gateway Reset Selection Bits

When there's an error in configuring Gateway IP address, subnet mask, default gateway, gateway name or gateway ID from the webpage, and the webpage can't be accessed, user can reset the gateway to restore factory default information. Dial the fourth digit of the DIP switch code to "1", hold SHT/DWN button for 5s to restore the default information of factory setting of the gateway.

6 Application

6.1 Building Management System (BMS)

This gateway has provided Modbus RTU, Modbus TCP and BACnet standard protocols, which can connect to building management system (BMS). Realizing the monitoring of Gree units of CAN bus by building management system through gateway.

6.2 Internet Topological Graph

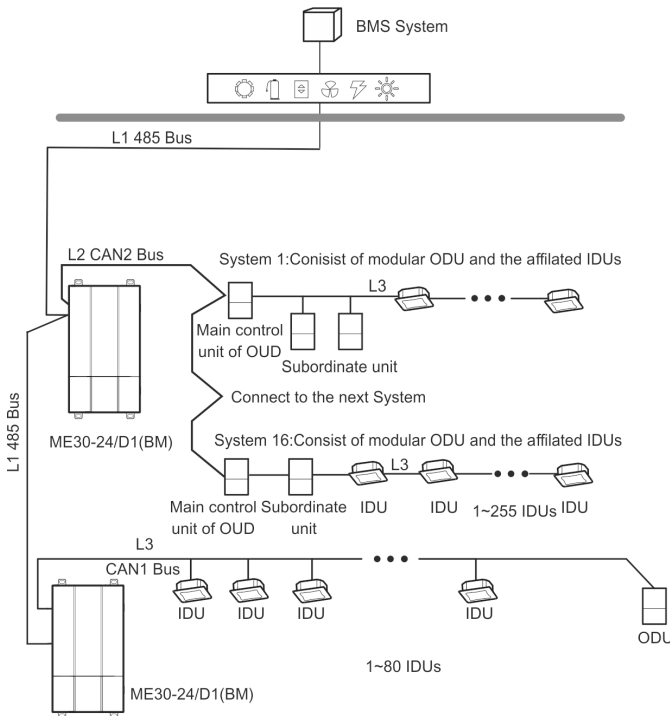

Fig. 6.1 Network topology for communication method of Modbus RTU

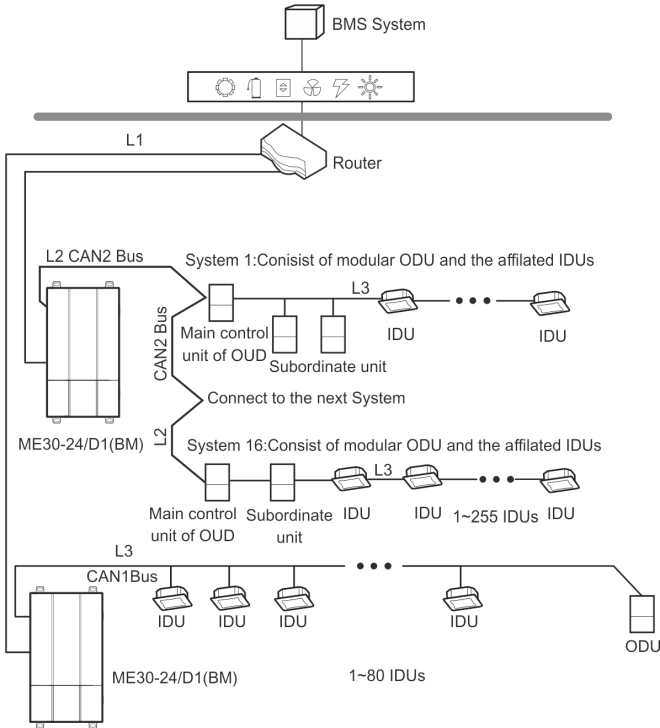

Fig. 6.2 Communication method of BACnet and communication method network topology of Modbus TCP

Internet topological graph statement:

485 bus: L1 shown in Fig. 6.1 is 485 bus, one 485 bus can connect to 254 gateways at most.

Network table: L1 shown in Fig. 6.2 is general network cable, the gateway can connect to BMS via the network cable.

CAN1 network: L3 shown in Fig. 6.2 is CAN1 bus, which consists of network and all the outdoor units and indoor units of system; one CAN1 network can connect to 80 sets of indoor units at most.

CAN2 network: L2 shown in Fig. 6.2 is CAN2 bus, which consists of gateway and master outdoor unit of system; one CAN2 network can connect to 16 sets of outdoor units and 255 sets of indoor units. When the quantity of outdoor units exceeds 16 or the quantity of indoor units exceeds 255, it should be divided into two CAN2 networks.

System: One system consists of one set of outdoor unit (one set of outdoor unit is a module set, which can consist of 1~4 modules, that is, 1~4 sets of outdoor units) and its indoor unit.

Connectable quantity of units of gateway: One gateway can connect to 16 sets of outdoor units and 255 sets of indoor units at most.

Remarks:

(1) One 485 bus can connect to 254 gateways at most, if there are other 485 equipment in the 485 bus, the connectable gateway should reduce accordingly.

(2) It is recommended that the connecting quantity of gateway of 485 bus is less or equal to 16.

7 Product Installation

7.1 Product Size and Spatial Size for Electric Control Cabinet Installation

7.1.1 Product Size

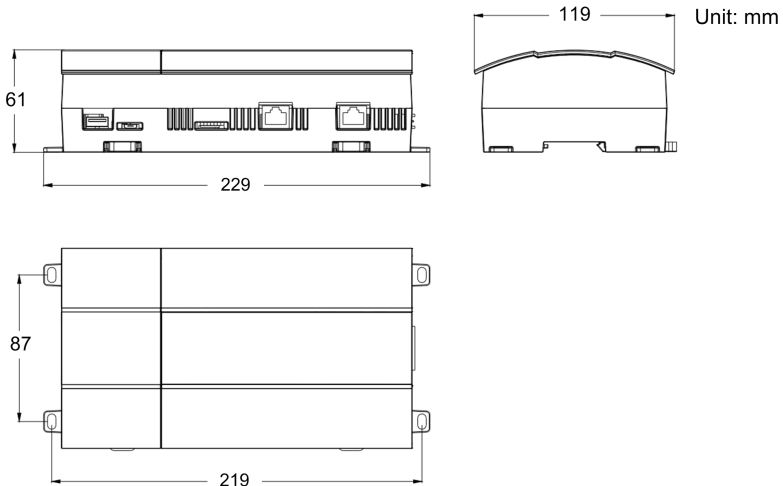

Fig. 7.1 Gateway product size chart

Notice for installation and operation:

- (1) Ensure the specification of power input. Otherwise, Gateway can't work normally or even be damaged.
- (2) Ensure the dial code setting of Gateway is correct. Otherwise, there will be communication malfunction.

- (3) Ensure that the communication cord has connected to the correct interface. Otherwise, there will be communication malfunction.
- (4) Do not place Gateway in direct sunlight or high-temperature and humid environment. Place it in the central control cabinet.

7.1.2 Spatial Size for Electric Control Cabinet Installation

Gateway shall be installed in electric control cabinet; the front of gateway shall be hung upward and fixed with 4 screws. See the following fig (for reference).

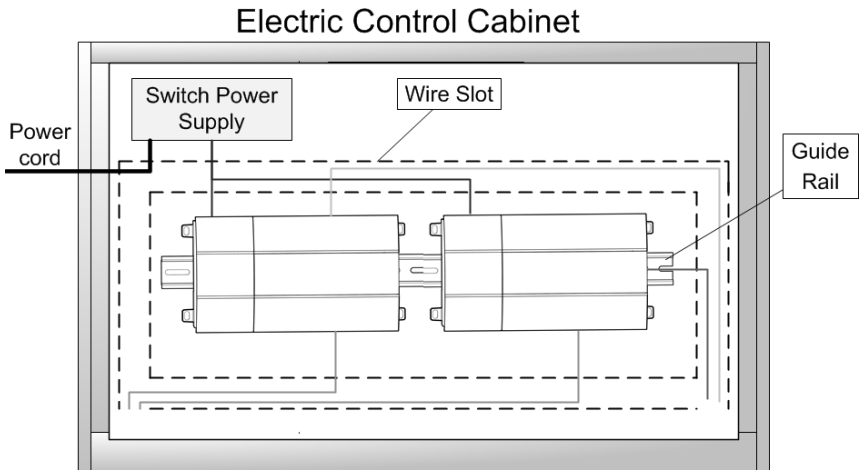

Fig. 7.2 Gateway installation guide

⚠ WARNING! Power cord and communication line of Gateway must conduct routing separately (the distance shall be over 15cm); otherwise, it might lead to Gateway communication malfunction!

The thin real line shown in the figure is communication wire and weak current wire, the thick real line is strong current wire. Above lines are only for reference.

7.2 Gateway and BMS adopt Modbus RTU Protocol Communication Connecting Method

7.2.1 Material Selection for Communication line

Communication system	Type of material	Length L (m)	Cable diameter (mm ²)	Material Standard	Remarks
Communication between gateway and BMS via Modbus	Shielding light/general PVC jacket twisted pair	L≤800	≥2×0.75	IEC 60227-5:2007	When the communication distance exceeds 800m, a PV isolation relay should be added.

7.2.2 Communication Connection Method

NOTICE! All communication connection lines under Gateway must be in series connection, star connection shall not be adopted.

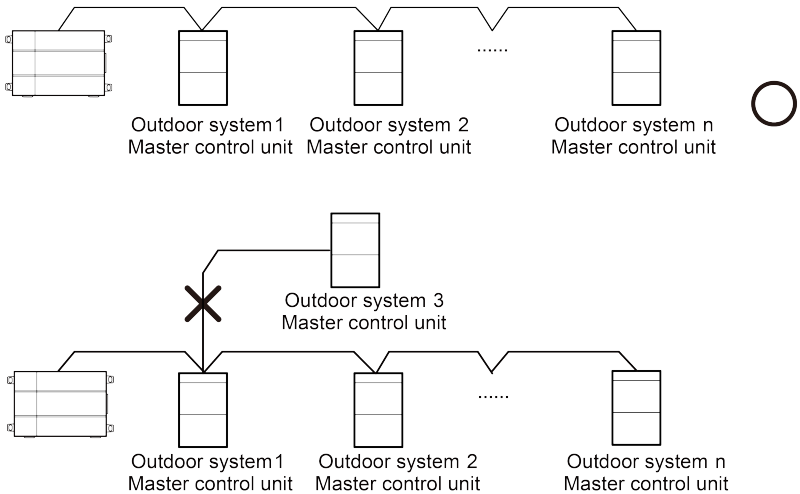

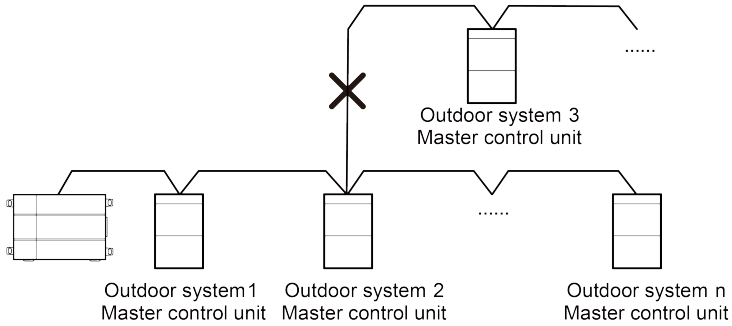

Fig. 7.3 Schematic of connecting method of gateway

! NOTICE! In the Modbus, when the quantity of connected gateway exceeds 30 or the communication distance exceeds 800m, one more PV isolation relay should be added, and connect the R+ and R- terminals of PV isolation relay to the RS485-1 communication interfaces R+ and R- of the adjacent gateway.

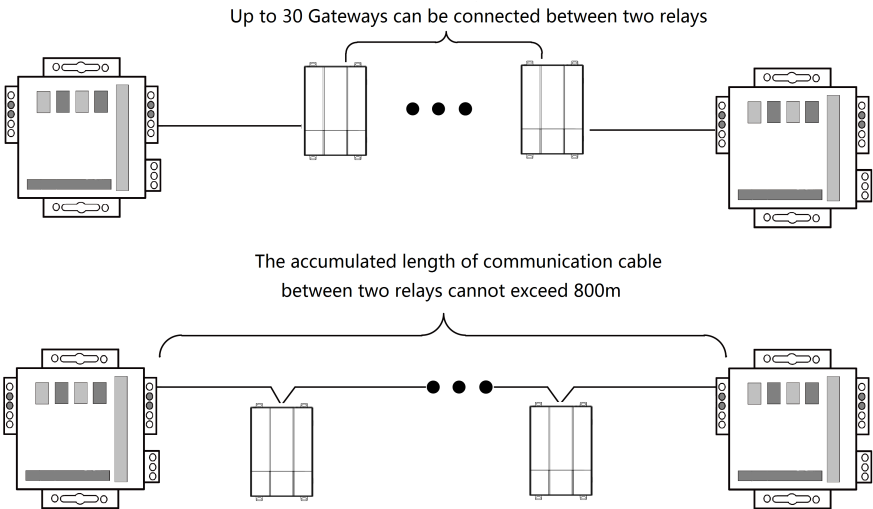

Fig. 7.4 Installation of relay

7.2.3 Setting of communication connection

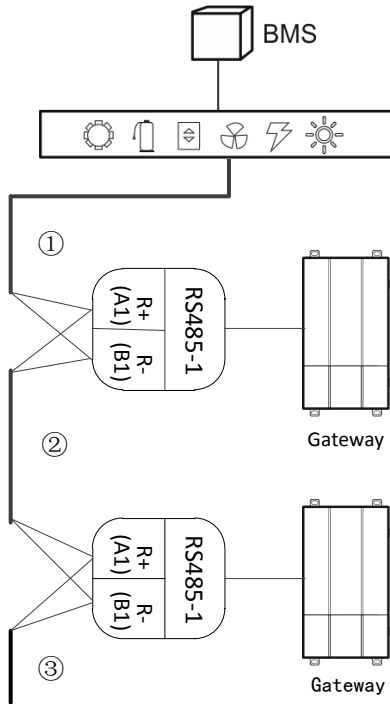

Fig. 7.5 Connection between gateway and BMS via Modbus

Step 1: Ensure the first gateway that should connect to BMS terminal, connect the RS485-1 communication interfaces R+ and R- of the gateway to the BMS terminal with communication cable; as shown in Step ① in the figure.

Step 2: Connect the RS485-1 communication interfaces R+ and R- of the gateway to the RS485-1 communication interfaces R+ and R- of the second gateway with communication cable; as shown in Step ② in the figure.

Step 3: Connect other gateways in turn; as shown in Step ③ in the figure.

7.3 Gateway and BMS adopt Modbus RTU Protocol Communication Connecting Method

7.3.1 Material Selection for Communication line

- (1) Model selection of Gateway and BMS communication line shall use standard Ethernet communication line, the length of network cable between gateway and router (computer, switchboard, etc.) shall not exceed 80m

(2) Communication line model selection for Gateway and AC unit

Wire type	L(m)Communication line between gateway and AC units	Wire diameter(mm ²)	Wire standard	Remark
Light-weight/normal PVC jacket twisted copper wire	L ≤ 500	≥ 2×0.75	IEC 60227-5:2007	Total communication length shall not exceed 500m

7.3.2 Communication Connection Method

(1) Communication connection between Gateway and BMS

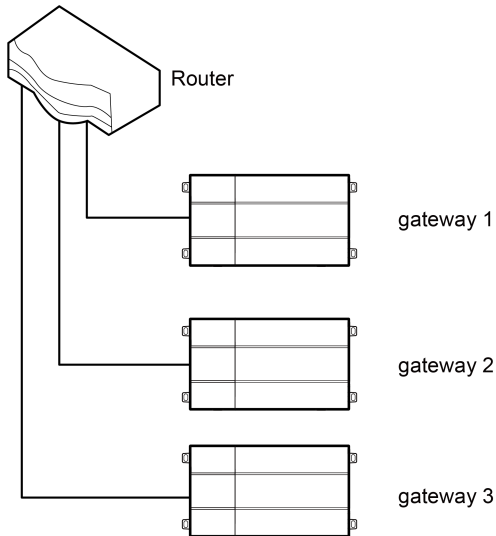

Fig. 7.6 Connecting method between gateway and router

VRF Protocol Gateway

(2) Communication connection between Gateway and AC units (n is the quantity of ODU system, $n \leq 16$)

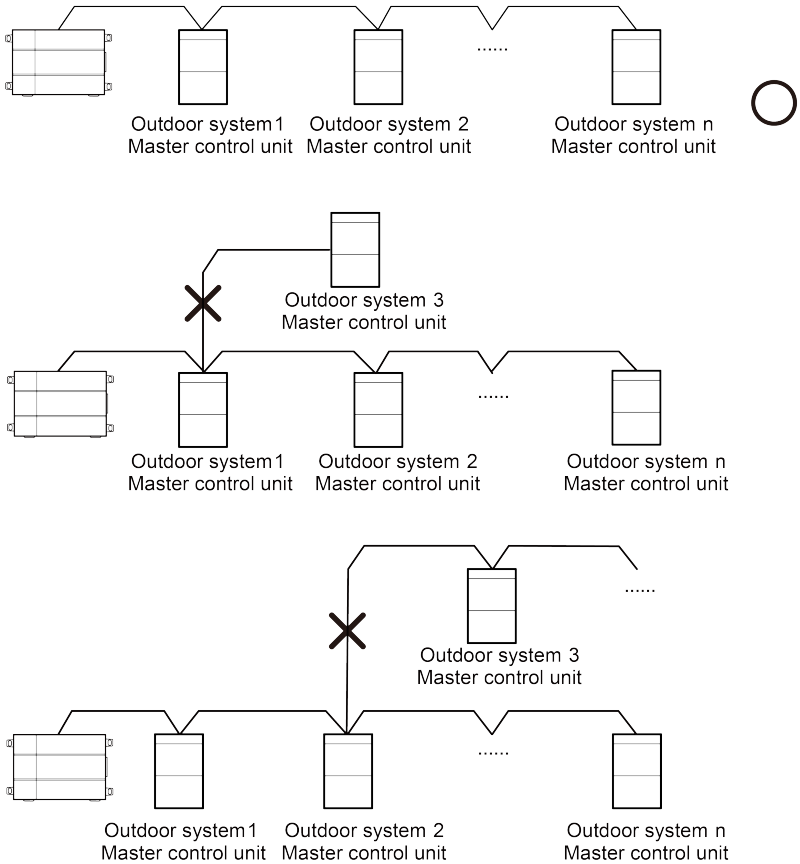

Fig. 7.7 Connecting method of gateway

! NOTICE! All communication connection lines under Gateway must be in series connection, star connection shall not be adopted.

7.3.3 Communication Connection Configuration

(1) Communication line connection between Gateway and PC:

Connection diagram between Gateway and PC user side:

- 1) Adopt cross connection network cable, Gateway shall directly connect to PC.

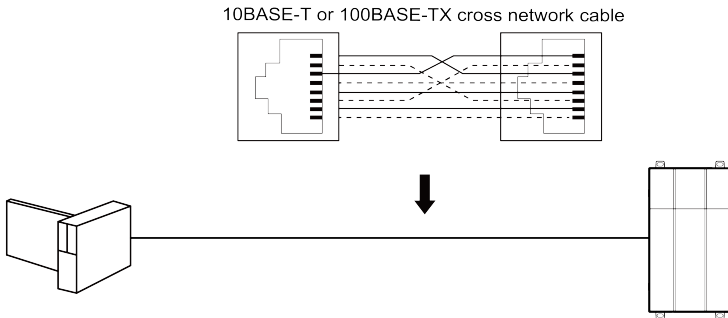

Fig. 7.8 Gateway connects to personal computer directly

- 2) Adopt parallel network cable, Gateway shall go through router to connect to PC.

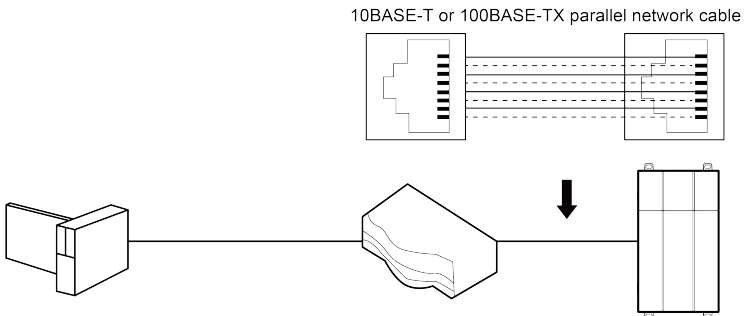

Fig. 7.9 Gateway connects to personal computer via router

- (2) Communication line connection between Gateway and AC units:

When gateway is connected to main control unit of ODU, ODU with the address dial-up of 0 must be connected.

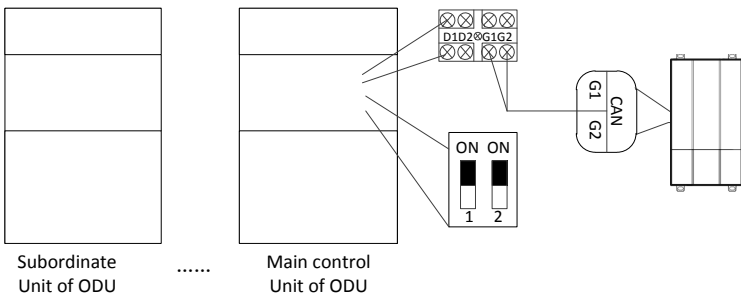

Fig. 7.10 Communication connection between gateway and unit

(3) Gateway configuration:

One gateway connects to 16 sets of systems and 255 sets of indoor units simultaneously. After installation, the parameters of gateway should be set. Before setting the parameters of gateway, please set the IP address of PC as the same with the IP address in the same network segment of gateway, as refer to appendix A; and then open the browser (IE10 and above version, Firefox or Google), input the default IP address of gateway: <http://192.168.1.150>, default user name: config, password: config; as shown below.

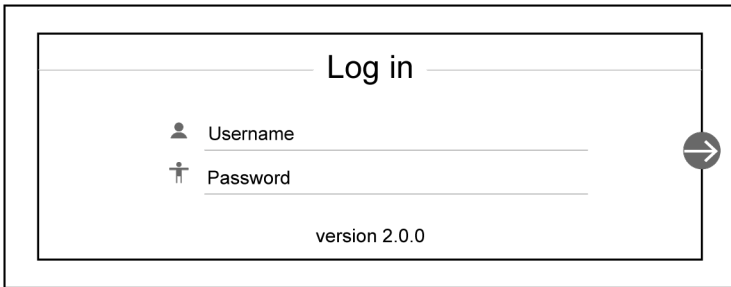

Fig. 7.11 Log on interface

Setting of gateway protocol functions:

After inputting user name and password, click the arrow to enter the setting interface, as shown in Fig. 7.12, 7.13, and 7.14; in the setting interface 1, you can select the protocol function; in the setting interface 2, you can set the IP parameters of gateway; in the setting interface 3, you can set the equipment information.

Note: When the gateway is energized, it will conduct default Modbus protocol function, when select to reset the gateway and log on the gateway setting interface again, the protocol option of interface 1 is blank, you can select according to demand.

Setup

Protocol DeviceIP Device information

Connect to the device protocol of the access gateway

BACnet
 Modbus

Computer time:2020-06-29 16:59:44

Version 2.0.0

Fig. 7.12 Selection of protocol function

Setup

Protocol DeviceIP Device information

Configure IP address,netmask,and default gateway of the gateway device.

IP address : 192 .168 .1 .150

Netmask: 255 .255 .255 .0

Gateway: 192 .168 .1 .1

Version 2.0.0

Fig. 7.13 Setting interface of network parameters

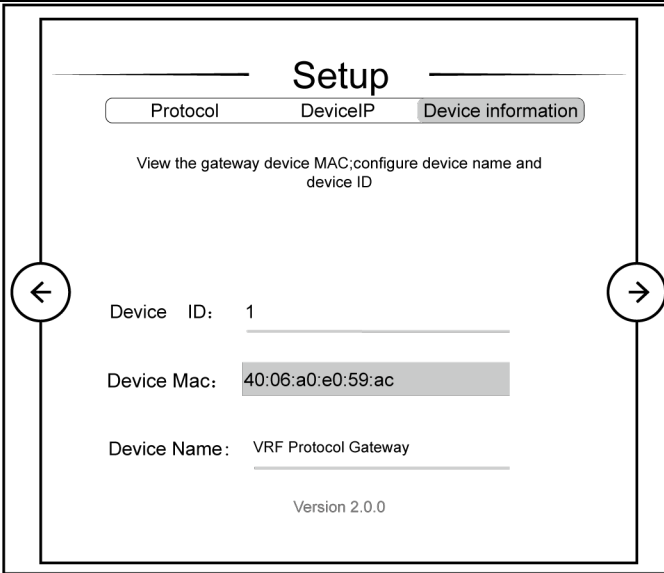

Fig. 7.14 Setting interface of equipment information

The settable parameters: IP address of gateway (in which setting of IP address: master unit number should not be 0, all 0 refers to the whole network, such as 192.168.1.0; master unit number should not be all 1, all 1 refers to broadcast address, such as 192.168.1.255; it is not recommended to set the address by user, otherwise it may cause problems such as the network is not accessible), subnet mask of gateway, default gateway, gateway name, gateway ID. User can set by himself/herself according to the actual needs. After setting, click the arrow, the interface will pop up a window to ask: Whether to restart the gateway to make the setting come into effect? Click yes and then the gateway is restarted.

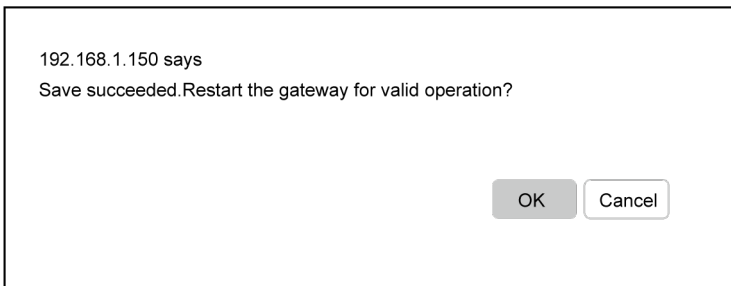

Fig. 7.15 Restart the pop-up window

8 BACnet Protocol

8.1 Structure of BACnet Protocol

The structure of BACnet standard protocol is specific to building self-control system characteristics, a simplified 4-layer structure from OSI 7-layer structure; this 4-layer is corresponding to the application layer, network layer, data link and physical layer in OSI model. BACnet standard protocol defines its application layer and network layer, and provides the following 5 solutions to its data link and physical layers.

BACnet Layers					Equivalent OSI Layers
BACnet Application Layer					Application
BACnet Network Layer					Network
ISO8802-2 (IEEE802.2) Type1		MS/TP	PTP	LonTalk	Data Link
ISO8802-3 (IEEE802.3)	ARCNET	EIA-485 (RS485)	EIA-232 (RS232)		Physical

8.2 Object and Property of BACnet Protocol

8.2.1 Definition of BACnet Object

BACnet defines a group of objects with property to represent any functions of building self-control equipment, thus provide a standard method to represent building self-control equipment. The Gateway defines 9 objects, the enumeration number, name and application sample of these objects are introduced as follows.

No.	Object name	Application sample
0	Analog Input	Sensor input
1	Analog Output	Control output
2	Analog Value	The set valve value or other analog control system parameter
3	Binary Input	Switch input
4	Binary Output	Relay output
5	Binary Value	Digital control system parameter
13	Multi-state Input	Indicate a multi-state processing program situation, such as open/close refrigerator and defrosting cycle etc.
14	Multi-state Output	Indicate a multi-state processing program expectation status, e.g. started cooling time for refrigerator.
19	Multi-state Value	Indicate a multi-state processing program parameter, such as AC fan speed setting and mode setting, etc.

Each object has a set of property, the property value describes the features and functions of the objects.

8.2.2 Table of BACnet Protocol Point

One BACnet object ID is consist of the following 5 parts:

BACnet object ID (32bits)				
10 bits	3 bits	2 bits	9 bits	8 bits
Reserved	Model series (assigned to be 0)(M)	Equipment type(01,02,03)(D)	Equipment migration(N)	Parameter No.(P)

Equipment type: include the gateway itself (0), IDU (1), ODU (2) and IO module (3).

Equipment migration: for IDU object, it means the IDU No.;

Parameter number: the sequence of parameter number after data conversion;

ID value of BACnet object:

$$\text{BACnet ID} = P + N * 256 + D * 256 * 512 + M * 256 * 512 * 4;$$

For example indoor ambient temperature of object

(IndoorUnitAmbientTemp_01_01_01) , its BACnet object ID is

(IndoorUnitAmbientTemp_01_01_01) with the following meaning:

BACnet object ID(32bits)				
10 bits	3 bits	2 bits	9 bits	8 bits
Reserved	Model series (assigned to be 0)(M)	Equipment type(01,02,03)(D)	Equipment migration(N)	Parameter No.(P)
0	0: Multi VRF	1:IDU	1	1

If the value of initial IDU engineering code object

(FirstIndoorUnitNum_01_00_00 with object ID of 1) of this Gateway is M, then

IndoorUnitAmbientTemp_01_01_01 (131329) represents a IDU parameter with the engineering code of (M+1).

9 Attachment A TCP/IP Setting

This text takes Windows 10 as example to demonstrate the setting of TCP/IP.

- (1) Left click the icon “Start”  on the computer. When a new window pops up, left click “Settings” to enter “Windows Settings”.
- (2) Left click “Network & Internet” in the following picture to enter the interface of “Network & Internet”. See ① in the picture below.

Windows Settings

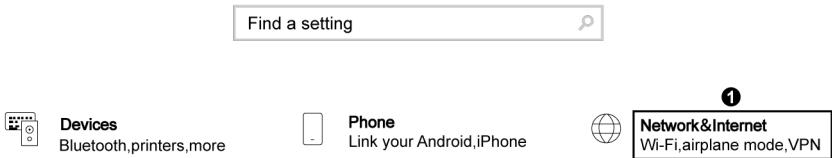

Fig 9.1 Windows settings

(3) Left click "Network and Sharing Center" in the following picture. See ② in the picture below.

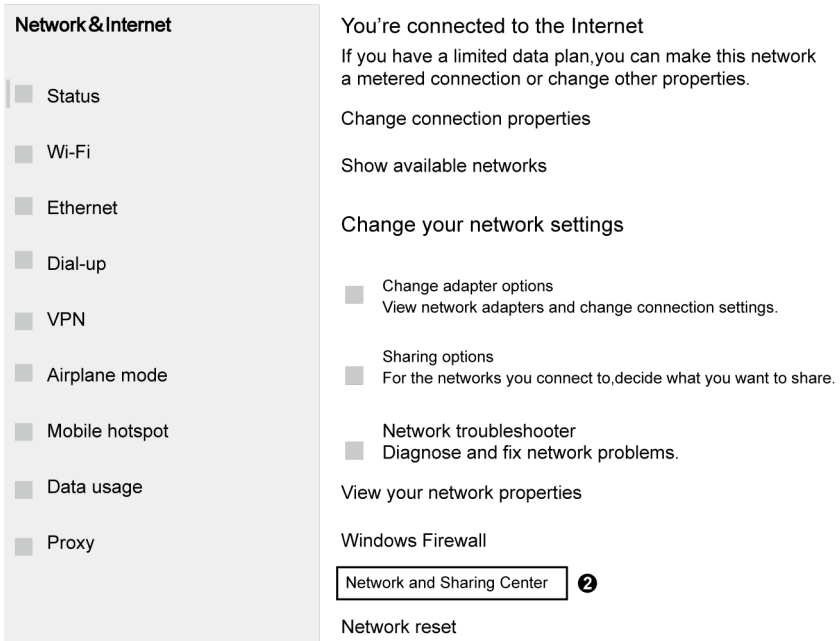

Fig 9.2 Network and Sharing Center

(4) Find "Ethernet" in the following picture. Left click "Ethernet" and enter the interface of "Ethernet Status". See ③ in the picture below.

View your basic network information and set up connections

View your active networks

TP-WIFI-004
Public network

Access type: Internet
Connections: **Ethernet** ③

Fig 9.3 Ethernet settings selection

- (5) Left click “Properties” in the following picture and enter the interface of “Ethernet Properties”. See ④ in the picture below.

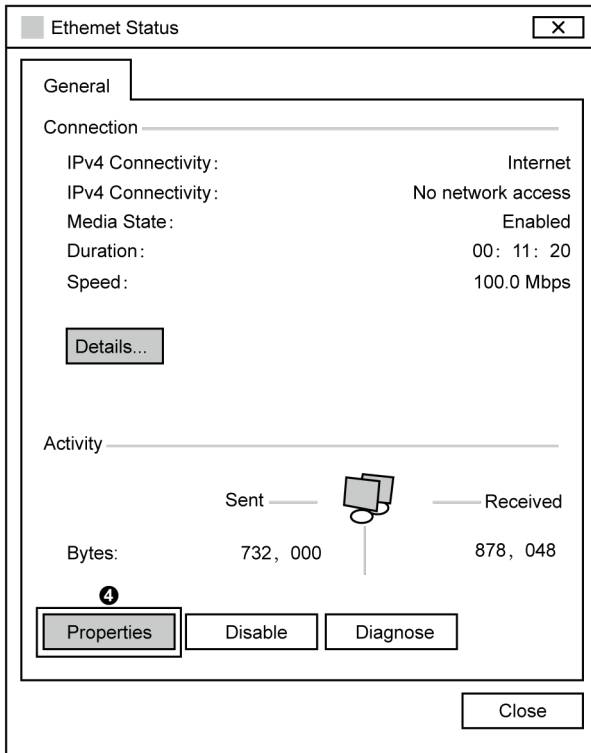

Fig 9.4 Ethernet attribute selection

(6) Left click “Internet Protocol Version 4(TCP/IPv4)”. See ⑤ in the picture below. Then left click “Properties” as shown in the picture to enter the interface of “Properties of Internet Protocol 4(TCP/IPv4)”. See ⑥ in the picture below.

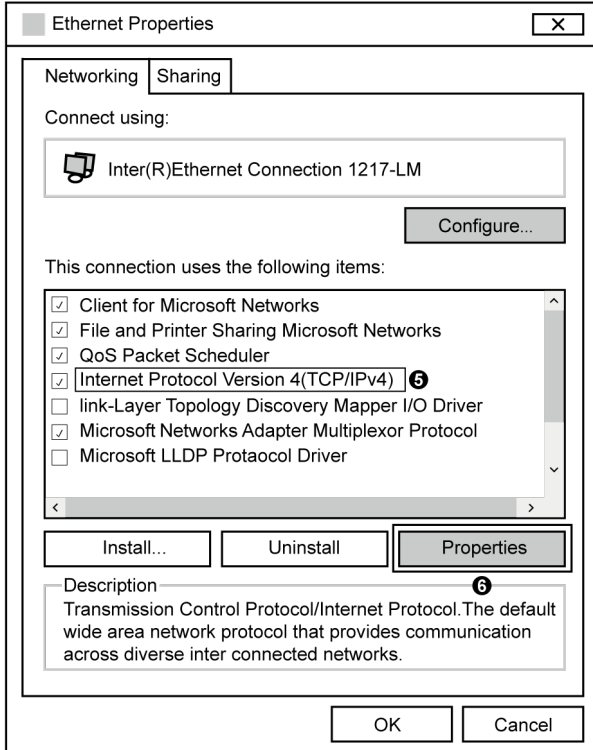

Fig 9.5 Internet Protocol Version 4 (TCP/IPv4) Properties

- (7) When you are at the interface of “Properties of Internet Protocol Version 4(TCP/IPv4)” as shown below, change the IP address, subnet mask, default gateway as required (address of network equipment for connecting Gateway must be the same as the network address of Gateway ME30-24/D1(BM)). Generally, DNS remains unchanged.

Internet Protocol Version 4(tcp/IPv4)Properties

General

You can get IP settings assigned automatically if your network supports this capability. Otherwise, you need to ask your network administrator for the appropriate IP settings.

Obtain an IP address automatically

Use the following IP address:

IP address: 192 . 168 . 1 . 207

Subnet mask: 255 . 255 . 255 . 0

Default gateway: 192 . 168 . 1 . 1

Obtain DNS server address automatically

Use the following DNS server addresses:

Preferred DNS server: 10 . 1 . 2 . 223

Alternate DNS server: 10 . 1 . 2 . 224

Validate settings upon exit

Advanced...

OK Cancel

Fig 9.6 Ethernet IP parameter settings

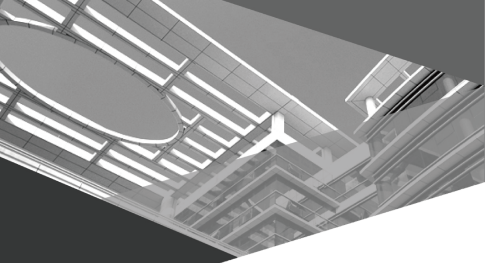

GREE ELECTRIC APPLIANCES, INC. OF ZHUHAI

Add: West Jinji Rd, Qianshan, Zhuhai, Guangdong, China, 519070

Tel: (+86-756) 8522218

Fax: (+86-756) 8669426

E-mail: global@cn.gree.com www.gree.com



600005062891