



Owner's Manual

Original Instructions
Commercial Air Conditioners

Centralized Controller

Model:

CE52-24/F(C)

Thank you for choosing commercial air conditioners.
Please read this Owner's Manual carefully before operation
and retain it for future reference.

If you have lost the Owner's Manual, please contact the
local agent or visit www.gree.com or send an email to
global@cn.gree.com for the electronic version.

GREE ELECTRIC APPLIANCES, INC.OF ZHUHAI

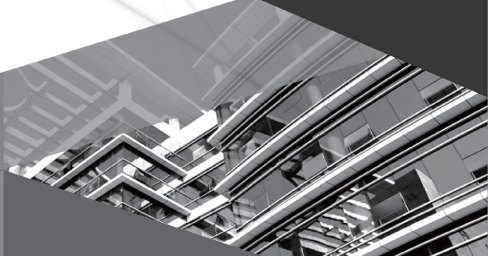

To Users

Thank you for selecting Gree product. Please read this instruction manual carefully before installing and using the product, so as to master and correctly use the product. In order to guide you to correctly install and use our product and achieve expected operating effect, we hereby instruct as below:

- (1) This appliance is not intended for use by persons (including children) with reduced physical, sensory or mental capabilities, or lack of experience and knowledge, unless they have been given supervision or instruction concerning use of the appliance by a person responsible for their safety. Children should be supervised to ensure that they do not play with the appliance.
- (2) This instruction manual is a universal manual, some functions are only applicable to particular product. All the illustrations and information in the instruction manual are only for reference, and control interface should be subject to actual operation.
- (3) All the illustrations and information in the instruction manual are only for reference. In order to make the product better, we will continuously conduct improvement and innovation. If there is adjustment in the product, please subject to actual product.
- (4) If the product needs to be installed, moved or maintained, please contact our designated dealer or local service center for professional support. Users should not disassemble or maintain the unit by themselves, otherwise it may cause relative damage, and our company will bear no responsibilities.

Contents

| | |
|---------------------------------------------------------|-----------|
| 1 Safety Notices (Please be sure to abide) | 1 |
| 2 User Notice | 1 |
| 3 Installation | 2 |
| 3.1 Installation Requirements | 3 |
| 3.2 Wiring Instructions | 5 |
| 3.3 Installation Procedure | 14 |
| 3.4 Removal Procedure | 16 |
| 4 Display and Working Instructions | 16 |
| 4.1 Main Page Display and Buttons..... | 17 |
| 4.2 General Buttons | 18 |
| 4.3 Buttons Working Instructions | 19 |
| 5 Functions Description | 21 |
| 5.1 Help Info..... | 21 |
| 5.2 VRF Unit | 21 |
| 5.3 Single Unit Control | 22 |
| 5.4 Water/Floor Control | 25 |
| 5.5 Fresh Air Control | 30 |
| 5.6 All-Control Function..... | 32 |
| 5.7 Group Control | 34 |
| 5.8 Schedule Management | 35 |
| 5.9 L-CAC&Split Unit | 38 |
| 5.10 Local Setting | 42 |
| 5.11 Engineering Setting..... | 44 |
| 5.12 About..... | 46 |

1 Safety Notices (Please be sure to abide)



WARNING: If not abide them strictly, it may cause severe damage to the unit or the people.



NOTE: If not abide them strictly, it may cause slight or medium damage to the unit or the people.



This sign indicates that the items must be prohibited. Improper operation may cause severe damage or death to people.



This sign indicates that the items must be observed. Improper operation may cause damage to people or property.



WARNING!

This product can't be installed at corrosive, inflammable or explosive environment or the place with special requirements, such as kitchen. Otherwise, it will affect the normal operation or shorten the service life of the unit, or even cause fire hazard or serious injury. As for the above special places, please adopt special air conditioner with anti-corrosive or anti-explosion function.

2 User Notice

- ◆ All indoor units must be supplied with unified power.
- ◆ Make sure communication cord is connected with the proper port, otherwise there may occur communication malfunction.
- ◆ Never knock on, throw or frequently detach the centralized controller.
- ◆ Never operate the centralized controller with wet hands.
- ◆ Never scratch the screen of centralized controller by hard or sharp objects.
- ◆ If the centralized controller is connected with the outdoor network or the last indoor unit of the indoor network, then a matching resistance must be connected between G1 and G2 ports.
- ◆ the centralized controller Connect with L-CAC&Split unit, The indoor unit address must be set within the range from 1 to 36, communication way of L-CAC&Split unit set long distance monitoring mode.

3 Installation

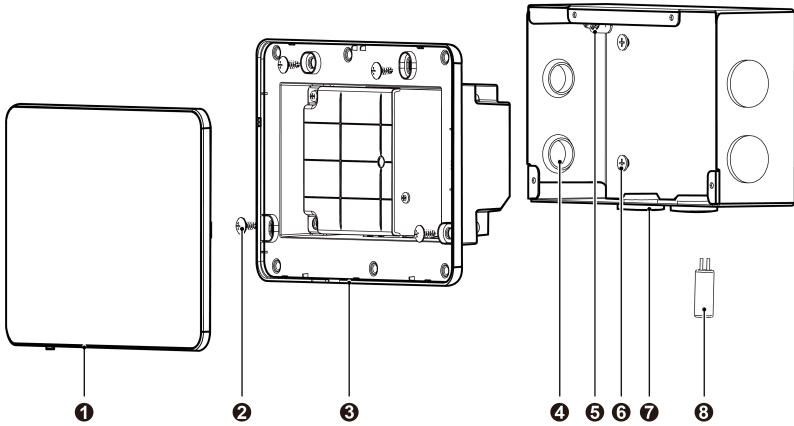

Fig.3.1 Parts of Centralized Controller

| | | | | |
|------|--------------------------------------------|------------------------------------------------------------------------------|--------------------------|---------------------|
| No. | ① | ② | ③ | ④ |
| Name | Touch screen | Self-tapping screw ST4.2×9.5 MC(used to secure the rear cover of controller) | Rear cover of controller | Rubber band |
| QTY | 1 | 4 | 1 | 6 |
| No. | ⑤ | ⑥ | ⑦ | ⑧ |
| Name | Screw M4×12 (used to secure earthing wire) | Screw ST4.2×16 FA (used to secure electric box cover) | Electric box cover | Matching resistance |
| QTY | 1 | 4 | 1 | 2 |

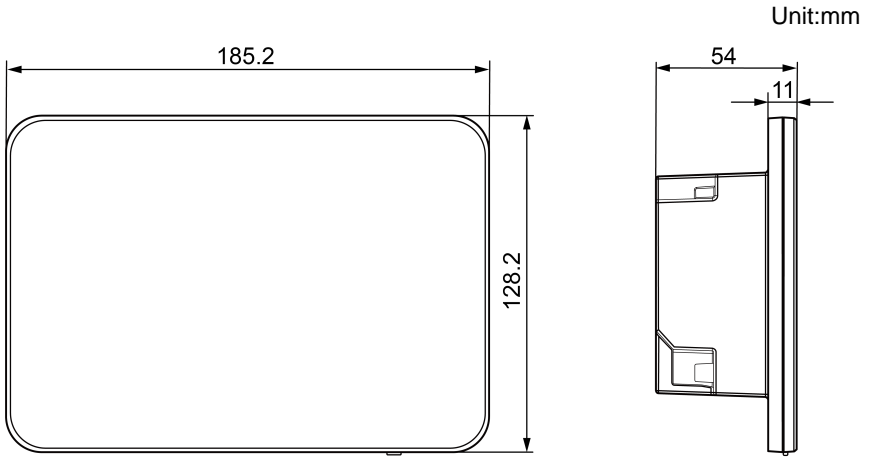

Fig.3.2 Dimension of Centralized Controller

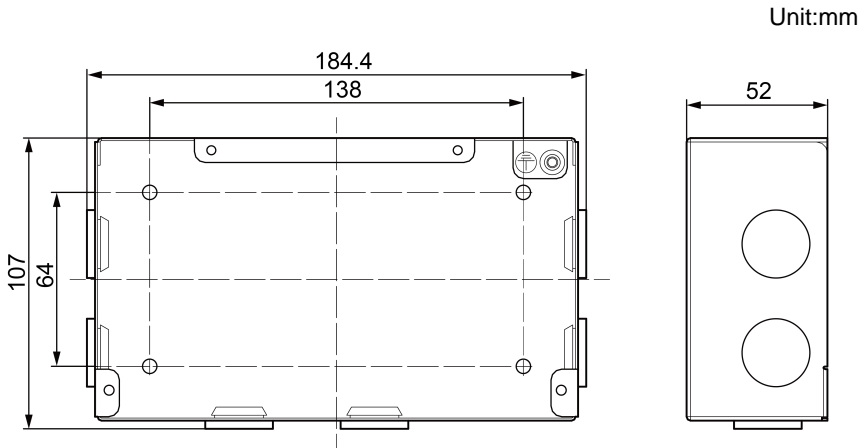

Fig.3.3 Dimension of Electric Box Cover

3.1 Installation Requirements

- (1) Communication cord of the centralized controller and Multi-VRF (CAN Network) must be selected according to the table below. Never use the cable that is not in compliance with instructions of this manual.

| Network | Cord type | Cord standard | Cord size (mm ² /AWG) | Total length L(m/feet) | Remark |
|-----------------|--------------------------------------------------------------------------------|------------------|----------------------------------|---------------------------|--------------------------------------------------------------------------------------------------------------------------------------------------|
| Indoor network | Light/ Ordinary polyvinyl chloride sheathed cord. (60227 IEC 52 /60227 IEC 53) | IEC 60227-5:2007 | 2×0.75~2×1.25 (2×AWG18~2×AWG16) | L≤1000m (L≤3280-5/6 feet) | If cord size is 2×1mm ² (2×AWG16), communication cord can be stretched longer. But the total length can't exceed 1500m(4921-1/4feet). |
| Outdoor network | | | | L≤500 (L≤820-1/5feet) | Total length of communication cord can't exceed 500m(820-1/5feet). |



NOTICE:

- ① The cord shall be Circular cord (the cores shall be twisted together).
 - ② If unit is installed in places with intense magnetic field or strong interference, it is necessary to use shielded wire.
- (2) Communication cord of the centralized controller and L-CAC&Split Unit (Modbus net) must be selected according to the table below.

| Cord type | Cord size (mm ²) | Cord standard | Note |
|----------------------------|------------------------------|---------------|--------------------------------------------------------------------------------------------------------|
| Two_core five twisted pair | 24AWG(2×0.6mm) | TIA/EIA-568-A | When the communication distance exceeds 800m, the need to increase the photoelectric isolation repeter |

- (3) Never install the centralized controller in the following places:
- 1) Places with corrosive gas or serious dust, salt mist or oil smoke.
 - 2) Wet and damp places, with direct sunlight.
 - 3) Places near high temperature objects or places where units might be splashed by water.

3.2 Wiring Instructions

3.2.1 Wiring Ports

| Port print | G1, G2 | F1, F2 | A2, B2 | A3, B3 | L, N |
|------------|----------------|-----------------|-------------------|-----------------------|------------|
| Meaning | CAN comm. port | fire alarm port | 【 reserved port 】 | L-CAC&Split unit port | Power port |

3.2.2 Power Supply

The centralized controller shall use independent power supply.

The range of input voltage: 100~240 VAC; Frequency range: 50/60Hz

Select power cord according to the following table. Never use the power cord that is not in compliance with instructions of this manual.

| Cord type | Cord standard | Cord size (mm ²) |
|-----------------------------------------------------------|------------------|------------------------------|
| Single-cord soft conductiveunsheathed cord (60227 IEC 08) | IEC 60227-3:2007 | 1.5 |

3.2.3 Connection Method of Multi-VRF (CAN Network)

There are three methods to connect centralized controller with the Multi-VRF system.

Method 1: Connect with indoor network

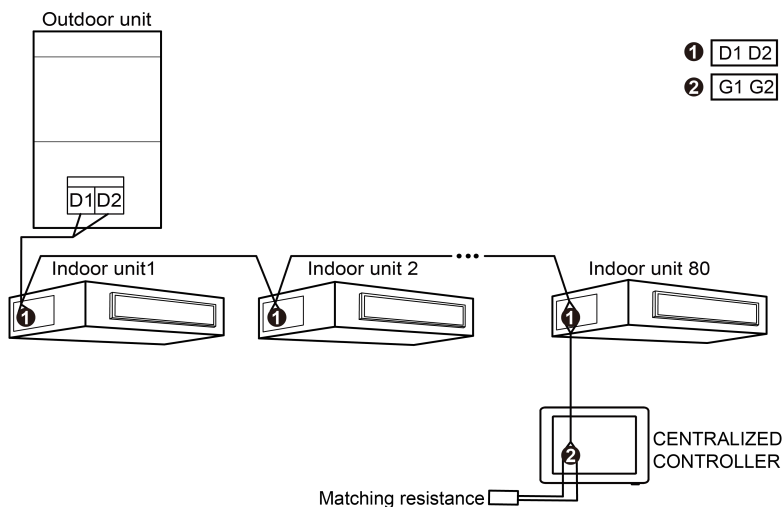

Fig.3.4 Centralized Controller Connected with Indoor Network

Method 2: Connect with outdoor network

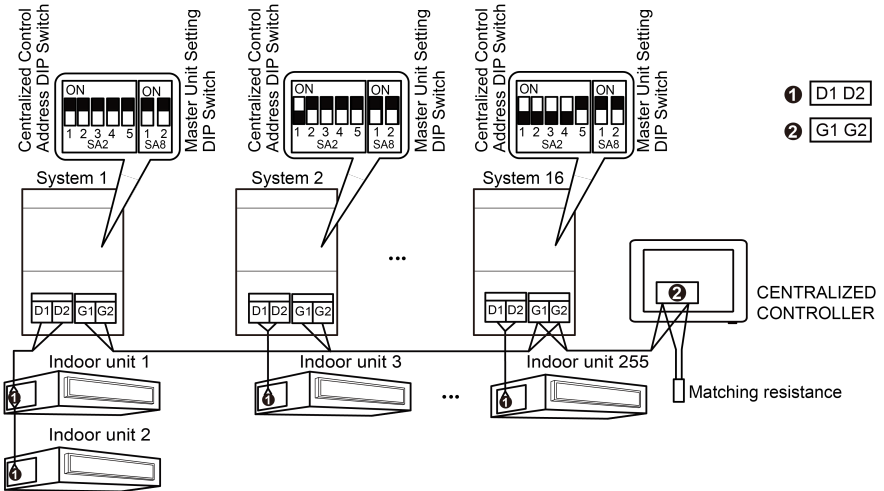

Fig.3.5 Centralized Controller Connected with Outdoor Network

Method 3: Connect with heat recollection mode converter Network

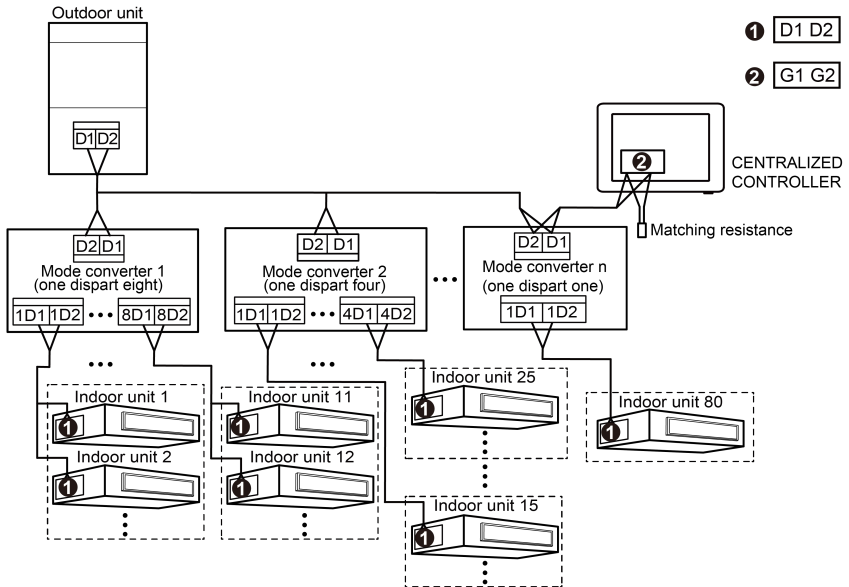

Fig. 3.6 Centralized Controller Connected with Heat Recollection Mode Converter Network

Wiring Instructions:

- (1) The centralized controller is applicable to multi VRF units, connectable with network of indoor units or the network of outdoor units. One centralized controller can control up to 16 sets of outdoor system and up to 255 sets of indoor unit.
- (2) If the centralized controller is to be connected with the network of indoor units, connect according to fig.3.4. The centralized controller can only be connected with the terminal unit of indoor network. A matching resistance needs to be added with the communication cords at the G1 and G2 ports.
- (3) If the centralized controller is to be connected with the network of outdoor units, connect according to fig.3.5. The centralized controller can only be connected with the terminal system of the outdoor network. A matching resistance needs to be added with the communication cords at the G1 and G2 ports.
- (4) The centralized control address DIP switch (SA2_Addr-CC) indicates the centralized control address required when different refrigerating systems are controlled in a centralized manner. The default factory setting is "00000".
- (5) If the centralized controller is to be connected with the network of heat recollection, connect according to Fig.3.6. The method 2 is also applicable to centralized controller switching in heat recollection network.

If the centralized controller is to be connected with the network of outdoor units, set the DIP switch according to the following methods:

- 1) The DIP switch must be set on the master unit and set the Master Unit Setting DIP Switch(SA8) to "00". Otherwise, the setting is invalid.
- 2) On the same refrigerating system, the centralized control address DIP switch (SA2_Addr-CC) on a non-master unit is invalid, and it is unnecessary to change the settings.
- 3) The centralized control address DIP switch (SA2_Addr- CC) on the master unit of a refrigerating system must be set to "0000/", and this system is the master system.
- 4) The centralized control address DIP switch (SA2_Addr- CC) on the master unit of other refrigerating systems must be set as follows:

| SA2 | | | | | Address NO. |
|------|------|------|------|------|-------------|
| DIP1 | DIP2 | DIP3 | DIP4 | DIP5 | |
| 1 | 0 | 0 | 0 | / | 2 |
| 0 | 1 | 0 | 0 | / | 3 |
| 1 | 1 | 0 | 0 | / | 4 |
| 0 | 0 | 1 | 0 | / | 5 |
| 1 | 0 | 1 | 0 | / | 6 |
| 0 | 1 | 1 | 0 | / | 7 |
| 1 | 1 | 1 | 0 | / | 8 |
| 0 | 0 | 0 | 1 | / | 9 |
| 1 | 0 | 0 | 1 | / | 10 |
| 0 | 1 | 0 | 1 | / | 11 |
| 1 | 1 | 0 | 1 | / | 12 |
| 0 | 0 | 1 | 1 | / | 13 |
| 1 | 0 | 1 | 1 | / | 14 |
| 0 | 1 | 1 | 1 | / | 15 |
| 1 | 1 | 1 | 1 | / | 16 |

5) The centralized control address DIP switch (SA2_Addr-CC) cannot be the same between different refrigerating systems. Otherwise, address conflicts may occur and the unit cannot run properly.

NOTES:

- ① Centralized control address SA DIP5 invalid.
- ② If the centralized control address DIP switch (SA2_Addr-CC) on the master unit of one of VRF system is set to “1111X”, The system is the master mode system, the indoor units of other systems can not set the mode of conflicting with the master mode system.

For example: When master mode system is set to cooling mode, the indoor unit of other systems can not set heating mode.

6) If the address conflict occurs, it will pop up the address conflict page.

NOTES:

There are three ways to solve address conflict.

- ① Enter into an unoccupied address by manually for the conflict address, the address conflict can be solved after it set up success.

- ② Press and hold the “Save” button for 5 seconds on the address conflict page, select reset all the IDU’s address in the system, after entering the engineering password, system will reassign all the address.
- ③ On the master unit of master system, if the mainboard has 7 buttons,press “SW3” to enter the to-be-selected status of function settings, press “SW1 (UP) ” or “SW2 (DOWN) ” to select the function of “n5”, press “SW7” to enter “n5” function settings, press “SW7” again to send the project number offset command. If the mainboard has 4 buttons, press and hold “SW1” for 5 seconds to enter the to-be-selected status of function settings, press “SW1 (UP)” or “SW2 (DOWN) ” to select the function of “n5”, press “SW3” to enter “n5” function settings, press “SW3” again to send the project number offset command.

3.2.4 Connection Method of L-CAC&Split Unit (Modbus network)

The central controller has two ways to connect with the unitary system:

Method 1: the centralized controller Connect with U-match Unit (Modbus network) according to the below

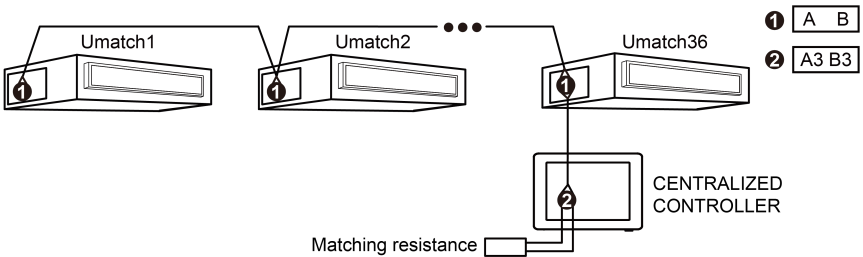

Fig. 3.7 Centralized Controller Connected with U-match Unit

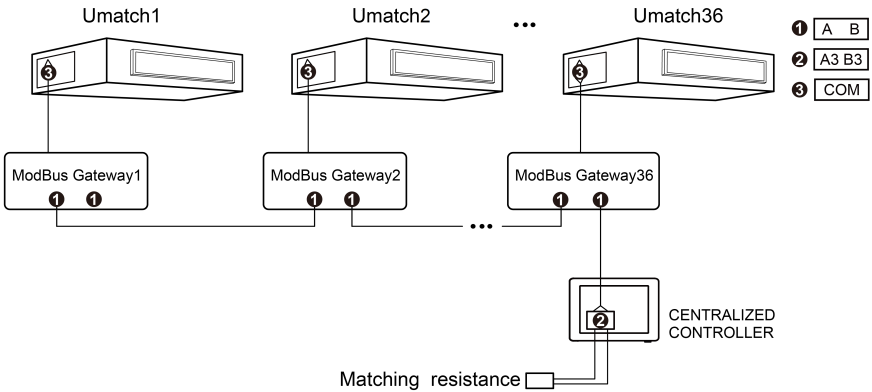

Fig. 3.8 Centralized Controller Connected with U-match Unit

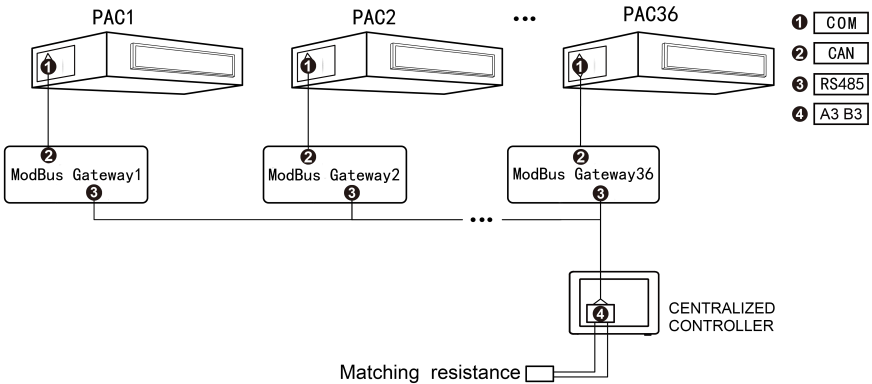

Fig.3.9 Centralized Controller Connected with PAC Unit

Wiring Instructions:

- (1) The centralized controller is applicable to U-match units (Including PAC units), One centralized controller can control up to 36 U-match units.
- (2) If the centralized controller is to be connected with U-match units which have COM_BMS ports, connect according to fig.3.7. The controller must connect with terminal unit of U-match system. Connect the centralized controller's A3 and B3 ports to COM_BMS port on the U-match unit correspondingly with communication cords. A matching resistance needs to be added with the communication cords at the A3 and B3 ports. There are two COM_BMS ports (two core neilsbed and no polarity) on mainboard of U-match unit, one for centralized controller and another for U-match unit connection.

NOTE:

If the centralized controller is to be connected with U-match units, communication line(one end is two-core terminal, the other end is the bare wire. Code: 420400060252)need to be purchased separately. The quantity of communication line is the quantity of U-match units plus 1.

- (3) If the centralized controller is to be connected with U-match units which have 6-core neilsbed, connect according to fig.3.8. The controller must connect with terminal gateway. Connect the centralized controller's A3 and B3 ports to A and B port on the Modbus Gateway. A matching resistance needs to be added with the communication cords at the A3 and B3 ports. The modbus gateway connecte to 6-core neilsbed of U-match mainboard, need to be purchased separately. Each U-match unit need one Modbus gateway.
- (4) The indoor unit address must be set within the range from 1 to 36, and different from each other. Identicle addresses will lead to communication failure. Below is the address setting method:
 - 1) Under OFF status, press "Function" and "Mode" on the wired controller simultaneously for 5S to enter the address setting. Then the display panel will show its own address number on the temperature display zone. Adjust the number by pressing the "Up" and "Down" buttons.
 - 2) When setting is over, press "OK/Cancel" or "Swing/Enter" to save the setting and exit. Under the setting status, if no action is taken within 20S, system will exit from the setting and return to the display mode of OFF status. Setting can't be saved in this case.
- (5) Communication method of U-match units must be long-distance monitoring mode, else can not communicate with centralized controller, set the way as follows.
 - 1) Under OFF status, press "Function" and "Timer" on the wired controller simultaneously for 5S to enter the setting of long-distance monitor. Press "Mode" button to adjust to "10" in tempeture display zone, then choose "01" enter into long-distance monitoring mode by pressing the "Up" and "Down" buttons.
 - 2) When setting is over, press "OK/Cancel" or "Swing/Enter" to save the setting and exit. Under the setting status, if no action is taken within 20

seconds, system will exit from the setting and return to the display mode of OFF status. Setting can't be saved in this case.

NOTE:

Address setting and long-distance monitor setting of unitary units can only be achieved through wired controllers, the setting mode of different remote controllers may be different. Please refer to the relevant technical service manual for details.

- (6) If the centralized controller is to be connected with PAC units, connect according to fig.3.9. Each PAC unit is connected with can interface of gateway through COM interface, and gateway 485 interface is connected with A3 and B3 interface of centralized controller.

- (7) Gateway address setting and function code setting:

The gateway address should be set by S1 and S2 together, and the address setting range is 1 ~ 36. The gateway function code setting needs to set the first bit of S3 to on terminal, otherwise the centralized controller will not be able to communicate normally.

NOTE:

A gateway can only be connected to one PAC unit. It is not possible to connect a gateway to multiple units at the same time.

Method 2: The central controller connects to the free match by the method as below:

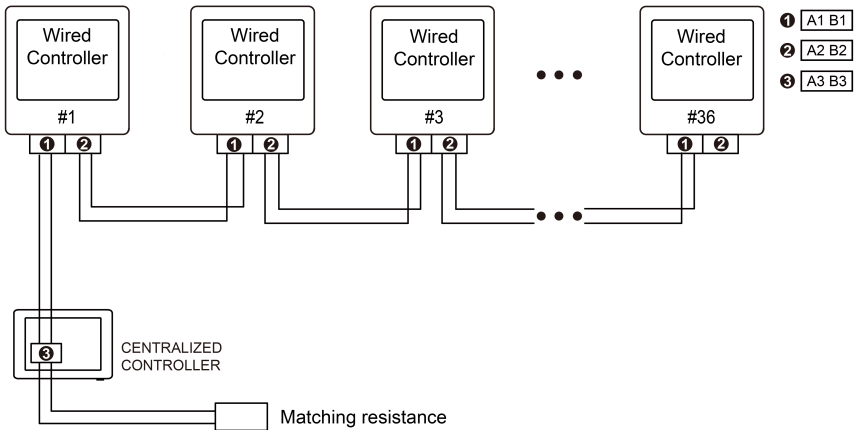

Fig.3.10 Centralized Controller Connected with Wired Controller

Wiring Instructions:

- (1) The connection sketch map of control system is shown by the fig. 3.10.

The complete control system is composed of long-distance central controller, wired controller and telecommunication cable. The wired controller matched with long-distance central controller can support 36 addresses of communication node at the most.

NOTE:

If the centralized controller is to be connected with Wired Controller , communication line (one end is two-core terminal, the other end is the bare wire. Code :420400060252) need to be purchased separately. The quantity of communication line is the quantity of Wired Controller plus 1.

- (2) Wiring terminals of port A3 and port B3 of the central controller or the longdistance controller connect to the corresponding terminal of communication needle stand of #1 wired controller through the telecommunication cable respectively; the other needle stand of #1 wired controller connects to the #2 wired controller through the telecommunication cable and so forth until connect to the #36 wired controller. Except the last wired controller in the control system (only use CN3 or CN4, and the other one will not be connected), there's no the sequence and the importance for the wired controller. The series number in the figure is only for the sake of clarity.
- (3) There is a 2-bit DIP switch on the main board of wired controller As for the last #36 wired controller in the control system, the 1-bit and the 2-bit of the DIP switch should be manually pulled to position "on" and position "off" respectively. The DIP switches of other wired controllers should be kept at the initial ex-factory status (1-bit and 2-bit are set at position "off").
- (4) As for the complete control system, the distance from the long-distance central controller to the communication cable of the last communication node should be less than 500m.

NOTE:

U-match units and free match units can be mixed to connected with centralized controller. The quantity is less than 36.

3.3 Installation Procedure

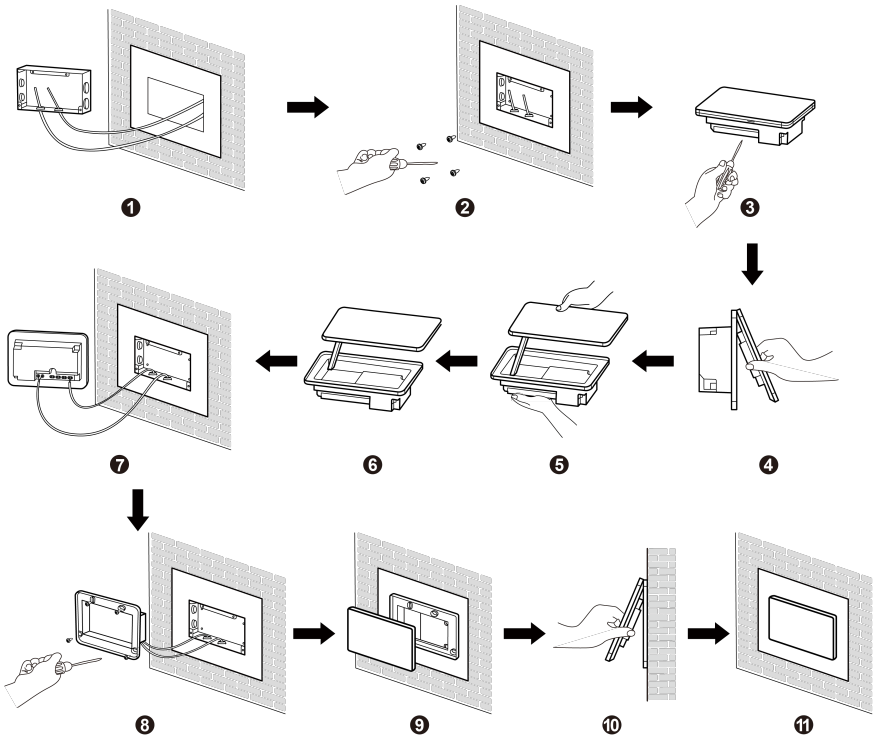

Fig.3.11 Installation Diagram

Unit:mm

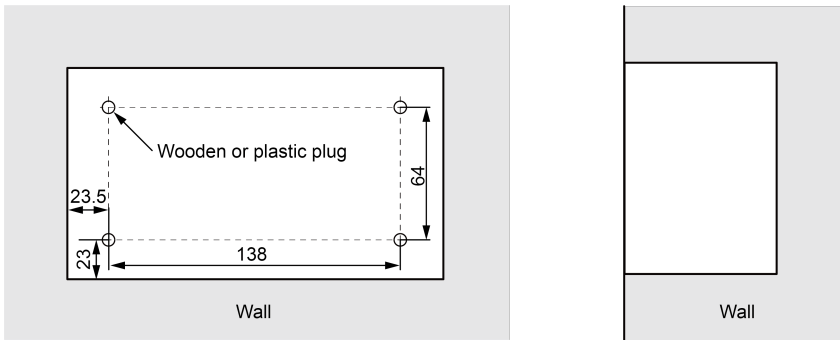

Fig.3.12 Diagram of Wooden or Plastic Plug

Unit:mm

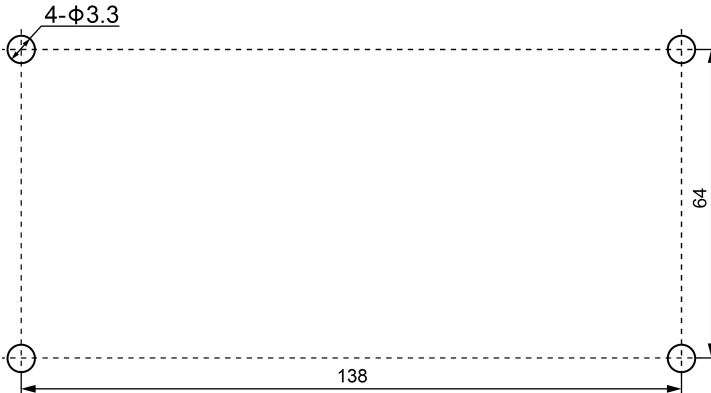



Fig. 3.13 Installation Holes of the Electric Box Rear Cover

Fig.3.11 is a simple installation procedure of centralized controller. Please pay attention to the following matters:

- (1) Before installation, first cut off the power supply of indoor unit. The power must be cut off during the whole installation process.
- (2) During the installation, be careful not to damage to touch screen.
- (3) Before installation, please make the following preparations:
 - 1) In case that the centralized controller is installed on wall, dig a hole that is the size of 180mm×107mm×62mm and peg 4 wooden or plastic plugs on the wall according to fig.3.12.
 - 2) In case that the centralized controller is installed inside the control cabinet, dig 4 installation holes on the surface of the control cabinet according to fig.3.13.
- (4) In step ①, pull out the power core and communication cord, and then lead them separately from the wire orifice of the electric box rear cover. Never lead the cords through a same orifice.
- (5) In step ①, pull out the power core and communication cord, and then lead them separately from the wire orifice of the electric box rear cover. Never lead the cords through a same orifice.
- (6) In step ⑥ pull out the wire connecting the touch screen and controller's rear cover. Put the touch screen on a safe place.

- (7) In step ⑦, connect the communication cords to G1, G2 terminals, and connect the neutral wire and live wire to the N, L terminal; connect the ground wire to position  on the electric box rear cover. Secure it with screw M4×12.
- (8) In step ⑧, locate the controller's rear cover onto the electric box rear cover with screw ST4.2×9.5 MC.
- (9) In step ⑨, connect the wire between touch screen and controller's rear cover.

3.4 Removal Procedure

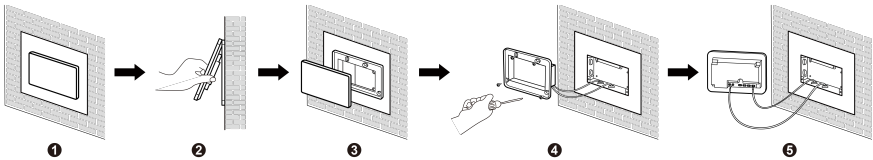

Fig.3.14 Diagram of Removal

4 Display and Working Instructions

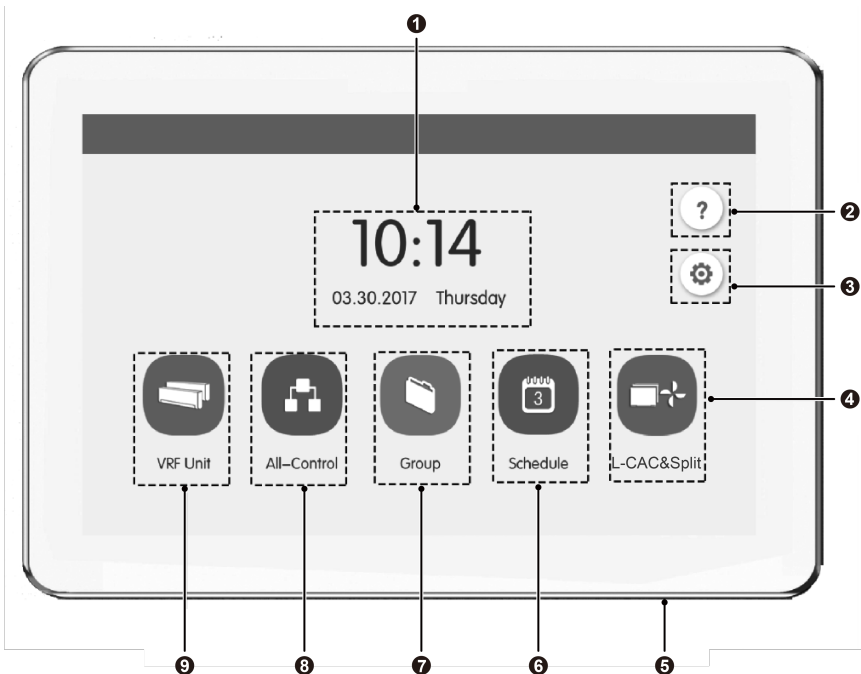



























Fig.4.1 Main Page

4.1 Main Page Display and Buttons

| No. | Name | Instructions |
|-----|--------------------------------------------------------------------------------------------------------------|---------------------------------------------------------------------------------------------------------------------------------------------------------------------------------------------------------------------------|
| 1 | Time zone | The present date, week and time. |
| 2 | Help button  | Press this button to enter Help Info page. |
| 3 | Setting button  | Press this button to enter setting page. |
| 4 | L-CAC&Split unit button  | Press this button to enter L-CAC&Split unit page. |
| 5 | Touch button | <ul style="list-style-type: none"> ● Press the Touch Button to turn on/off the screen of centralized controller. ● Press and hold the Touch Button for 5sec to restart to centralized controller. |
| 6 | Schedule button  | Press this button to enter schedule page. |
| 7 | Group button  | Press this button to enter group page. |
| 8 | All-Control button  | Press this button to enter All-Control page. |
| 9 | VRF Unit button  | Press this button to enter indoor units, water/floor units or fresh air units control page. |

4.2 General Buttons

| Display | Name | Meaning | Display | Name | Meaning |
|-------------------------------------------------------------------------------------|---------------|-------------------------------------------------------------------------------|-------------------------------------------------------------------------------------|----------|---------------------------------------------------------------------------------|
|  | Return | Press this button to return to the previous page |  | Cancel | Press this button to cancel the current setting and return to the previous page |
|  | Save | Press this button to save the current setting and return to the previous page |  | Add | Press this button to add schedule |
|  | Group Control | Press this button to enter Group control page |  | IDU Sort | Press this button to enter IDU sort page |
|  | Edit | Press this button to edit the group or schedule |  | Delete | Press this button to delete group or schedule |
|  | Up | Press this button to increase value or select the previous option |  | Down | Press this button to decrease value or select the next option |
|  | Left | Press this button to return back to previous page |  | Right | Press this button to the next page |

| Display | Name | Meaning | Display | Name | Meaning |
|-----------------------------------------------------------------------------------|--------------------|------------------------------------------------------------------------------------|-----------------------------------------------------------------------------------|---------------------|--------------------------------------------------------------------------------------------|
|  | Forward Page Shift | On the IDU sort page, Press this button to move the selected IDU forward one page |  | Backward Page Shift | On the IDU sort page, Press this button to move the selected IDU backward one page |
|  | Forward Shift | On the IDU sort page, Press this button to move the selected IDU forward one place |  | Backward Shift | On the IDU sort page, Press this button to move the selected IDU backward one place |
|  | Info | Press this button to enter Info page |  | Shield | Press this button to conduct shield function of wired controller to nullify such operation |

4.3 Buttons Working Instructions

The centralized controller uses a capacitive touch screen so that user can operate the units by just touching the screen.

Buttons on the screen are presented in the following ways:

(1) Icon

Icon button can be operated directly. See section 2.2 for more details.

(2) Icon + Text

According to the meaning of words, turn on or off or select a certain function, or enter a certain page. This type of button has 2 or 3 kinds of status based on the specific function.

Meaning of status (take Sleep Button as an example):



Thin light indicates invalid/not selectable. Sleep function is invalid and can't be selected. Different cases for models.



Light indicates off/not selected. Sleep function is off. Pressing the grey sleep button can turn on the sleep function.



Dark indicates on/selected. Sleep function is on. Pressing the orange sleep button can turn off the sleep function.

(3) Sliding

Sliding up/down to slide the group and setting page up&down.

(4) Sliding bar

Press and hold the sliding bar to drag up/down or left/right and to adjust the value. For example the backlight setting, etc.

(5) Zone button

On the management pages of schedule, as indicated in fig.2.2 (the home page of schedule), each rectangle frame constitutes a zone button.

Press the zone button, then the turning on/off of corresponding function or the corresponding page will pop in.

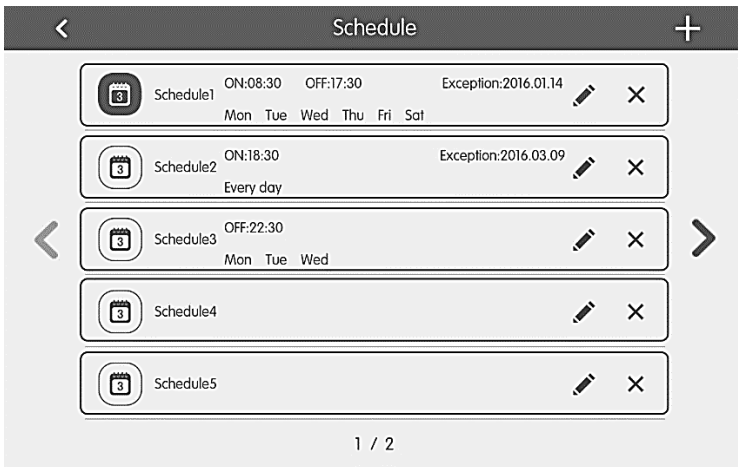

Fig.4.2 Zone Buttons on the Homepage of Schedule

5 Functions Description

5.1 Help Info

On the homepage, press  to enter into help info page.

User can view the information of the simple operation manual.

5.2 VRF Unit

On the homepage, press  to enter into VRF Unit page.

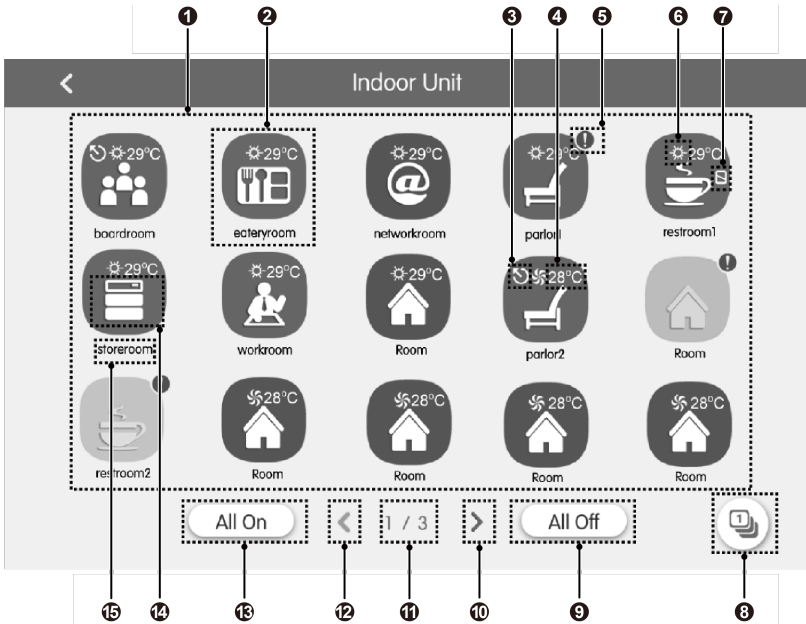











Fig.5.1 Page of VRF Unit

| No. | Name | Instructions |
|-----|-----------------|------------------------------------------------------------------------------------------------------------------------------------------------------------------------------------------------------------------------------------|
| 1 | IDU display | Display in separate page the list of indoor units, water/floor units or fresh air units that are controlled by the centralized controller. |
| 2 | IDU icon | <ul style="list-style-type: none"> ● Press the button to enter the page of indoor units or water/floor units control. ● Light icon indicates that IDU is on while the dark icon indicated that IDU is off. |
| 3 | Master IDU | This icon will be displayed when indoor unit is the master indoor unit of the system. |
| 4 | Set temperature | When indoor unit is on, set temperature will be displayed here. |

| No. | Name | Instructions |
|-----|-------------------|------------------------------------------------------------------------------------------------------------------------------------------------------------------------------------------------------------------------------------------------------------------------------------------------------------------------------------------------------------------------------------------------------------------------------------------------------------------------------------------------------------------------------------------------------------------------------------------------------------------------------------------------------------------------------------------------------------------------------------------------------------------------------------------------------------------------------------|
| 5 | Error status | Error icon will be displayed if indoor unit is malfunctioning. |
| 6 | Operation mode | When indoor unit is on, the current operation mode will be displayed:  Auto  Cooling  Dry  Fan  Heating  Floor heating  Space heating  3D heating |
| 7 | Shield status | This icon will be displayed when indoor unit is in shield status. |
| 8 | IDU Sort | Press the button to enter into the idu sort page. |
| 9 | All Off button | Press this button to turn off all VRF units equipment. |
| 10 | Right page button | Press this button to show the next page idu list. |
| 11 | Current page | The total pages of the controlled indoor unit and the current page. |
| 12 | Left page button | Press this button to show the previous page idu list. |
| 13 | All On button | Press this button to turn on all VRF units equipment. |
| 14 | IDU icon | Display the icon of the VRF units. |
| 15 | IDU name | Display the name of the VRF units. |

Press the  button to enter the IDU sort page.

Select one indoor unit, press the left or right button at the bottom of the screen to switch the display of the indoor units.

5.3 Single Unit Control

On the Page of VRF Unit or group page, press the icon of indoor unit to enter the single unit control.

Press the icon of indoor unit for 5 seconds to pop up the name set of the selected indoor unit.

Parameters of single unit control include parameters of general control and advanced control.

5.3.1 General Control Parameters

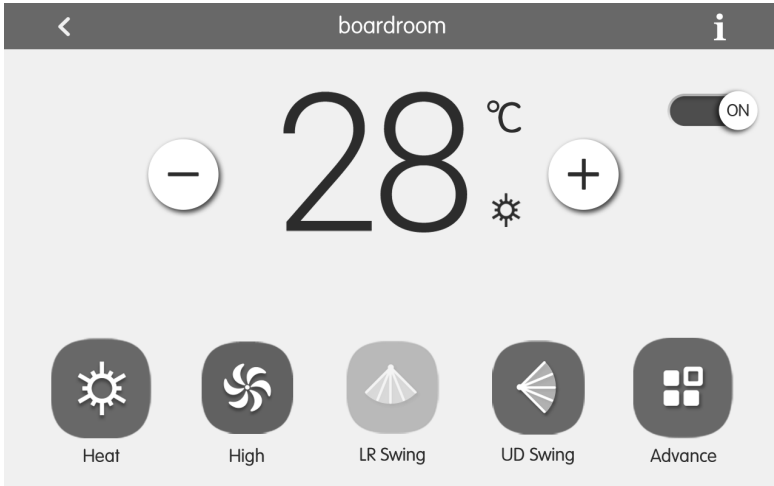

Fig.5.2 Control Page of Single IDU

(1) ON/OFF

Press the on/off button to turn unit on or off.

When unit is turned off, mode, temperature, fan speed and swing can't be set.

(2) Mode setting

Press the Mode buttons to set operation mode.

Modes for indoor units of different series are not all the same.

If a certain mode is not available in the indoor unit, the icon of the corresponding mode cannot be selected.

NOTES:

- ① Auto mode can only be set in the master indoor unit.
 - ② Heat recollection system have no master indoor unit. When the indoor unit of the same branch is connected into one indoor unit, the auto mode can be set; when the quantity of indoor unit in the same branch is more than one set, the auto mode cannot be set; other modes can be freely switched.
- (3) Temperature setting

Press the up or down buttons to adjust temperature. Each time pressing the button will increase/decrease the temperature by 1. Holding down the button can increase/decrease temperature continuously.

Pressing the **i** button can display the “indoor temp” and “outdoor temp”.

(4) Fan speed setting

Press the fan speed button to set fan speed.

NOTE: Unit defaults to low fan speed in drying mode. Fan speed cannot be set in drying or floor heating mode.

(5) Swing setting

Pressing the button “Up&Down Swing” or “Left&Right Swing” can turn on or off the swing function.

NOTE: Swing types for indoor units of different series are not all the same.

(6) Malfunction View

When indoor unit fails to function well, the **i** will turn red. then press the button to view the information of malfunctions.

5.3.2 Advanced Control Parameters

Press Advance Button to enter the advance page.

Press icon buttons to turn on or off the corresponding function.

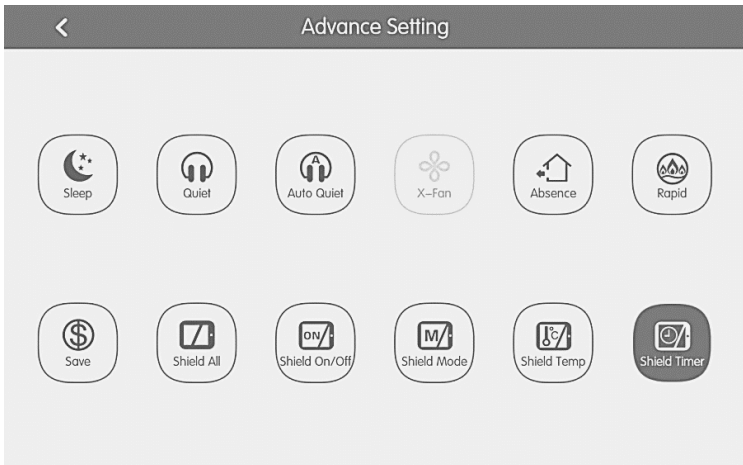

Fig.5.3 Advance Page

- (1) Functions of Sleep, Quiet, Auto Quiet, X-Fan, Absence, Rapid and Save can only be effective when unit is turned on.
- (2) When sleep function is on, auto quiet function will be turned on subsequently. Sleep function will not be effective under auto, fan or floor heating mode.
- (3) Absence function can only be turned on in heating mode. When absence function is on, set temperature is 8°C.
- (4) Rapid cool function can only be effective in cool mode. Likewise, rapid heat function can only be effective in heat mode.
- (5) When shield all function is on, other shield buttons will be invalid.

NOTE:

When centralized controller is matching with different units, some functions will also be different for different unit.

5.4 Water/Floor Control

On the Page of VRF Unit, press the icon of water/floor unit to enter the water/floor control interface. Press the icon of water/floor unit for 5 seconds to pop up the name set of the selected indoor unit.

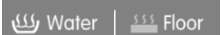
Water/Floor control parameters include water heating control parameter and floor heating control parameter. It can be switched via  button.

NOTES:

- ① When there is only one function can be selected (water or floor), it can only display the water heating or floor heating function interface, and cannot be switched to another interface;
- ② Only when it is connected to hot water generator, water heating and floor heating functions are applicable, the interface can be switched and displaced according to the above instructions.

5.4.1 Water Control Parameter

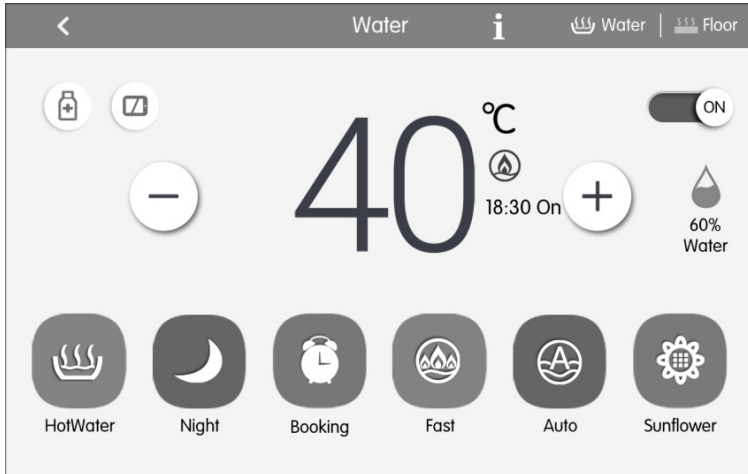

Fig. 5.4 Page of Water heating Control

(1) On/Off

Press the on/off button to turn unit on or off.

When the unit is off, it cannot set the mode, temperature and preset function, while it can set the sterilization function.

(2) Mode Setting

Press the Mode buttons to set unit's operation mode.



There are three modes: HotWater, Booking, Night. These three modes can not be simultaneously conducted, it can only choose one of the modes.

HotWater mode: the water tank or hot water generator will start up or stop heating water according to the current set water temperature.

Booking mode: book the water heating time, the water tank or hot water generator will start up the unit in advance according to the actual water temperature, and will decide the on and off of water tank or hot water generator according to the temperature difference between actual water temperature and the setting water temperature. The water tank or hot water generator will close down the unit 1~4 hours later after the preset time. Once this mode is set, it will circularly operate every day.

Night mode: the fixed period for providing hot water is from 00:00 to 06:00, the water tank or hot water generator will start up in this period, and will decide the on and off of water tank or hot water generator according to the temperature difference between actual water temperature and the setting water temperature. If it is not within this period, the water tank or hot water generator will close down the unit. Once this mode is set, it will circularly operate every day.

(3) Temperature Setting

It displays the current temperature of hot water as default. The temperature value will turn to the setting temperature and can be adjusted by pressing  and  buttons; the temperature value will increase or decrease by every pressing the button for once. The temperature value will be continuously increased or decreased by long pressing the button. After 5 seconds without any action, the temperature value will turn back to the current temperature.

Under the standard HotWater, Booking and Night modes, the temperature setting range is: 35°C~the maximal adjustable temperature 55°C, the acquiescence maximal temperature is 50°C.

(4) Available Hot Water Volume



The water volume can be display in real time, there are five sections of water volume: 100%, 80%, 60%, 40%, 20%, when the water volume is less than 20%, it will flicker.

(5) Function Setting of Water Heating



Under on /off status of water heating, the following functions can be set:

| Water On/Off | Functions |
|-----------------------|----------------------------------------------|
| Start-up Water mode | Sunflower, Auto, Sterilization, Fast, Shield |
| Start-up Booking mode | Auto, Sterilization, Fast, Shield |
| Start-up Night mode | Auto, Sterilization, Fast, Shield |
| Water heating off | Sterilization, Shield |

Sunflower function: find the highest outdoor temperature by recording the history data of outdoor temperature to define the time to heat the water, so as to achieve energy saving.

Auto function: the setting temperature of water heating will be automatically provided by water heater according to the outdoor ambient temperature, there is no need to set by the user, and the water temperature cannot be adjusted via  or  buttons.

Sterilization function: it will conduct high temperature sterilization when the water temperature in the water tank is heated to 65~70°C (adjustable) within the required set time. Press the  button to enter the sterilize page, when the high temperature sterilization is set to be “once”, then the sterilization will be valid for once; when the high temperature sterilization is set to be “circular”, the sterilization will be circularly valid, then it can set the circulated days and presetting sterilization time. When the sterilization function is activated, the icon will flicker.

Fast function: start up the compressor and electric heating water under the allowable conditions of outdoor unit, it displays , the fast water heating function can be set to be valid for once, when the water tank/hot water generator has reached to heat preservation status, it displays , the fast water heating function will be cancelled for energy saving. After the water heating is closed down, the fast water heating function is cancelled.

Shield function: it can conduct shield function by pressing  of wired controller to nullify such operation.

(6) Malfunction View

When the water heater fails to function well, press  to view the information of malfunctions.

5.4.2 Floor control parameter

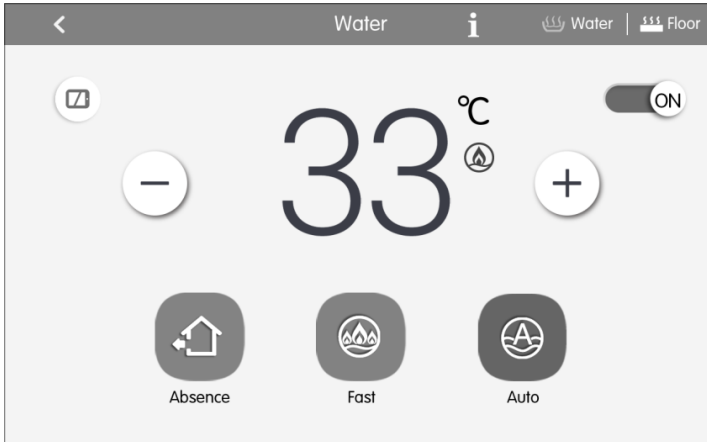



Fig. 5.5 Page of Floor Heating Control

(1) On/off

Press the on/off button to turn unit on or off.

When the unit is off, the mode and temperature cannot be set.

(2) Temperature Setting



It displays the current water yielding temperature as default. The temperature value will turn to the setting temperature and can be adjusted by pressing  and  buttons; the temperature value will increase or decrease by every pressing the button for once. The temperature value will be continuously increased or decreased by long pressing the button. After 5 seconds without any action, the temperature value will turn back to the current water yielding temperature.

Floor heating water yielding temperature range: 25°C~ the highest water yielding temperature of floor heating 45°C.

(3) Function Setting of Floor Heating

Under the on/off status of floor heating, the functions can be set as below:

| Floor on/off | Function | Remarks |
|--------------|-----------------------------|------------------------------------------------------------------------------|
| Floor on | Auto, Fast, Absence, Shield | |
| Floor off | Absence, Shield | It will be valid only when the indoor unit is set together with shunt valve. |

Auto function: the floor heating water yielding temperature will be automatically provided by hot water generator according to the outdoor ambient temperature, there is no need to set by the user, and the water temperature cannot be adjusted via  or  buttons.

Fast function: start up the compressor and electric heating under the allowable conditions of outdoor unit.

Absence function: when the user is absence, it will maintain certain degree of water temperature to prevent the pipelines from being frozen up and prevent the indoor equipment from being destroyed.

Shield function: it can conduct shield function by pressing  of wired controller to nullify such operation.

(4) Malfunction View

When the floor heating fails to function well, press  button to view the information of malfunctions.

NOTE:

The water/floor only support single unit control. Central, group and schedule control can't be supported at present.

5.5 Fresh Air Control

On the Page of VRF Unit, press the fresh air icon for 5 seconds to pop up the fresh air name, project number and icon settings; click fresh air icon to enter fresh air control interface.

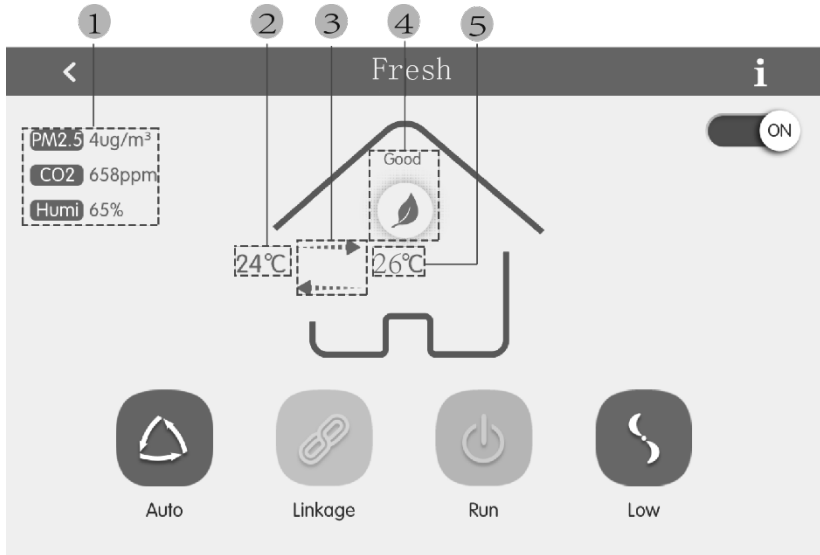

Fig. 5.6 Page of Fresh Air Control

| No. | Name | Instruction |
|-----|-----------------------------------------------------------|--------------------------------------------------------------------------------------------------------------------------------------------------------------------------------------------------------------------------------------------------------------------------------------|
| ① | Parameter display zone of air box | <ul style="list-style-type: none"> ● Display indoor PM2.5, CO₂ and humidity. “- -” will be displayed when air box is not connected ● Upper and lower limits of PM2.5, CO₂ and humidity display keep the same as those in Section 6.2.5 |
| ② | Fresh air inlet temperature | Display fresh air inlet temperature |
| ③ | Unit operation mode | <ul style="list-style-type: none"> ● Means bypass mode or low temperature mode ● Means discharge mode ● Means heat exchange mode |
| ④ | Air quality class | Air quality is classified into six classes, which are excellent, good, moderate, bad, heavy pollution, serious pollution |
| ⑤ | Return air inlet temperature/fresh air outlet temperature | Display fresh air return temperature/fresh air outlet temperature |

(1) On/Off

Press On/Off button to turn on or turn off the unit.

When the unit is off, mode and fan speed cannot be set. Operation mode and inlet fresh air temperature are not displayed.

Note: The fresh air unit which is connected with air box will display PM2.5, CO₂, indoor humidity and air quality class; when air box is not connected, PM2.5, CO₂ and indoor humidity will display “- -”. Air quality class will be concealed.

(2) Mode setting

Press Mode button to set control mode.

Note: Only the fresh air unit which is connected with air box can set auto mode. The fresh air unit which is not connected with air box cannot select auto mode.

(3) Fan speed setting

Click Fan Speed button to set fan speed.

Note: Auto fan speed can be selected only in auto mode.

(4) Error inquiry

When fresh air unit occurs error, click  to check detailed error information.

Note: The fresh air unit only supports single control, and does not support centralized, group and schedule control for the time being.

5.6 All-Control Function

On the homepage, press  to enter into the page of All-Control.



Fig.5.7 All-Control Page

All-Control Function can operate all indoor units as below:

(1) ON/OFF

Press ON/OFF button to turn on or turn off all units.

When turning off the unit, the setting for mode, temperature, fan speed and swing is unavailable.

(2) Mode setting

Press mode button to set operation mode.

(3) Temperature setting

Press UP or Down button to adjust temperature. Press this button once to increase or decrease temperature 1 °C . Press or hold this button and the temperature will increase or decrease continuously.

(4) Fan speed setting

Press or drag the sliding bar of fan speed to set fan speed.

NOTE:

Fan speed defaults at low speed under drying mode and it can't be adjusted.

(5) Swing setting

Press “left&right” swing or “up&down” swing button to turn on or turn off swing function.

(6) Send order

Press button  to send out the All-Control order.

5.7 Group Control





On the homepage, press  to enter into the page of group function.



Fig.5.8 Group Page

| No. | Name | Instructions |
|-----|-------------------------------------------------------------------------------------------------------------|-------------------------------------------------------------------------------------------------------------------------------------------|
| ① | Group display | Display in separate page the list of groups that are controlled by the centralized controller. Sliding up or down can turn over the page. |
| ② | Group names | Display the names of every group. |
| ③ | Add group button | Press the button to add a group. |
| ④ | Group control button  | Press the button to enter the group control page. |
| ⑤ | Group edit button  | Press the button to enter the group edit page. |
| ⑥ | IDU sort button  | Press the button to enter the group sort page. |

(1) Group control

Press the  button to enter the page of group control. Control parameters are the same as single unit control.

Press button  to send out the group control order.

(2) Edit group

Press  to enter the page of group editing.

User can set the group name and add indoor units to the group.

Press  to save the setting.

NOTE:

1 set of indoor unit can be set in up to 5 groups

(3) IDU sort

Press the  button to enter the IDU sort page.

Select one indoor unit, press the left of right button at the bottom of the screen to switch the display of the indoor units.

(4) Add group

Press the “ADD ” button to add new groups. Then the page of group editing will pop in. User can set the group name and add indoor units to the group.

(5) Delete group

Press  to delete the selected group.

5.8 Schedule Management

On the homepage, press  button to enter into the page of schedule management.

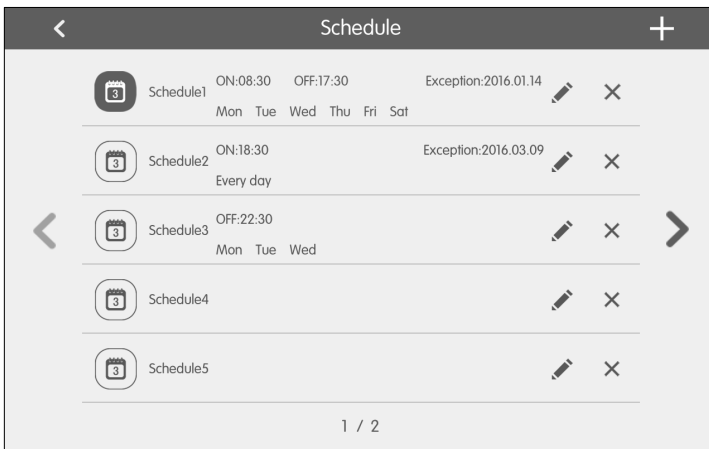

Fig.5.9 Schedule Page

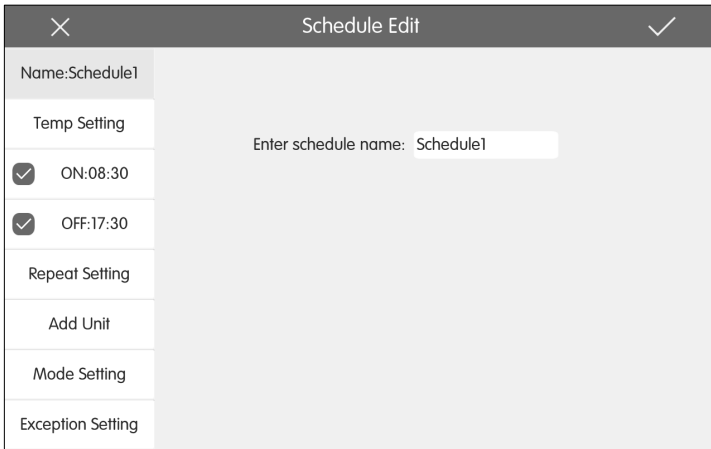

Fig.5.10 Page of Schedule Editing

(1) Open the schedule

Press the zone button to open or close the schedule.

When the icons and texts turn blue indicating the schedule is open.

When the icons and texts turn grey indicating the schedule is closed.

When schedule is open, centralized controller will send out the control order automatically according to the time and parameters set by the schedule.

(2) Edit schedule

Press  to enter the page of schedule editing.

Press  to save the schedule setting.

1) Setting method of schedule control parameters is the same with that of the single indoor unit control.

2) Add equipment

Press the “Add Unit” button to enter the page of equipment selection. User may set the indoor unit that works according to the current schedule.

NOTE:

schedule of L-CAC&Split Centralized Controller can add L-CAC&Split units. For a same indoor unit, different schedules can be set at the same time. In this case, unit will work according to the schedule setting that is previously energized.

3) Repeat schedule

Press “Repeat Setting” button to enter the setting page. User can set the schedule work repeatedly according to weeks.

4) Time setting

Press the “ON Time” or “OFF Time” button to enter the page of time setting. User can set the time for unit to turn on/off automatically.

NOTE:

The time to activate or stop unit can be set at the same time, but they must not be the same.

5) Add exception

Press the “Exception Setting” button to enter the setting page of schedule exception.

The calendar will pop in user can select the date to activate or cancel exception. Press  to save the selected date.

NOTE:

When schedule exception has been set, air conditioner will not execute the control order on the exception date set by the schedule.

User may add several exception dates.

When the gate control function is on, the schedule setting is executed when the gate control card is inserted, but not when the card is pulled out. When there is an indoor unit without gate control function in the schedule, the indoor unit without gate control function will follow the schedule setting of indoor unit with gate control by default.

(3) Add schedule

Press  to add new schedules. Then the schedule editing page will pop in for user to set relevant parameters.

NOTE:

User may add up to 28 schedules.

(4) Delete schedule

Press  to delete the selected schedule.

5.9 L-CAC&Split Unit

5.9.1 L-CAC&Split unit Control

On the homepage, press  to enter the Control Page.

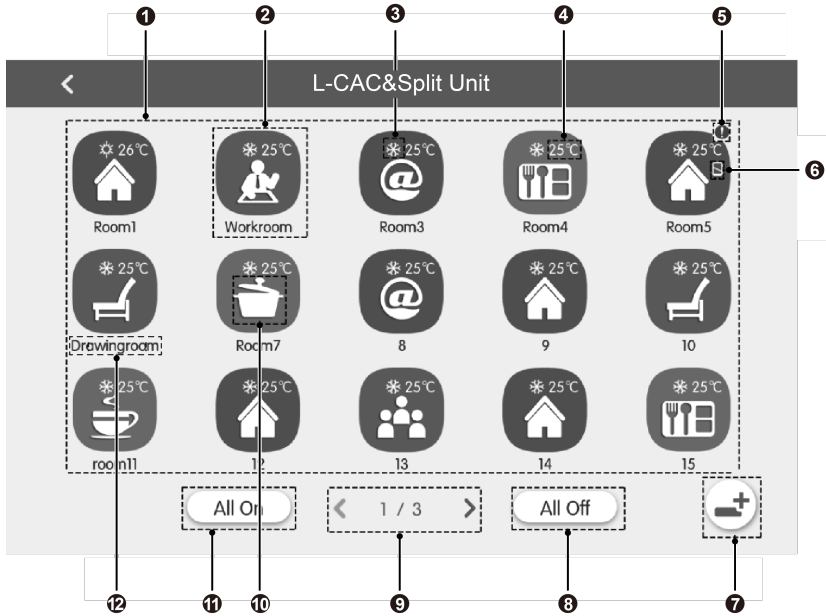







Fig.5.11 L-CAC&Split unit homepage

| No. | Name | Instructions |
|-----|-------------------------------|------------------------------------------------------------------------------------------------------------------------------------------------------------------------------------------------------------------------------------------------------------------------------------------------------------------------------------------------------------------------------------------------------------------------------------------------------------------------------------------------------------------------------------------------|
| 1 | L-CAC&Split unit display zone | Display the list of units controlled by the central controller. |
| 2 | L-CAC&Split unit icon buttons | Press the button to enter the control page of a single unit. Bright icon indicates the corresponding unit is ON and dark icon indicates the corresponding unit is OFF. Press and hold the icon to enter the page of name and icon settings. |
| 3 | Icon of running mode | When indoor unit is ON, its running mode will be displayed in the following way:  auto  cool  dry  fan  heat |
| 4 | Icon of set temperature | Display when the unit is ON. It means set temperature of the device. |
| 5 | Icon of malfunction | If the unit is with trouble, this icon will be shown. |

| No. | Name | Instructions |
|-----|------------------------------------|-------------------------------------------------------------------------------------|
| 6 | Icon of shielding status | If the unit is in shielding status, this icon will be shown. |
| 7 | L-CAC&Split unit registration icon | Press the icon to enter the registration page for the unit. |
| 8 | All off button | Press the icon to turn off all the units. |
| 9 | Page turning | Press this icon to turn pages. |
| 10 | L-CAC&Split unit icon | Display the current L-CAC&Split unit icon. |
| 11 | All on button | Press the icon to turn on all the units. Then units will run according to memories. |
| 12 | L-CAC&Split unit name | Display the current L-CAC&Split unit name. |

Before using, press the registration icon and enter the registration page. Register the L-CAC&Split units that are going to be controlled. Centralized controller can support the control of 36 units at most.

Press and hold L-CAC&Split unit icon for 5S to enter the page of settings. Then you may set the name and icon for the unit.

L-CAC&Split unit control parameters include general control parameters and advanced control parameters.

NOTES:

- ① The functions of group control and engineering setting of the Centralized controller are only applicable to multi VRF units. L-CAC&Split unit do not have the above function.
- ② When in the function of All-central control, all the Multi-VRF unit and L-CAC&Split unit are controlled, but L-CAC&Split unit not controlled by advance setting.

5.9.2 General Control Parameters



Fig.5.12 Control Page of Single IDU

(1) ON/OFF

Press the On/Off button to turn unit on or off.

When unit is off, mode, fan mode and fan speed cannot be set.

(2) Mode setting

Press the mode icon to set the running mode. There are five mode including Auto, Cool, Fan, Heat and Dry.

(3) Temperature setting

Press the up/down button to adjust temperature. Each press will increase or decrease temperature by 1 degree. Holding the button will increase or decrease temperature continuously.

(4) Fan speed setting

Press the fan speed icon to set fan speed.

(5) Swing setting

Pressing the button “Up&Down Swing” or “Left&Right Swing” can turn on or off the swing function.

NOTE:

Swing types for indoor units of different series are not all the same.

(6) Malfunction View

If unit is malfunctioning, **i** turns red. Press this icon to view detailed information about the malfunction.

5.9.3 Advanced Control Parameters

Press the advanced button to enter the advanced page.

Press the icons to turn on or off related functions.

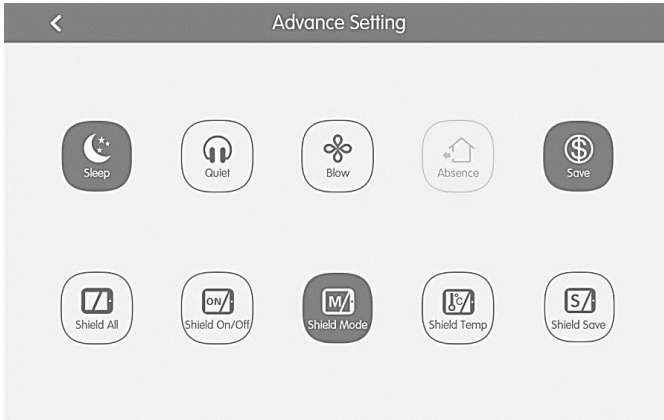

Fig.5.13 L-CAC&Split unit advanced page

- (1) The functions of Sleep, Quiet, Blow, Absence, Energy Saving are only effective under ON status.
- (2) Absence function can only be enabled in Heat mode. When Absence function is enabled, set temperature is 8°C.
- (3) When All Shield function is enabled, other shield buttons are ineffective.

5.10 Local Setting

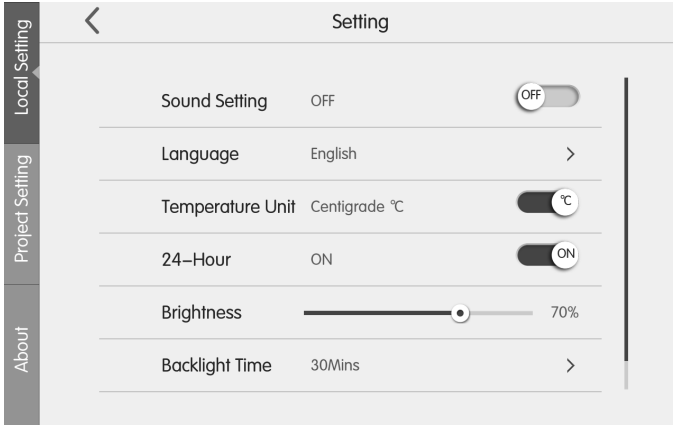



Fig.5.14 Setting Page

On the homepage,press  button to enter into the setting page.

Press the “Local Setting” button to switch to the setting options of the current unit.

Select the needed option at the left side column. Sliding up and down can turn over the page.

Set the corresponding content at the right side.

Local setting includes:

- (1) Sound, temperature unit, time format, 0.5°C switch

Mutual exclusion. Press the button to select one kind of setting.

NOTE:

The 0.5 degree function is only effective at centigrade.When 0.5°C is turned on, the temperature will be increased or decreased by 0.5°C

- (2) Language

Press the button can select system language,such as English,Simplified Chinese ,Traditional Chinese ,Spanish ,French ,Portuguese ,German ,Turkish , Russian , Italian , Dutch.

- (3) Time setting

Set the date and time of the centralized controller system, can also set the VRF unit time if needed and Set the date and time of daylight saving time(DST).

- (4) User password

Press the button can activate or inactivate user password.

When password is activated, it can be set or changed in 4~10 numbers or characters. Original password is blank.

Press the button  to save the password.

NOTE:

If user password is activated, user needs to input password to enter the control page when centralized controller is turned on or activated.

(5) Backlight setting

Pressing this button can set the timeout period of screen backlight. Screen will be shut off and the centralized controller will enter sleep mode when the timeout period is over.

NOTE:

When centralized controller is in sleep mode, use can wake it up by touching any part of the touch screen or the touch button at the right bottom of the screen.

(6) Brightness

Pressing or dragging the sliding bar can adjust the backlight degree.

(7) Customer Service

User can set the name and phone number of the local customer service center for the convenience of acquiring immediate solutions and technical support.

Press the  button to save the setting.

(8) View Selecting

Press the "View Selecting" button, User can select "VRF&CAC&Split"、"VRF Unit View" and "CAC&Split View". Press the  button to save the setting. Main Page keep the selected view style.

(9) Restore default settings

Press the "Reset" button to restore local setting, group setting, schedule setting, names and icons of indoor units, and other relevant ex-factory default settings.

- 1) When switching between indoor network and outdoor network, or reset unit IP, restore the ex-factory setting for centralized controller.
- 2) After debugging for the centralized controller is finished, connect in to the network. If connect the centralized controller to the network during debugging process, it needs to restore the defaulted ex-factory setting.

5.11 Engineering Setting

On the home page, press  to enter into setting page.

Press the “Project Setting” button to switch to engineering setting, the operation method is the same as the setting of this unit.

(1) Indoor unit register

Enter into the indoor unit register interface, select the chosen indoor unit according to the displayed engineering No. of indoor unit icon, and then press  to save, it will display the registered indoor unit in the indoor unit page.

NOTES:

- ① There are 255 sets of indoor units can be registered at most.
- ② If internal or external main boards are replaced or outdoor unit SA2 address dial code is changed.it need to re-register indoor units.

(2) Name&Icon setting

Switch to name&Icon setting interface to select the engineering No., and set the name and icon of indoor unit.

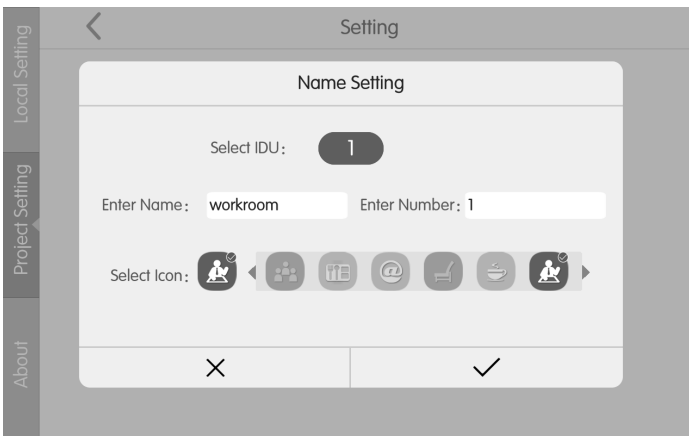



Fig. 5.15 Setting Page of Indoor Unit

Press the Engineering No. to select the required indoor unit that needs to be set.

- 1) Name: can input number or letter (it should not be over 10 letters)
- 2) Icon: press to select the preset icon.
- 3) Engineering No.: it can be set to be 1-255.

- 4) Press  button to successfully save the setting. Then the indoor unit list in the home page will display the new name and icon of indoor units.

(3) Advanced Project Settings

Press and hold the “Project Setting” button for 5 seconds to display the advanced project settings when “Local Setting” button is checked on the setting page.

Functions of advanced project setting are below:

- 1) Indoor & Outdoor Unit Setting
Change parameters of indoor or outdoor unit.
- 2) IDU & ODU Parameter View
View parameters of indoor or outdoor unit, including setting and running parameter.
- 3) IDU & ODU Error Check
Check the error log of indoor or outdoor unit.
- 4) View Project NO.
When the view project No. switch is on, indoor address number will display on the wired controller or display panel on indoor unit.
- 5) Project Password setting
Project password is need by most of advanced project settings. The default password is “123456”.
- 6) Emergency
All of the air conditioner units will stop while occurring emergency. The centralized controller support On/Off Signal device connect to F1/F2(fire alarm port) port, DC Voltage 24V~5V is required.
- 7) Data Transmit
Related information of error can be exported to TF card; the configuration files of data base can be exported to the TF card and then export the configuration files of data base to the central controller from the TF card.

5.12 About

On the home page, press  to enter into setting page.

Press the “About” button to switch to about page. The operation method is the same with that of the local setting.

On the page of about, user can view the information of the local unit, customer service information and other notices.

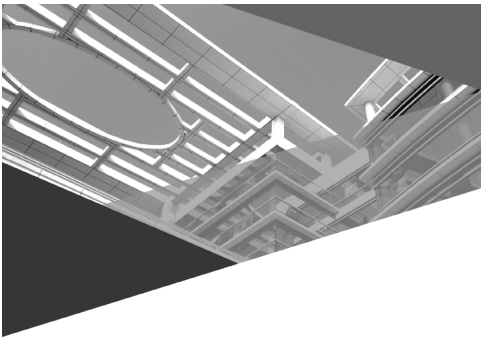

GREE ELECTRIC APPLIANCES, INC. OF ZHUHAI

Add: West Jinji Rd, Qianshan, Zhuhai, Guangdong, China, 519070

Tel: (+86-756) 8522218

Fax: (+86-756) 8669426

E-mail: global@cn.gree.com www.gree.com



66170000014