



# ***Service Manual*** **GMV5 DC Inverter VRF Units**

For North America

Capacity: 72000Btu/h~360000Btu/h

Rated Frequency: 60Hz

Operation Range: Cooling: 23~125.6°F

Heating: -4~75.2°F

# Contents

<b>PREFACE</b> .....	<b>1</b>
<b>SAFTY PRECAUTIONS</b> .....	<b>2</b>
<b>CHAPTER 1 INTRODUCTION TO BASIC FEATURES OF UNITS</b> .....	<b>6</b>
<b>1 MODELS LIST</b> .....	<b>6</b>
<b>2 BASIC OPERATING PRINCIPLE</b> .....	<b>7</b>
<b>3 INTERNAL PIPING DESIGN OF THE UNITS</b> .....	<b>7</b>
3.1 PIPING DIAGRAM OF GMV-72WM/B-F (U) / GMV-72WM/B-U (U) AND GMV-96WM/B-F (U) / GMV-96WM/B-U (U) .....	7
3.2 PIPING DIAGRAM OF GMV-120WM/B-F(U)、GMV-120WM/B-U(U) .....	8
3.3 PIPING DIAGRAM OF GMV-144WM/B1-F (U) .....	9
3.4 PIPING DIAGRAM OF GMV-168WM/B1-F (U) .....	10
3.5 NAMES AND MAIN FUNCTIONS OF COMPONENTS .....	11
<b>4 BASIC PARAMETERS OF UNIT</b> .....	<b>12</b>
<b>5 ELECTRICAL PARAMETERS</b> .....	<b>20</b>
<b>6 CIRCUIT DIAGRAM</b> .....	<b>21</b>
6.1 CIRCUIT DIAGRAM OF GMV-**WM/B-F (U) AND GMV-**WM/B1-F (U).....	21
6.2 CIRCUIT DIAGRAM OF GMV-**WM/B-U (U).....	23
<b>7 UNIT OPERATING TEMPERATURE</b> .....	<b>25</b>
<b>CHAPTER 2 INSTALLATION</b> .....	<b>26</b>
<b>1 ENGINEERING INSTALLATION PREPARATION</b> .....	<b>26</b>
1.1 INSTALLATION SAFETY .....	26
1.2 IMPORTANCE OF INSTALLATION ENGINEERING .....	26
1.3 COOPERATION BETWEEN DIFFERENT PROFESSIONS.....	27
1.4 ONSITE REVIEW OF DESIGN DRAWING.....	30
1.5 CONSTRUCTION ORGANIZATION PROCESS .....	31
<b>2 MATERIAL SELECTION</b> .....	<b>32</b>
2.1 REQUIREMENT FOR SELECTING CONSTRUCTION MATERIALS .....	32
2.2 REQUIREMENT FOR SELECTING MAJOR MATERIALS .....	32
<b>3 INSTALLATION SPACE REQUIREMENT</b> .....	<b>35</b>
3.1 PLACE SELECTION FOR INSTALLING ODU.....	35
3.2 ODU DIMENSIONS AND INSTALLATION HOLE SIZE .....	35
3.3 INSTALLATION SPACE REQUIREMENT FOR ODU .....	37
<b>4 REQUIREMENTS ON FOUNDATION INSTALLATION</b> .....	<b>44</b>
4.1 ODU FOUNDATION .....	44
4.2 ODU FIXING.....	45
4.3 VIBRATION REDUCTION FOR ODU .....	45
<b>5 PIPING CONNECTION</b> .....	<b>46</b>
5.1 SCHEMATIC DIAGRAM OF PIPING CONNECTION.....	46
5.2 SCHEMATIC DIAGRAM OF PIPING SEQUENCE .....	47
5.3 ALLOWABLE PIPE LENGTH AND DROP HEIGHT AMONG INDOOR AND OUTDOOR UNITS .....	50
5.4 CONNECTION PIPE AMONG OUTDOOR MODULES.....	52
5.5 FITTING PIPE BETWEEN OUTDOOR UNIT AND THE FIRST MANIFOLD .....	53
<b>6 PIPE INSTALLATION AND INSULATION</b> .....	<b>58</b>
6.1 PIPE INSTALLATION FOR THE COOLING SYSTEM .....	58
6.2 PIPE INSTALLATION FOR THE CONDENSATE WATER SYSTEM .....	69

6.3. REQUIREMENTS ON INDEPENDENT DRAINAGE FOR EACH IDU .....	72
6.4. REQUIREMENTS ON CENTRALIZED DRAINAGE FOR IDUS .....	73
<b>7 ELECTRIC AND CONTROLLER INSTALLATION .....</b>	<b>74</b>
7.1 PRECAUTIONS .....	75
7.2 INSTALLATION OF THE POWER CABLE .....	76
7.3 INSTALLATION OF THE COMMUNICATION SYSTEM .....	80
<b>8 VACUUMIZATION AND DESICCATION FOR THE REFRIGERANT SYSTEM .....</b>	<b>86</b>
8.1 AIR-TIGHTNESS TEST .....	86
8.2 VACUUMIZATION AND DESICCATION FOR THE SYSTEM .....	87
<b>9 REFRIGERANT PERFUSION .....</b>	<b>88</b>
9.1 CALCULATION METHOD FOR PERFUSING REFRIGERANT .....	88
9.2 METHOD FOR PERFUSING REFRIGERANT .....	91
<b>CHAPTER 3 COMMISSIONING OPERATION .....</b>	<b>94</b>
<b>1 SECURITY REQUIREMENTS .....</b>	<b>94</b>
1.1 PRECAUTIONS FOR CONSTRUCTION .....	94
1.2 PRECAUTIONS FOR THE USE OF REFRIGERANTS .....	94
1.3 FUNCTION SETTINGS OF ODUS .....	94
<b>2 COMMISSIONING PROCESS .....</b>	<b>118</b>
2.1 NECESSITY OF VRF ENGINEERING COMMISSIONING .....	118
2.2 REQUIRED FILES AND TOOLS FOR ENGINEERING COMMISSIONING .....	118
2.3 ENGINEERING COMMISSIONING PROCEDURES .....	119
2.4 REFERENCES FOR PROPER UNIT OPERATION PARAMETERS .....	143
<b>CHAPTER 4 MAINTENANCE .....</b>	<b>144</b>
<b>1 SYSTEM FAILURE CODE TABLE .....</b>	<b>144</b>
<b>2 EXCEPTION AND TROUBLESHOOTING .....</b>	<b>149</b>
2.1 HOW TO LOCATE A FAULTY IDU PROMPTLY .....	149
2.2 FORM ANALYZING .....	150
2.3 SYSTEM FAULTS .....	158
<b>3 KEY PARTS MAINTENANCE .....</b>	<b>264</b>
3.1 CAUTIONS ON CONTROLLER AP1 REPLACEMENT .....	264
3.2 COMPRESSOR REPLACEMENT AND CAUTIONS .....	269
3.3 CAUTIONS ON COMPRESSOR DRIVE REPLACEMENT .....	292
3.4 ASSEMBLING AND DISASSEMBLING KEY PARTS OF ODUS .....	296
3.5 UNIT MAINTENANCE .....	307
<b>4 APPENDIXES .....</b>	<b>308</b>
4.1 MINUTES ABOUT A DEBUG SOLUTION CONFIRMATION MEETING .....	308
4.2 VISUAL INSPECTION CHECKLIST OF THE DEBUG SYSTEM .....	308
4.3 DEBUG PARAMETER RECORD LIST .....	309
4.4 COMMON PARAMETER LISTS .....	310
4.5 EXPLODED VIEWS AND SPARE PART LIST .....	320

# PREFACE

This manual specifies safe operation requirements for GMV5 series VRF units from perspectives of engineering and installation, commissioning and maintenance, as well as basic principles and implementation methods. Professional operators must abide by relevant national (local) safety requirements and technical specifications set forth in this manual during operations; otherwise, the air conditioning system may fail or be damaged, and personnel safety accident may also occur.

# SAFTY PRECAUTIONS

To prevent injury to the user or other people and property damage, the following instructions must be followed.

Incorrect operation due to ignoring instruction will cause harm or damage. The seriousness is classified by the following indications.

	This is the safety alert symbol. It is used to alert you to potential personal injury hazards. Obey all safety messages that follow this symbol to avoid possible injury or death.
<b>WARNING</b>	This mark indicates procedures which, if improperly performed, might lead to the death or serious injury of the user.
<b>CAUTION</b>	This mark indicates procedures which, if improperly performed, might possibly result in personal harm to the user, or damage to property.
<b>NOTICE</b>	NOTICE is used to address practices not related to personal injury.

## **WARNING**

### ■ Installation

**Have all electric work done by a licensed electrician according to "Electric Facility Engineering**

**Standard" and "Interior Wire Regulations" and the instructions given in this manual and always use a special circuit.**

- If the power source capacity is inadequate or electric work is performed improperly, electric shock or fire may result.

**Ask the dealer or an authorized technician to install the air conditioner.**

- Improper installation by the user may result in water leakage, electric shock, or fire.

**Always ground the product.**

- There is risk of fire or electric shock.

**Always install a dedicated circuit and breaker.**

- Improper wiring or installation may cause fire or electric shock.

**For re-installation of the installed product, always contact a dealer or an Authorized Service Center.**

- There is risk of fire, electric shock, explosion, or injury.

**Do not install, remove, or re-install the unit by yourself (customer).**

- There is risk of fire, electric shock, explosion, or injury.

**Do not store or use flammable gas or combustibles near the air conditioner.**

- There is risk of fire or failure of product.

**Use the correctly rated breaker or fuse.**

- There is risk of fire or electric shock.

**Prepare for strong wind or earthquake and install the unit at the specified place.**

- Improper installation may cause the unit to topple and result in injury.

**Do not install the product on a defective installation stand.**

- It may cause injury, accident, or damage to the product.

**When installing and moving the air conditioner to another site, do not charge it with a different refrigerant from the refrigerant specified on the unit.**

- If a different refrigerant or air is mixed with the original refrigerant, the refrigerant cycle may malfunction and the unit may be damaged.

**Do not reconstruct to change the settings of the protection devices.**

- If the pressure switch, thermal switch, or other protection device is shorted and operated forcibly, or parts other than those specified by GREE are used, fire or explosion may result.

**Ventilate before operating air conditioner when gas leaked out.**

- It may cause explosion, fire, and burn.

**Securely install the cover of control box and the panel.**

- If the cover and panel are not installed securely, dust or water may enter the outdoor unit and fire or electric shock may result.

**If the air conditioner is installed in a small room, measures must be taken to prevent the refrigerant concentration from exceeding the safety limit when the refrigerant leaks.**

- Consult the dealer regarding the appropriate measures to prevent the safety limit from being exceeded. Should the refrigerant leak and cause the safety limit to be exceeded, hazards due to lack of oxygen in the room could result.

**■Operation****Do not damage or use an unspecified power cord.**

- There is risk of fire, electric shock, explosion, or injury.

**Use a dedicated outlet for this appliance.**

- There is risk of fire or electrical shock.

**Be cautious that water could not enter the product.**

- There is risk of fire, electric shock, or product damage.

**Do not touch the power switch with wet hands.**

- There is risk of fire, electric shock, explosion, or injury.

**When the product is soaked (flooded or submerged), contact an Authorized Service Center.**

- There is risk of fire or electric shock.

**Be cautious not to touch the sharp edges when installing.**

- It may cause injury.

**Take care to ensure that nobody could step on or fall onto the outdoor unit.**

- This could result in personal injury and product damage.

**Do not open the inlet grille of the product uring operation. (Do not touch the electrostatic filter, if the unit is so equipped.)**

- There is risk of physical injury, electric shock, or product failure.



### ■Installation

**Always check for gas (refrigerant) leakage after installation or repair of product.**

- Low refrigerant levels may cause failure of product.

**Do not install the product where the noise or hot air from the outdoor unit could damage the neighborhoods.**

- It may cause a problem for your neighbors.

**Keep level even when installing the product.**

- To avoid vibration or water leakage.

**Do not install the unit where combustible gas may leak.**

- If the gas leaks and accumulates around the unit, an explosion may result.

**Use power cables of sufficient current carrying capacity and rating.**

- Cables that are too small may leak, generate heat, and cause a fire.

**Do not use the product for special purposes, such as preserving foods, works of art, etc. It is a consumer air conditioner, not a precision refrigeration system.**

- There is risk of damage or loss of property.

**Keep the unit away from children. The heat exchanger is very sharp.**

• It can cause the injury, such as cutting the finger. Also the damaged fin may result in degradation of capacity.

**When installing the unit in a hospital, communication station, or similar place, provide sufficient protection against noise.**

• The inverter equipment, private power generator, high-frequency medical equipment, or radio communication equipment may cause the air conditioner to operate erroneously, or fail to operate. On the other hand, the air conditioner may affect such equipment by creating noise that disturbs medical treatment or image broadcasting.

**Do not install the product where it is exposed to sea wind (salt spray) directly.**

• It may cause corrosion on the product. Corrosion, particularly on the condenser and evaporator fins, could cause product malfunction or inefficient operation.

### ■Operation

**Do not use the air conditioner in special environments.**

• Oil, steam, sulfuric smoke, etc. can significantly reduce the performance of the air conditioner or damage its parts.

**Do not block the inlet or outlet.**

- It may cause failure of appliance or accident.

**Make the connections securely so that the outside force of the cable may not be applied to the terminals.**

- Inadequate connection and fastening may generate heat and cause a fire.

**Be sure the installation area does not deteriorate with age.**

- If the base collapses, the air conditioner could fall with it, causing property damage, product failure,

or personal injury.

**Install and insulate the drain hose to ensure that water is drained away properly based on the installation manual.**

- A bad connection may cause water leakage.

**Safely dispose of the packing materials.**

• Packing materials, such as nails and other metal or wooden parts, may cause stabs or other injuries.

• Tear apart and throw away plastic packaging bags so that children may not play with them. If children play with a plastic bag which was not torn apart, they face the risk of suffocation.

Turn on the power at least 6 hours before starting operation.

• Starting operation immediately after turning on the main power switch can result in severe damage to internal parts. Keep the power switch turned on during the operational season.

**Be very careful about product transportation.**

• Only one person should not carry the product if it weighs more than 44lbs (20kg).  
• Some products use PP bands for packaging. Do not use any PP bands for a means of transportation. It is dangerous.

• Do not touch the heat exchanger fins. Doing so may cut your fingers.

• When transporting the outdoor unit, suspending it at the specified positions on the unit base. Also support the outdoor unit at four points so that it cannot slip sideways.

**Do not touch any of the refrigerant piping during and after operation.**

- It can cause a burn or frostbite.

**Do not operate the air conditioner with the panels or guards removed.**

- Rotating, hot, or high-voltage parts can cause injuries.

**Do not directly turn off the main power switch after stopping operation.**

• Wait at least 5 minutes before turning off the main power switch. Otherwise it may result in water leakage or other problems.

**Auto-addressing should be done in condition of connecting the power of all indoor and outdoor units. Auto-addressing should also be done in case of changing the indoor unit PCB.**

**Use a firm stool or ladder when cleaning or maintaining the air conditioner.**

- Be careful and avoid personal injury.

**Do not insert hands or other objects through the air inlet or outlet while the air conditioner is plugged in.**

- There are sharp and moving parts that could cause personal injury.





# CHAPTER 1 INTRODUCTION TO BASIC FEATURES OF UNITS

## 1 MODELS LIST

208/230V 3~60Hz:

Model	Product Code	Capacity		Ref.	Power Supply	Appearance
		Cooling (Btu/h)	Heating (Btu/h)			
GMV-72WM/B-F(U)	CN851W1380	72000	81000	R410A	208/230V 3~60Hz	
GMV-96WM/B-F(U)	CN851W1390	96000	108000	R410A	208/230V 3~60Hz	
GMV-120WM/B-F(U)	CN851W1420	120000	135000	R410A	208/230V 3~60Hz	
GMV-144WM/B1-F(U)	CN851W2000	144000	162000	R410A	208/230V 3~60Hz	
GMV-168WM/B1-F(U)	CN851W2710	168000	189000	R410A	208/230V 3~60Hz	

460V 3~60Hz:

Model	Product Code	Capacity		Ref.	Power Supply	Appearance
		Cooling (Btu/h)	Heating (Btu/h)			
GMV-72WM/B-U(U)	CN851W2070	72000	81000	R410A	460V 3~60Hz	
GMV-96WM/B-U(U)	CN851W1990	96000	108000	R410A	460V 3~60Hz	
GMV-120WM/B-U(U)	CN851W2040	120000	135000	R410A	460V 3~60Hz	

# 2 BASIC OPERATING PRINCIPLE

Outdoor units of GMV5 VRF air conditioner can be implemented by combining multiple modules in parallel. Similarly, indoor units (IDUs) consist of multiple units connecting in parallel. The operating principle is as follows: When an IDU is operating in cooling mode, the outdoor unit (ODU) can correspondingly enable the outdoor module based on the operating load requirement of the IDU. The outdoor heat exchanger serves as a system condenser, and the heat exchangers of cooling IDUs are connected in parallel to serve as a system evaporator. The circulation of air supply and air return of the IDU is performed to adjust the indoor temperature and humidity. When an IDU is operating in heating mode, all four-way valves in the ODU module are switched into energized status. The outdoor heat exchange serves as the system evaporator, and the heat exchanger of the IDU serves as the system condenser. The circulation of air supply and air return of the IDU is performed to adjust the indoor temperature and humidity.

# 3 INTERNAL PIPING DESIGN OF THE UNITS

## 3.1 Piping Diagram of GMV-72WM/B-F (U) / GMV-72WM/B-U (U) and GMV-96WM/B-F (U) / GMV-96WM/B-U (U)

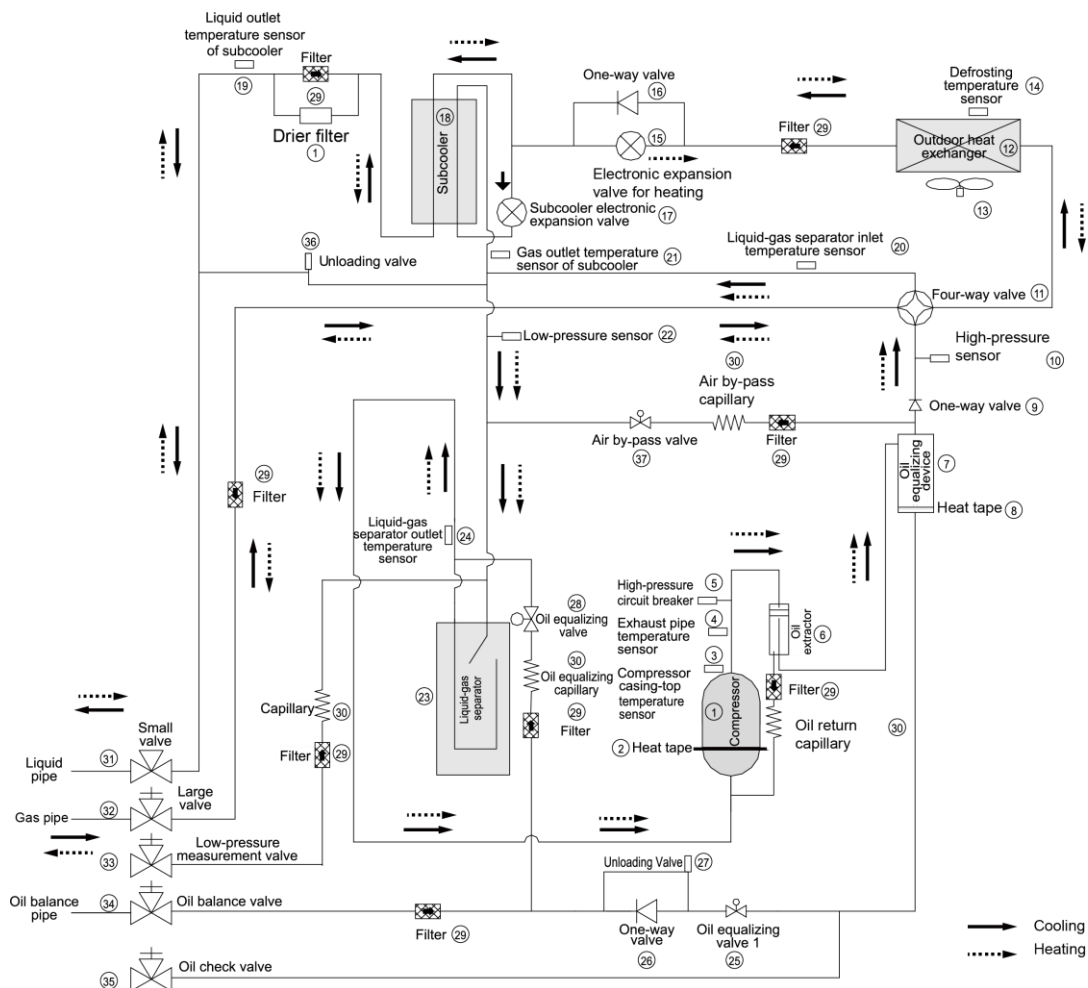

### 3.2 Piping Diagram of GMV-120WM/B-F(U), GMV-120WM/B-U(U)

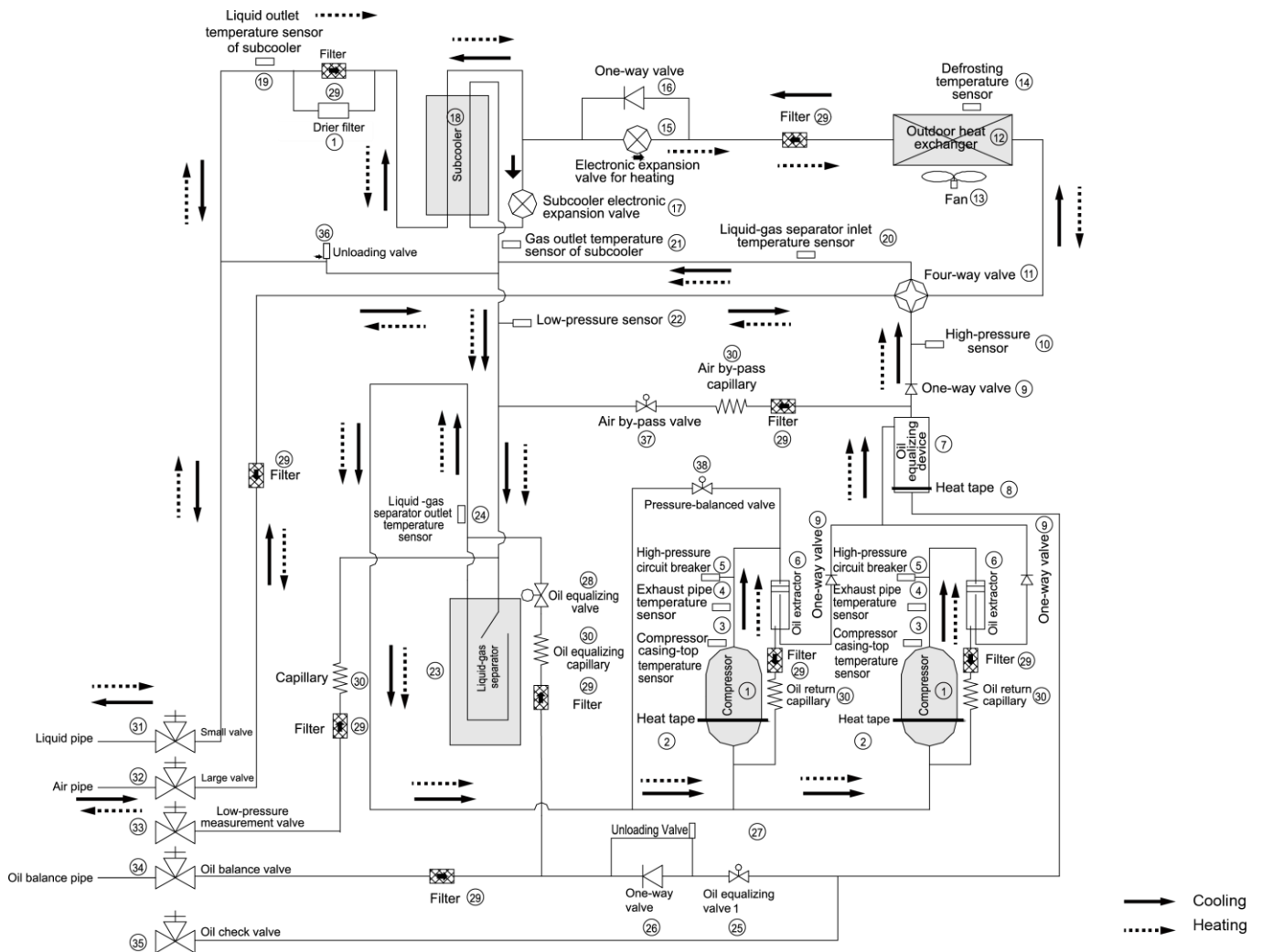

### 3.3 Piping Diagram of GMV-144WM/B1-F (U)

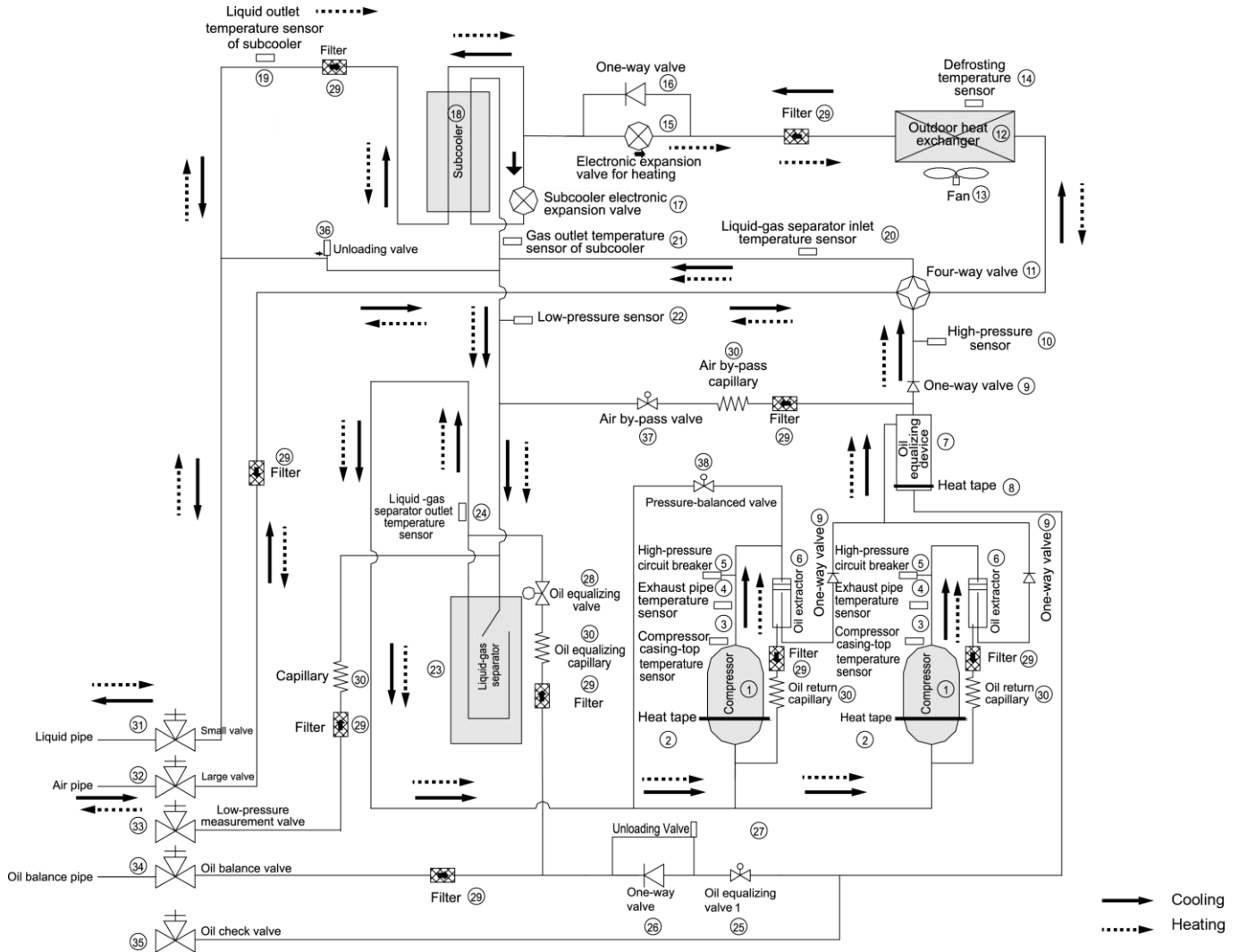

### 3.4 Piping Diagram of GMV-168WM/B1-F (U)

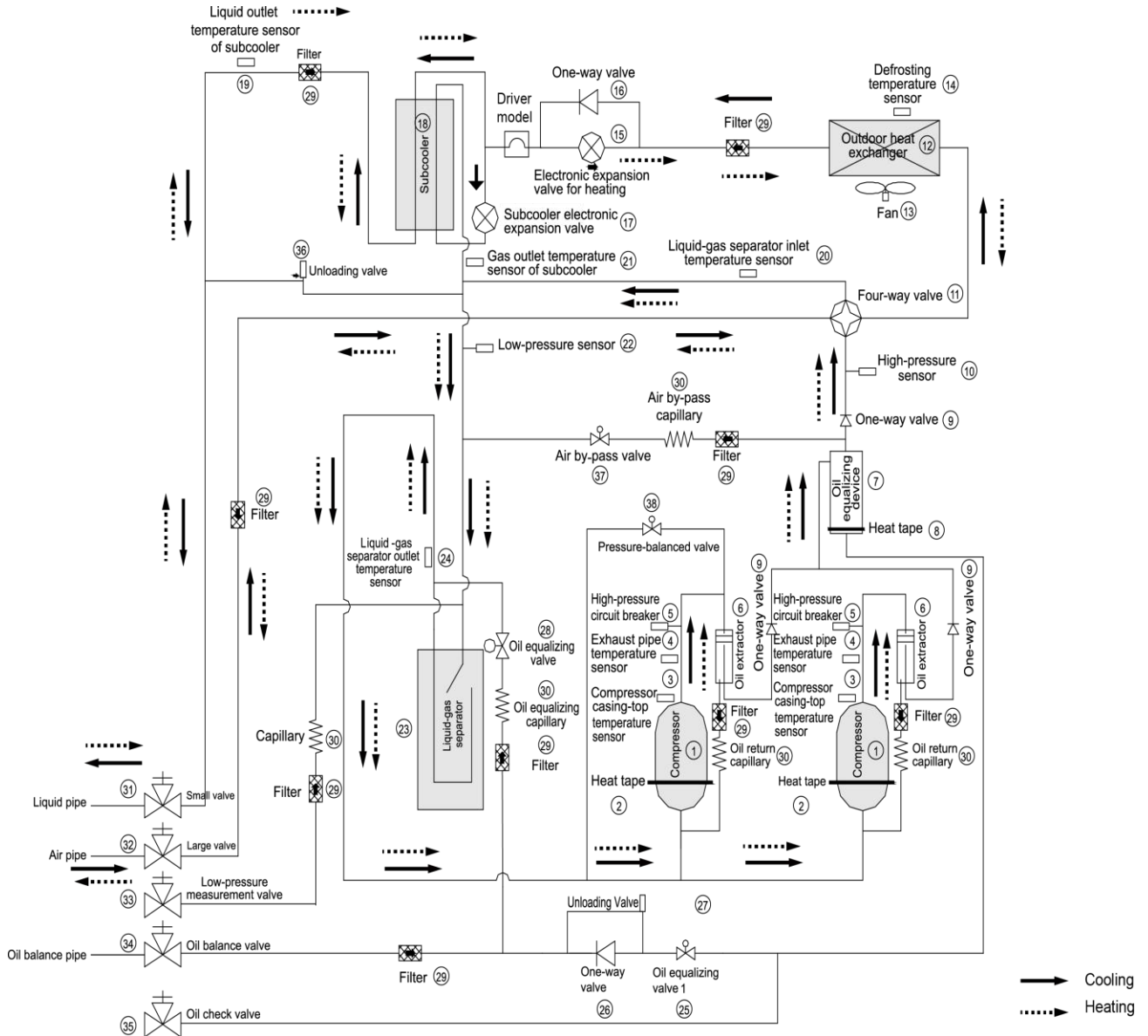

### 3.5 Names and Main Functions of Components

No	Name	Main Function
1	Compressor	Adjusts its own rotational speed based on the actual requirement of the system to implement capacity control.
2	Compressor heat tape	Maintains a proper oil temperature in the compressor when the compressor is in standby status, ensuring the reliability during compressor startup.
3	Compressor casing-top temperature sensor	Detects a compressor's exhaust gas temperature for compressor control and protection.
4	Exhaust pipe temperature sensor of compressor	Detects a compressor's exhaust gas temperature for compressor control and protection.
5	High-pressure circuit breaker	Protects a compressor by sending feedback signal to stop the system when the compressor's discharge temperature exceeds the operating value of high-pressure circuit breaker.
6	Oil extractor	Separates the gas and oil in the system to ensure compressor reliability.
7	Oil balance device	Equalizes the oil for all modules in the case of excess oil in the current module when multiple modules are arranged in parallel, thus ensuring the system reliability.
8	Heat tape of oil balance device	Maintains a proper oil temperature in the compressor when the compressor is in standby status, ensuring the reliability of compressor startup.
9	One-way valve	Prevents high-pressure gas from entering the compressor and fast balances the suction pressure and discharge pressure in a compressor.
10	High-pressure sensor	Detects the high pressure value in the system in real time mode for compressor protection and other control functions.
11	Four-way valve	Used for the switching between the cooling and heating functions of system IDU.
12	Heat exchanger	Used for outdoor heat exchange.
13	Fan	Strengthens heat exchanging.
14	Defrosting temperature sensor	Used for defrosting detection.
15	Electronic expansion valve for heating	Controls refrigerant adjustment in heating mode.
16	One-way valve	Controls refrigerant flow direction.
17	Subcooler electronic expansion valve	Controls the degree of subcooling of tube refrigerant when the system is running in cooling mode, and reduces the capacity loss on pipes.
18	Subcooler	Controls the degree of subcooling of tube.
19	Liquid outlet temperature sensor of subcooler	Detects tube temperature.
20	Inlet temperature sensor of gas-liquid separator	Detects the inlet temperature of gas-liquid separator to prevent the system from running when the refrigerant flows back to the compressor.
21	Gas outlet temperature sensor of subcooler	Detects gas temperature of subcooler.
22	Low-pressure sensor	Detects system low pressure to avoid extra-low operating pressure.
23	Gas-liquid separator	Separate gas and liquid to prevent the system from running when the refrigerant flows back to the compressor.
24	Outlet temperature sensor of gas-liquid separator	Detects internal status of gas-liquid separator to further control the compressor suction performance.
25	Oil balance valve 1	Used for oil balance control among modules.
26	One-way valve	Used for oil balance control among modules and avoid reverse flow of oil.
27	Unloading valve	Avoids over-high pressure caused by pipeline blind spot.
28	Oil balance valve 2	Used for oil balance control among modules.
29	Filter	Prevents impurities from entering components and parts.
30	Capillary tube	Supports flow regulating and pressure reduction.

No	Name	Main Function
31	Liquid valve	Stop valve, closed when the unit is delivered from the factory and will be opened after installation.
32	Gas valve	Stop valve, closed when the unit is delivered from the factory and will be opened after installation.
33	Low-pressure measurement valve	Detects the low pressure value or charges refrigerant during system running.
34	Oil balance valve	Stop valve, closed when the unit is delivered from the factory and will be opened after installation.
35	Oil check valve	Checks the quality of refrigerating machine oil of compressor during maintenance.
36	Unloading valve	Avoid over-high pressure caused by pipeline blind spot.
37	Air by-pass valve	Avoids extra-high or low operating pressure.
38	Pressure-balanced valve	Ensures success startup of compressor.

## 4 BASIC PARAMETERS OF UNIT

GMV-\*\*\*WM/B-F (U) and GMV-\*\*\*WM/B1-F (U)

Outdoor Units_Heat Pump	—	6Ton	8Ton	10Ton	12Ton	14Ton	
Model	—	GMV-72WM/B-F(U)	GMV-96WM/B-F(U)	GMV-120WM/B-F(U)	GMV-144WM/B1-F(U)	GMV-168WM/B1-F(U)	
Module (combined)	—	—	—	—	—	—	
Cooling capacity	Btu/h	72000	96000	120000	144000	168000	
Heating capacity	Btu/h	81000	108000	135000	162000	189000	
Air volume	CFM	6710	8240	8240	8240	9416	
Max. external static pressure	Pa	82	82	82	82	82	
Noise(sound level)	dB(A)	60	61	63	64	65	
Power		208/230V 3~60Hz	208/230V 3~60Hz	208/230V 3~60Hz	208/230V 3~60Hz	208/230V 3~60Hz	
Input power for cooling	kW	5.45	7.30	10.00	12.00	14.00	
Input power for heating	kW	5.80	7.85	10.50	12.50	14.25	
Input current for cooling	A	16.42	20.37	26.27	39.2	45.7	
Input current for heating	A	17.29	23.50	27.87	40.8	46.5	
MOP	A	35	45	60	70	70	
MCA	A	31	37	50	55	57	
Compressor type	—	Inverter Scroll	Inverter Scroll	Inverter Scroll	Inverter Scroll	Inverter Scroll	
Compressor quantity	N	1	1	2	2	2	
Refrigeration oil no. of compressor	—	FVC68D or FV68H	FVC68D or FV68H	FVC68D or FV68H	FVC68D or FV68H	FVC68D or FV68H	
Oil Charge	Compressor	L	1.1	1.1	1.1+0.5	1.1+1.1	1.1+1.1
	Oil separate tank	L	3.5	4	5	5	5
	Total	L	4.6	5.1	6.6	7.2	7.2
Ambient temperature range for cooling	°F	23~125.6	23~125.6	23~125.6	23~125.6	23~125.6	
Ambient temperature range of heating	°F	-4~75.2	-4~75.2	-4~75.2	-4~75.2	-4~75.2	
Refrigerant type	—	R410A	R410A	R410A	R410A	R410A	
Charging volume of refrigerant	oz	229.3	398.7	412.7	412.7	412.7	

Outdoor Units_Heat Pump	—	6Ton	8Ton	10Ton	12Ton	14Ton
Model	—	GMV-72WM/B-F(U)	GMV-96WM/B-F(U)	GMV-120WM/B-F(U)	GMV-144WM/B1-F(U)	GMV-168WM/B1-F(U)
Max. quantity of connected indoor unit	unit	13	16	19	23	29
Size of gas pipe	in.	Φ3/4	Φ7/8	Φ1-1/8	Φ1-1/8	Φ1-1/8
Size of liquid pipe	in.	Φ3/8	Φ3/8	Φ1/2	Φ1/2	Φ5/8
Size of oil-balanced pipe	in.	Φ3/8	Φ3/8	Φ3/8	Φ3/8	Φ3/8
Outline dimension(WxDxH)	in.	36-5/8x30-1/8x63-1/4	52-3/4x30-1/8x63-1/4	52-3/4x30-1/8x63-1/4	52-3/4x30-1/8x63-1/4	52-3/4x30-1/8x68-1/2
Packing size(WxDxH)	in.	39-3/4x33-1/8x69-7/8	55-7/8x33-1/8x69-7/8	55-7/8x33-1/8x69-7/8	55-7/8x33-1/8x69-7/8	55-7/8x33-1/8x75-1/4
Net weight	LBS	496	662	794	794	849
Gross weight	LBS	518	695	827	827	882

Outdoor Units_Heat Pump	—	12Ton	14Ton	16Ton
Model	—	GMV-144WM/B-F(U)	GMV-168WM/B-F(U)	GMV-192WM/B-F(U)
Module (combined)	—	GMV-72WM/B-F(U)+GMV-72WM/B-F(U)	GMV-72WM/B-F(U)+GMV-96WM/B-F(U)	GMV-96WM/B-F(U)+GMV-96WM/B-F(U)
Cooling capacity	Btu/h	144000	168000	192000
Heating capacity	Btu/h	162000	189000	216000
Air volume	CFM	6710+6710	6710+8240	8240+8240
Max. external static pressure	Pa	82	82	82
Power		208/230V 3~ 60Hz	208/230V 3~ 60Hz	208/230V 3~ 60Hz
Input power for cooling	kW	5.45+5.45	5.45+7.3	7.3+7.3
Input power for heating	kW	5.80+5.80	5.80+7.85	7.85+7.85
Input current for cooling	A	16.42+16.42	16.42+20.37	20.37+20.37
Input current for heating	A	17.29+17.29	17.29+23.50	23.50+23.50
MOP	A	35+35	35+45	45+45
MCA	A	31+31	31+37	37+37
Refrigeration oil no. of compressor	—	FVC68D or FV68H	FVC68D or FV68H	FVC68D or FV68H
Ambient temperature range for cooling	°F	23~125.6	23~125.6	23~125.6
Ambient temperature range of heating	°F	-4~75.2	-4~75.2	-4~75.2
Refrigerant type	—	R410A	R410A	R410A
Charging volume of refrigerant	oz	229.3+229.3	229.3+398.7	398.7+398.7
Max. quantity of connected indoor unit	unit	23	29	33
Size of gas pipe	in.	Φ1-1/8	Φ1-1/8	Φ1-1/8
Size of liquid pipe	in.	Φ1/2	Φ5/8	Φ5/8
Size of oil-balanced pipe	in.	Φ3/8	Φ3/8	Φ3/8
Outline dimension(WxDxH)	in.	(36-5/8x30-1/8x63-1/4) x2	(36-5/8x30-1/8x63-1/4) +(52-3/4x30-1/8x63-1/4)	(52-3/4x30-1/8x63-1/4) x2
Packing size(WxDxH)	in.	/	/	/
Net weight	LBS	496+496	496+662	662+662
Gross weight	LBS	518+518	518+695	695+695



Outdoor Units_Heat Pump	—	18Ton	20Ton	22Ton
Model	—	GMV-216WM/B-F(U)	GMV-240WM/B-F(U)	GMV-264WM/B-F(U)
Module (combined)	—	GMV-96WM/B-F(U)+ GMV-120WM/B-F(U)	GMV-120WM/B-F(U)+ GMV-120WM/B-F(U)	GMV-72WM/B-F(U)+ GMV-96WM/B-F(U)+ GMV-96WM/B-F(U)
Cooling capacity	Btu/h	216000	240000	264000
Heating capacity	Btu/h	243000	270000	297000
Air volume	CFM	8240+8240	8240+8240	6710+8240+8240
Max. external static pressure	Pa	82	82	82
Power		208/230V 3~ 60Hz	208/230V 3~ 60Hz	208/230V 3~ 60Hz
Input power for cooling	kW	7.30+10.00	10.00+10.00	5.45+7.3+7.3
Input power for heating	kW	7.85+10.50	10.50+10.50	5.80+7.85+7.85
Input current for cooling	A	20.37+26.27	26.27+26.27	16.42+20.37+20.37
Input current for heating	A	23.50+27.87	27.87+27.87	17.29+23.50+23.50
MOP	A	45+60	60+60	35+45+45
MCA	A	37+50	50+50	31+37+37
Refrigeration oil no. of compressor	—	FVC68D or FV68H	FVC68D or FV68H	FVC68D or FV68H
Ambient temperature range for cooling	°F	23~125.6	23~125.6	23~125.6
Ambient temperature range of heating	°F	-4~75.2	-4~75.2	-4~75.2
Refrigerant type	—	R410A	R410A	R410A
Charging volume of refrigerant	oz	398.7+412.7	412.7+412.7	229.3+398.7+398.7
Max. quantity of connected indoor unit	unit	36	39	46
Size of gas pipe	in.	Φ1-1/8	Φ1-3/8	Φ1-3/8
Size of liquid pipe	in.	Φ5/8	Φ5/8	Φ3/4
Size of oil-balanced pipe	in.	Φ3/8	Φ3/8	Φ3/8
Outline dimension(WxDxH)	in.	(52-3/4x30-1/8x63-1/4) x2	(52-3/4x30-1/8x63-1/4) x2	(36-5/8x30-1/8x63-1/4) +(52-3/4x30-1/8x63-1/4)x2
Net weight	LBS	662+794	794+794	496+662+662
Gross weight	LBS	695+827	827+827	518+695+695

Outdoor Units_Heat Pump	—	24Ton	26Ton	28Ton	30Ton
Model	—	GMV-288WM/B-F(U)	GMV-312WM/B-F(U)	GMV-336WM/B-F(U)	GMV-360WM/B-F(U)
Module (combined)	—	GMV-96WM/B-F(U) + GMV-96WM/B-F(U) +GMV-96WM/B-F(U)	GMV-96WM/B-F(U) +GMV-96WM/B-F(U) +GMV-120WM/B-F(U)	GMV-96WM/B-F(U) +GMV-120WM/B-F(U) +GMV-120WM/B-F(U)	GMV-120WM/B-F(U) +GMV-120WM/B-F(U) +GMV-120WM/B-F(U)
Cooling capacity	Btu/h	288000	312000	336000	360000
Heating capacity	Btu/h	324000	351000	378000	405000
Air volume	CFM	8240+8240+8240	8240+8240+8240	8240+8240+8240	8240+8240+8240
Max. external static pressure	Pa	82	82	82	82
Power		208/230V 3~ 60Hz	208/230V 3~ 60Hz	208/230V 3~ 60Hz	208/230V 3~ 60Hz
Input power for cooling	kW	7.30+7.30+7.30	7.30+7.30+10.00	7.30+10.00+10.00	10.00+10.00+10.00
Input power for heating	kW	7.85+7.85+7.85	7.85+7.85+10.50	7.85+10.50+10.50	10.50+10.50+10.50
Input current for cooling	A	20.37+20.37+20.37	20.37+20.37+26.27	20.37+26.27+26.27	26.27+26.27+26.27
Input current for heating	A	23.50+23.50+23.50	23.50+23.50+27.87	23.50+27.87+27.87	27.87+27.87+27.87
MOP	A	45+45+45	45+45+60	45+60+60	60+60+60
MCA	A	37+37+37	37+37+50	37+50+50	50+50+50
Refrigeration oil no. of compressor	—	FVC68D or FV68H	FVC68D or FV68H	FVC68D or FV68H	FVC68D or FV68H
Ambient temperature range for cooling	°F	23~125.6	23~125.6	23~125.6	23~125.6
Ambient temperature range of heating	°F	-4~75.2	-4~75.2	-4~75.2	-4~75.2
Refrigerant type	—	R410A	R410A	R410A	R410A
Charging volume of refrigerant	oz	398.7+398.7+398.7	398.7+398.7+412.7	398.7+412.7+412.7	412.7+412.7+412.7
Max. quantity of connected indoor unit	unit	50	53	56	59
Size of gas pipe	in.	Φ1-3/8	Φ1-3/8	Φ1-3/8	Φ1-5/8
Size of liquid pipe	in.	Φ3/4	Φ3/4	Φ3/4	Φ3/4
Size of oil-balanced pipe	in.	Φ3/8	Φ3/8	Φ3/8	Φ3/8
Outline dimension(WxDxH)	in.	(52-3/4x30-1/8x63-1/4) x3	(52-3/4x30-1/8x63-1/4) x3	(52-3/4x30-1/8x63-1/4) x3	(52-3/4x30-1/8x63-1/4) x3
Packing size(WxDxH)	in.	/	/	/	/
Net weight	LBS	662+662+662	662+662+794	662+794+794	794+794+794
Gross weight	LBS	695+695+695	695+695+827	695+827+827	827+827+827
Maximum qty of connected indoor units	unit	50	53	56	59

## GMV-\*\*WM/B-U (U)

Outdoor Units_Heat Pump		—	6Ton	8Ton	10Ton
Model		—	GMV-72WM/B-U(U)	GMV-96WM/B-U(U)	GMV-120WM/B-U(U)
Module (combined)		—	—	—	—
Cooling capacity		Btu/h	72000	96000	120000
Heating capacity		Btu/h	81000	108000	135000
Air volume		CFM	6710	8240	8240
Max. external static pressure		Pa	82	82	82
Noise (sound level)		dB(A)	60	61	63
Power			460V 3~ 60Hz	460V 3~ 60Hz	460V 3~ 60Hz
Input power for cooling		kW	5.45	7.30	10.00
Input power for heating		kW	5.80	7.85	10.50
Input current for cooling		A	8.05	10.78	14.77
Input current for heating		A	8.56	11.59	15.50
MOP		A	20	25	30
MCA		A	15	18	25
Compressor type		—	Inverter Scroll	Inverter Scroll	Inverter Scroll
Compressor quantity		N	1	1	2
Refrigeration oil no. of compressor		—	FVC68D or FV68H	FVC68D or FV68H	FVC68D or FV68H
Oil Charge	Compressor	L	1.1	1.1	1.1+0.5
	Oil separate tank	L	3.5	4	5
	Total	L	4.6	5.1	6.6
Ambient temperature range for cooling		°F	23~125.6	23~125.6	23~125.6
Ambient temperature range of heating		°F	-4~75.2	-4~75.2	-4~75.2
Refrigerant type		—	R410A	R410A	R410A
Charging volume of refrigerant		oz	229.3	398.7	412.7
Max. quantity of connected indoor unit		unit	13	16	19
Size of gas pipe		in.	Φ3/4	Φ7/8	Φ1-1/8
Size of liquid pipe		in.	Φ3/8	Φ3/8	Φ1/2
Size of oil-balanced pipe		in.	Φ3/8	Φ3/8	Φ3/8
Outline dimension(WxDxH)		in.	36-5/8x30-1/8x63-1/4	52-3/4x30-1/8x63-1/4	52-3/4x30-1/8x63-1/4
Packing size(WxDxH)		in.	39-3/4x33-1/8x69-7/8	55-7/8x33-1/8x69-7/8	55-7/8x33-1/8x69-7/8
Net weight		LBS	503	672	794
Gross weight		LBS	524	705	827

Outdoor Units_Heat Pump	—	12Ton	14Ton	16Ton
Model	—	GMV-144WM/B-U(U)	GMV-168WM/B-U(U)	GMV-192WM/B-U(U)
Module (combined)	—	GMV-72WM/B-U(U)+ GMV-72WM/B-U(U)	GMV-72WM/B-U(U)+ GMV-96WM/B-U(U)	GMV-96WM/B-U(U)+ GMV-96WM/B-U(U)
Cooling capacity	Btu/h	144000	168000	192000
Heating capacity	Btu/h	162000	189000	216000
Air volume	CFM	6710+6710	6710+8240	8240+8240
Max. external static pressure	Pa	82	82	82
Noise (sound level)	dB(A)	/	/	/
Power		460V 3~ 60Hz	460V 3~ 60Hz	460V 3~ 60Hz
Input power for cooling	kW	5.45+5.45	5.45+7.30	7.30+7.30
Input power for heating	kW	5.80+5.80	5.80+7.85	7.85+7.85
Input current for cooling	A	8.05+8.05	8.05+10.78	10.78+10.78
Input current for heating	A	8.56+8.56	8.56+11.59	11.59+11.59
MOP	A	20+20	20+25	25+25
MCA	A	15+15	15+18	18+18
Refrigeration oil no. of compressor	—	FVC68D or FV68H	FVC68D or FV68H	FVC68D or FV68H
Ambient temperature range for cooling	°F	23~125.6	23~125.6	23~125.6
Ambient temperature range of heating	°F	-4~75.2	-4~75.2	-4~75.2
Refrigerant type	—	R410A	R410A	R410A
Charging volume of refrigerant	oz	229.3+229.3	229.3+398.7	398.7+398.7
Max. quantity of connected indoor unit	unit	23	29	33
Size of gas pipe	in.	Φ1-1/8	Φ1-1/8	Φ1-1/8
Size of liquid pipe	in.	Φ1/2	Φ5/8	Φ5/8
Size of oil-balanced pipe	in.	Φ3/8	Φ3/8	Φ3/8
Outline dimension(WxDxH)	in.	(36-5/8x30-1/8x63-1/4) x2	(36-5/8x30-1/8x63-1/4) +(52-3/4x30-1/8x63-1/4)	(52-3/4x30-1/8x63-1/4) x2
Packing size(WxDxH)	in.	/	/	/
Net weight	LBS	503+503	503+672	672+672
Gross weight	LBS	524+524	524+705	705+705

Outdoor Units_Heat Pump	—	18Ton	20Ton	22Ton
Model	—	GMV-216WM/B-U(U)	GMV-240WM/B-U(U)	GMV-264WM/B-U(U)
Module (combined)	—	GMV-96WM/B-U(U)+ GMV-120WM/B-U(U)	GMV-120WM/B-U(U)+ GMV-120WM/B-U(U)	GMV-72WM/B-U(U)+ GMV-96WM/B-U(U)+ GMV-96WM/B-U(U)
Cooling capacity	Btu/h	216000	240000	260000
Heating capacity	Btu/h	243000	270000	297000
Air volume	CFM	8240+8240	8240+8240	6710+8240+8240
Max. external static pressure	Pa	82	82	82
Noise (sound level)	dB(A)	/	/	/
Power		460V 3~ 60Hz	460V 3~ 60Hz	460V 3~ 60Hz
Input power for cooling	kW	7.30+10.00	10.00+10.00	5.45+7.30+7.30
Input power for heating	kW	7.85+10.50	10.50+10.50	5.80+7.85+7.85
Input current for cooling	A	10.78+14.77	14.77+14.77	8.05+10.78+10.78
Input current for heating	A	11.59+15.50	15.50+15.50	8.56+11.59+11.59
MOP	A	25+30	30+30	20+25+25
MCA	A	18+25	25+25	15+18+18
Refrigeration oil no. of compressor	—	FVC68D or FV68H	FVC68D or FV68H	FVC68D or FV68H
Ambient temperature range for cooling	°F	23~125.6	23~125.6	23~125.6
Ambient temperature range of heating	°F	-4~75.2	-4~75.2	-4~75.2
Refrigerant type	—	R410A	R410A	R410A
Charging volume of refrigerant	oz	398.7+412.7	412.7+412.7	229.3+398.7+398.7
Max. quantity of connected indoor unit	unit	36	39	46
Size of gas pipe	in.	Φ1-1/8	Φ1-3/8	Φ1-3/8
Size of liquid pipe	in.	Φ5/8	Φ5/8	Φ3/4
Size of oil-balanced pipe	in.	Φ3/8	Φ3/8	Φ3/8
Outline dimension(WxDxH)	in.	(52-3/4x30-1/8x63-1/4) x2	(52-3/4x30-1/8x63-1/4) x2	(36-5/8x30-1/8x63-1/4) +(52-3/4x30-1/8x63-1/4) x2
Packing size(WxDxH)	in.	/	/	/
Net weight	LBS	672+794	794+794	503+672+672
Gross weight	LBS	705+827	827+827	524+705+705

Outdoor Units_Heat Pump	—	24Ton	26Ton	28Ton	30Ton
Model	—	GMV-288WM/B-U(U)	GMV-312WM/B-U(U)	GMV-336WM/B-U(U)	GMV-360WM/B-U(U)
Module (combined)	—	GMV-96WM/B-U(U) +GMV-96WM/B-U(U) +GMV-96WM/B-U(U)	GMV-96WM/B-U(U) +GMV-96WM/B-U(U) +GMV-120WM/B-U(U)	GMV-96WM/B-U(U) +GMV-120WM/B-U(U) +GMV-120WM/B-U(U)	GMV-120WM/B-U(U) +GMV-120WM/B-U(U) +GMV-120WM/B-U(U)
Cooling capacity	Btu/h	288000	312000	336000	360000
Heating capacity	Btu/h	324000	351000	378000	405000
Air volume	CFM	8240+8240+8240	8240+8240+8240	8240+8240+8240	8240+8240+8240
Max. external static pressure	Pa	82	82	82	82
Noise (sound level)	dB(A)	/	/	/	/
Power		460V 3~ 60Hz	460V 3~ 60Hz	460V 3~ 60Hz	460V 3~ 60Hz
Input power for cooling	kW	7.30+7.30+7.30	7.30+7.30+10.00	7.30+10.00+10.00	10.00+10.00+10.00
Input power for heating	kW	7.85+7.85+7.85	7.85+7.85+10.50	7.85+10.50+10.50	10.50+10.50+10.50
Input current for cooling	A	10.78+10.78+10.78	10.78+10.78+14.77	10.78+14.77+14.77	14.77+14.77+14.77
Input current for heating	A	11.59+11.59+11.59	11.59+11.59+15.50	11.59+15.50+15.50	15.50+15.50+15.50
MOP	A	25+25+25	25+25+30	25+30+30	30+30+30
MCA	A	18+18+18	18+18+25	18+25+25	25+25+25
Refrigeration oil no. of compressor	—	FVC68D or FV68H	FVC68D or FV68H	FVC68D or FV68H	FVC68D or FV68H
Ambient temperature range for cooling	°F	23~125.6	23~125.6	23~125.6	23~125.6
Ambient temperature range of heating	°F	-4~75.2	-4~75.2	-4~75.2	-4~75.2
Refrigerant type	—	R410A	R410A	R410A	R410A
Charging volume of refrigerant	oz	398.7+398.7+398.7	398.7+398.7+412.7	398.7+412.7+412.7	412.7+412.7+412.7
Max. quantity of connected indoor unit	unit	50	53	56	59
Size of gas pipe	in.	Φ1-3/8	Φ1-3/8	Φ1-3/8	Φ1-5/8
Size of liquid pipe	in.	Φ3/4	Φ3/4	Φ3/4	Φ3/4
Size of oil-balanced pipe	in.	Φ3/8	Φ3/8	Φ3/8	Φ3/8
Outline dimension(WxDxH)	in.	(52-3/4x30-1/8x63-1/4)x3	(52-3/4x30-1/8x63-1/4)x3	(52-3/4x30-1/8x63-1/4)x3	(52-3/4x30-1/8x63-1/4)x3
Packing size(WxDxH)	in.	/	/	/	/
Net weight	LBS	672+672+672	672+672+794	672+794+794	794+794+794
Gross weight	LBS	705+705+705	705+705+827	705+827+827	827+827+827

## ▲ CAUTION

No matter how many outdoor units there are, the total rated capacity of indoor units must not exceed 135% of the total rated capacity of outdoor units. Stable and safe operation can only be guaranteed in a range of 50%~135%.

# 5 ELECTRICAL PARAMETERS

208/230V 3~ 60Hz

Model	Power Supply	Fuse Capacity	Minimum Circuit Ampacity	Maximum Overcurrent Protection
	V/Ph/Hz	A	A	A
GMV-72WM/B-F(U)	208V/230V 3~ 60Hz	35	31	35
GMV-96WM/B-F(U)	208V/230V 3~ 60Hz	45	37	45
GMV-120WM/B-F(U)	208V/230V 3~ 60Hz	60	50	60
GMV-144WM/B1-F(U)	208V/230V 3~ 60Hz	70	55	70
GMV-168WM/B1-F(U)	208V/230V 3~ 60Hz	70	57	70
GMV-144WM/B-F(U)	208V/230V 3~ 60Hz	35+35	31+31	35+35
GMV-168WM/B-F(U)	208V/230V 3~ 60Hz	35+45	31+37	35+45
GMV-192WM/B-F(U)	208V/230V 3~ 60Hz	45+45	37+37	45+45
GMV-216WM/B-F(U)	208V/230V 3~ 60Hz	45+60	37+50	45+60
GMV-240WM/B-F(U)	208V/230V 3~ 60Hz	60+60	50+50	60+60
GMV-264WM/B-F(U)	208V/230V 3~ 60Hz	35+45+45	31+37+37	35+45+45
GMV-288WM/B-F(U)	208V/230V 3~ 60Hz	45+45+45	37+37+37	45+45+45
GMV-312WM/B-F(U)	208V/230V 3~ 60Hz	45+45+60	37+37+50	45+45+60
GMV-336WM/B-F(U)	208V/230V 3~ 60Hz	45+60+60	37+50+50	45+60+60
GMV-360WM/B-F(U)	208V/230V 3~ 60Hz	60+60+60	50+50+50	60+60+60

460V 3~ 60Hz

Model	Power Supply	Fuse Capacity	Minimum Circuit Ampacity	Maximum Overcurrent Protection
	V/Ph/Hz	A	A	A
GMV-72WM/B-U(U)	460V 3~ 60Hz	20	15	20
GMV-96WM/B-U(U)	460V 3~ 60Hz	25	18	25
GMV-120WM/B-U(U)	460V 3~ 60Hz	30	25	30
GMV-144WM/B-U(U)	460V 3~ 60Hz	20+20	15+15	20+20
GMV-168WM/B-U(U)	460V 3~ 60Hz	20+25	15+18	20+25
GMV-192WM/B-U(U)	460V 3~ 60Hz	25+25	18+18	25+25
GMV-216WM/B-U(U)	460V 3~ 60Hz	25+30	18+25	25+30
GMV-240WM/B-U(U)	460V 3~ 60Hz	30+30	25+25	30+30
GMV-264WM/B-U(U)	460V 3~ 60Hz	20+25+25	15+18+18	20+25+25
GMV-288WM/B-U(U)	460V 3~ 60Hz	25+25+25	18+18+18	25+25+25
GMV-312WM/B-U(U)	460V 3~ 60Hz	25+25+30	18+18+25	25+25+30
GMV-336WM/B-U(U)	460V 3~ 60Hz	25+30+30	18+25+25	25+30+30
GMV-360WM/B-U(U)	460V 3~ 60Hz	30+30+30	25+25+25	30+30+30

## **▲WARNING**

● Power cable wire gauge and circuit breaker must be selected based on the above parameters and in compliance with local safety requirements. If there is conflict between above parameters and national requirements, please contact the manufacture promptly.

● If power cable wire gauge and circuit breaker is out of the above design range, fire hazard may occur.

# 6 Circuit Diagram

## 6.1 Circuit diagram of GMV-\*\*WM/B-F (U) and GMV-\*\*WM/B1-F (U)

GMV-72WM/B-F (U)

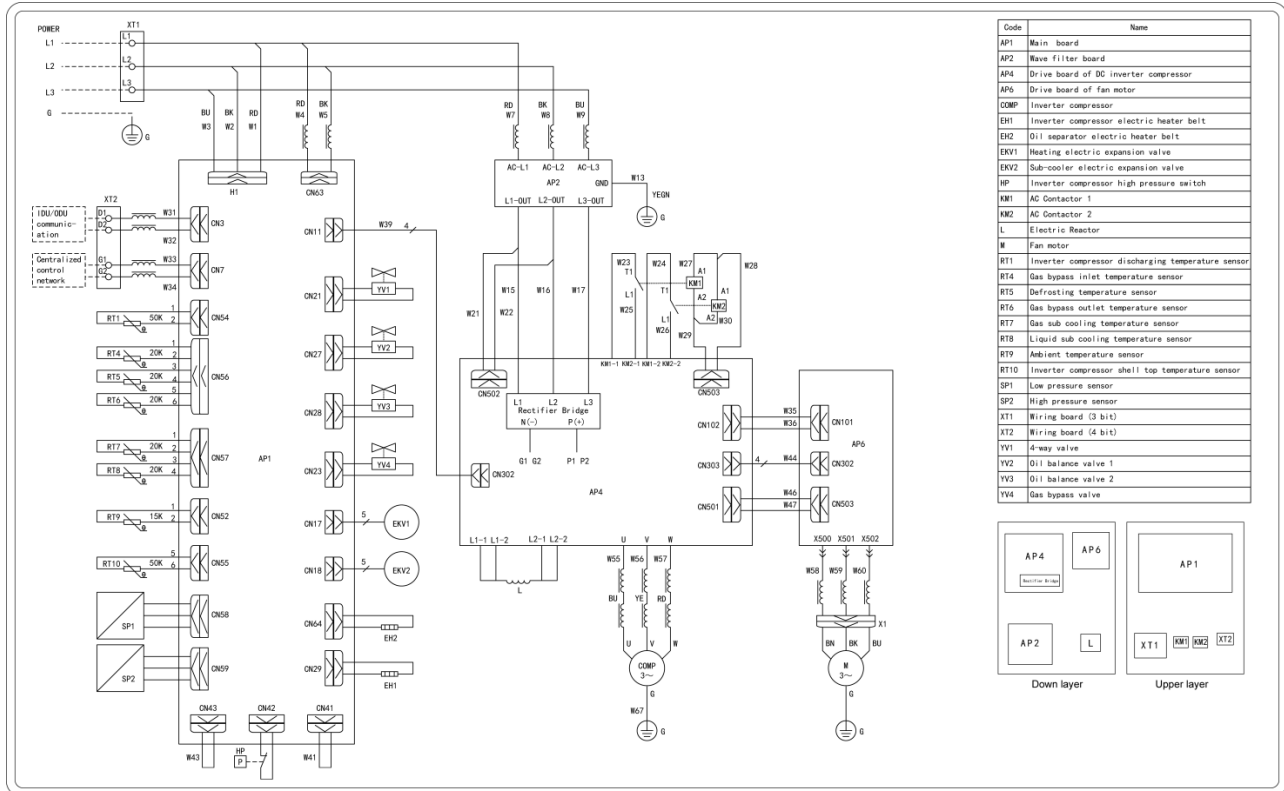

GMV-96WM/B-F (U)

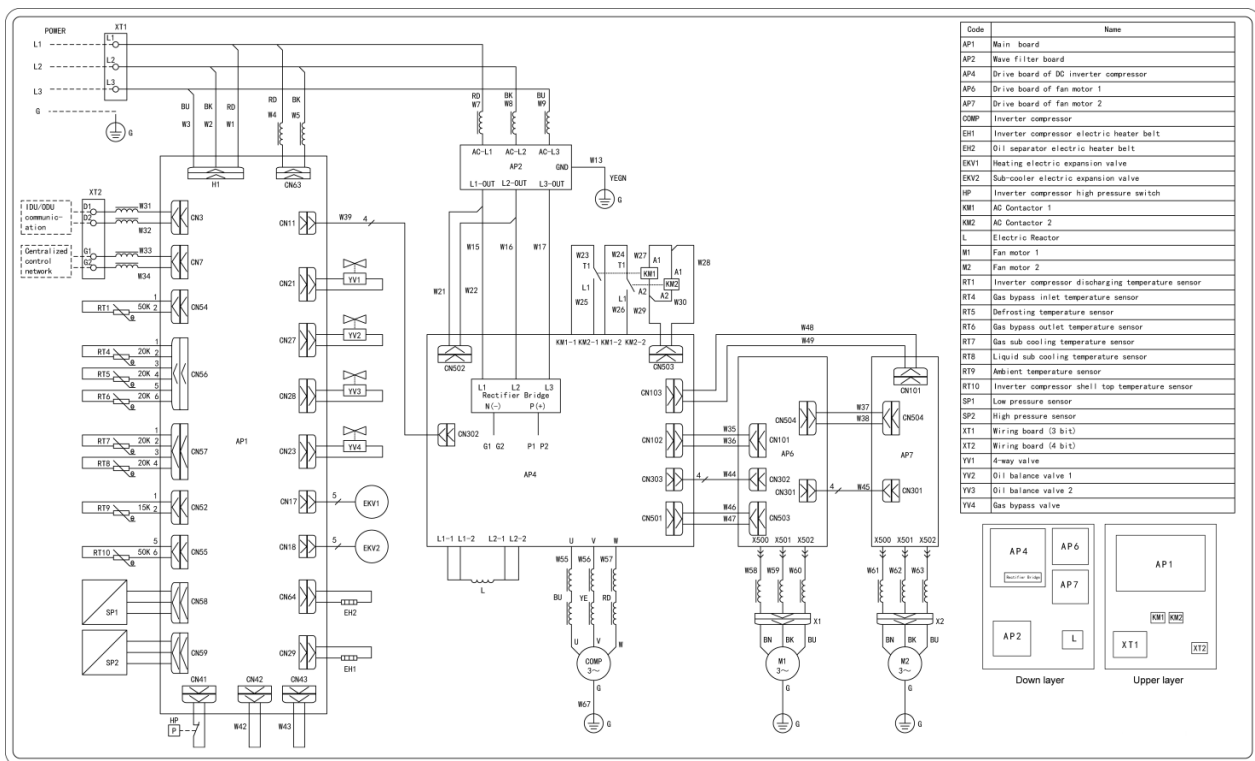



GMV-120WM/B-F (U)

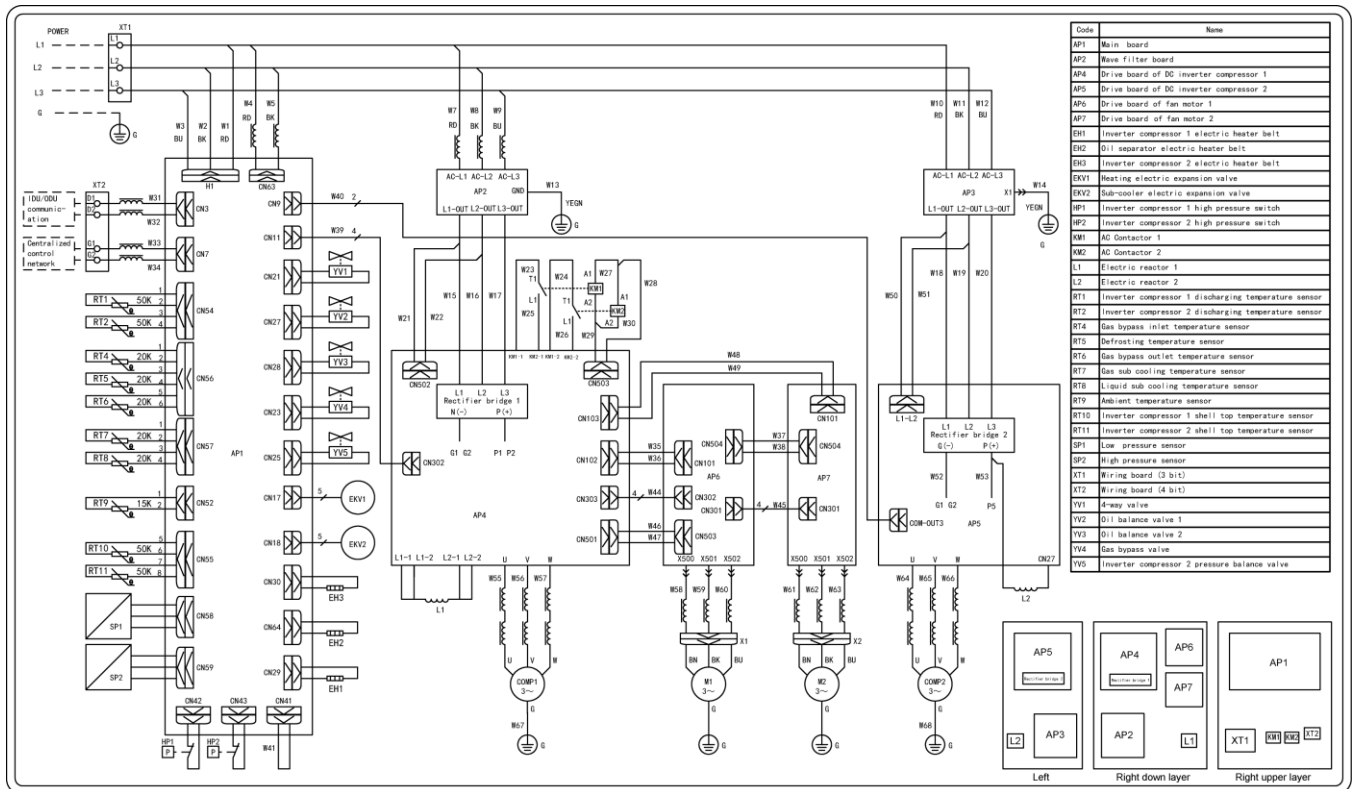

GMV-144WM/B1-F (U)

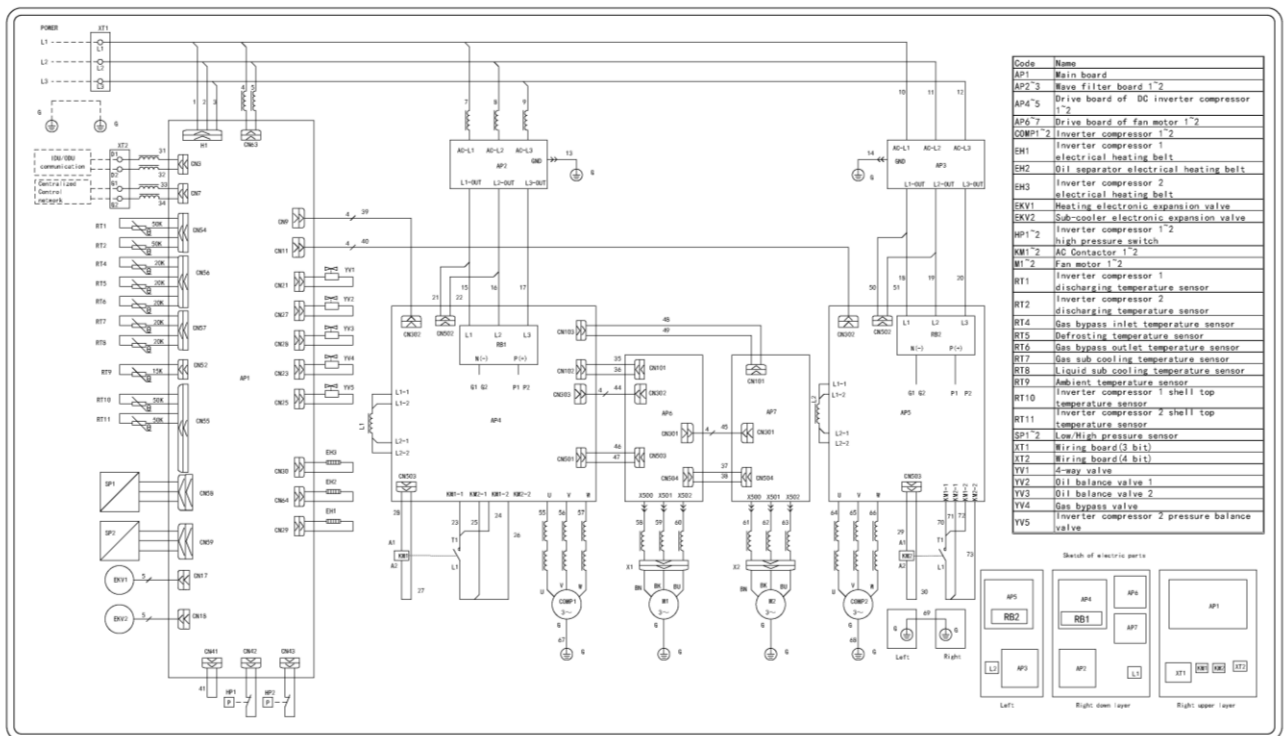

GMV-168WM/B1-F (U)

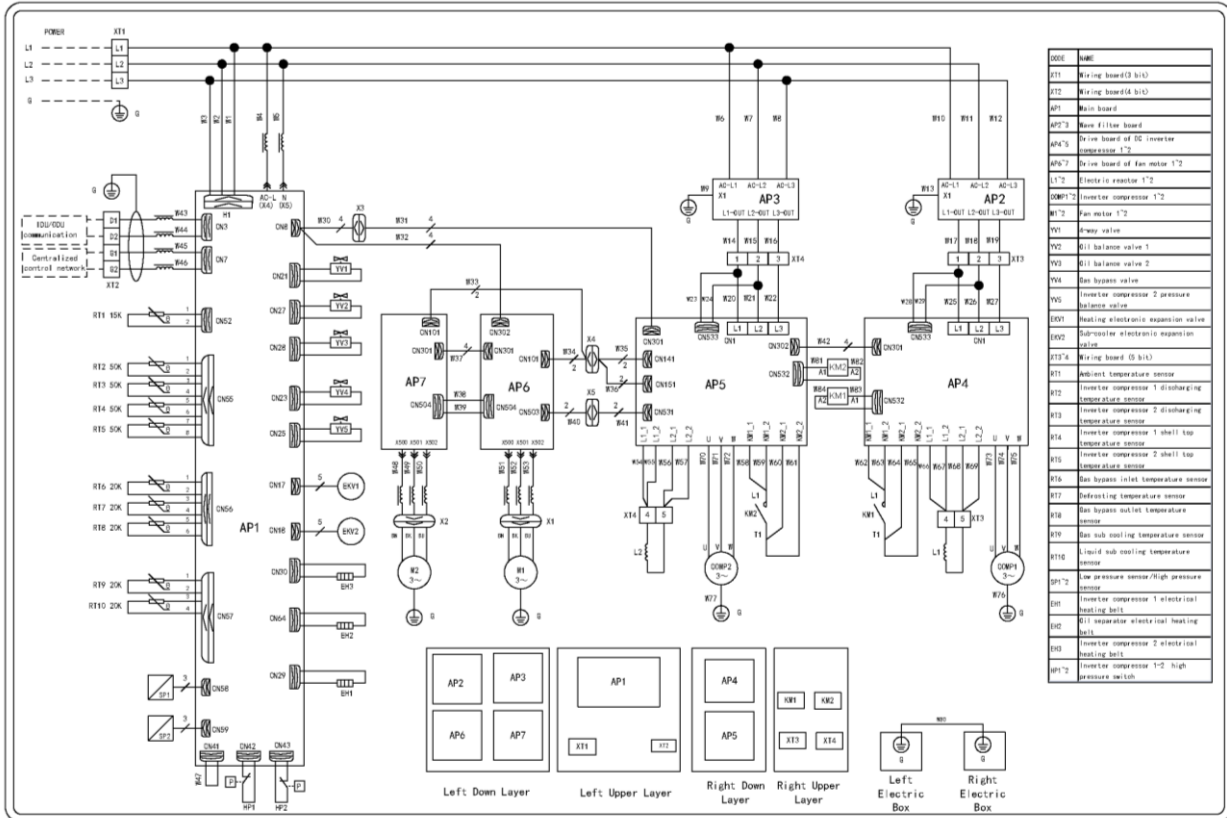

**NOTICE!** This drawing is just for reference; please always refer to the electric wiring stuck to the unit for actual wiring.

6.2 Circuit diagram of GMV-\*\*WM/B-U (U)

GMV-72WM/B-U (U)

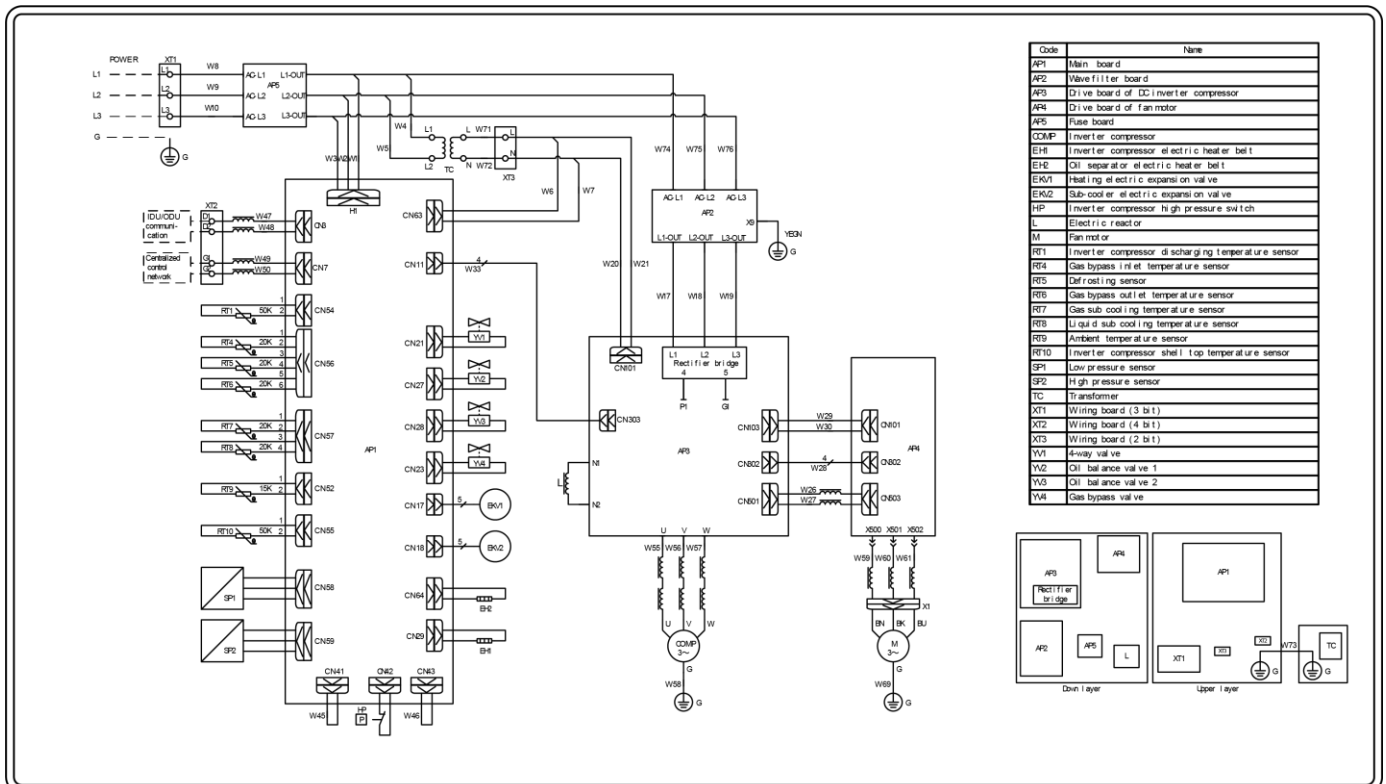

GMV-96WM/B-U (U)

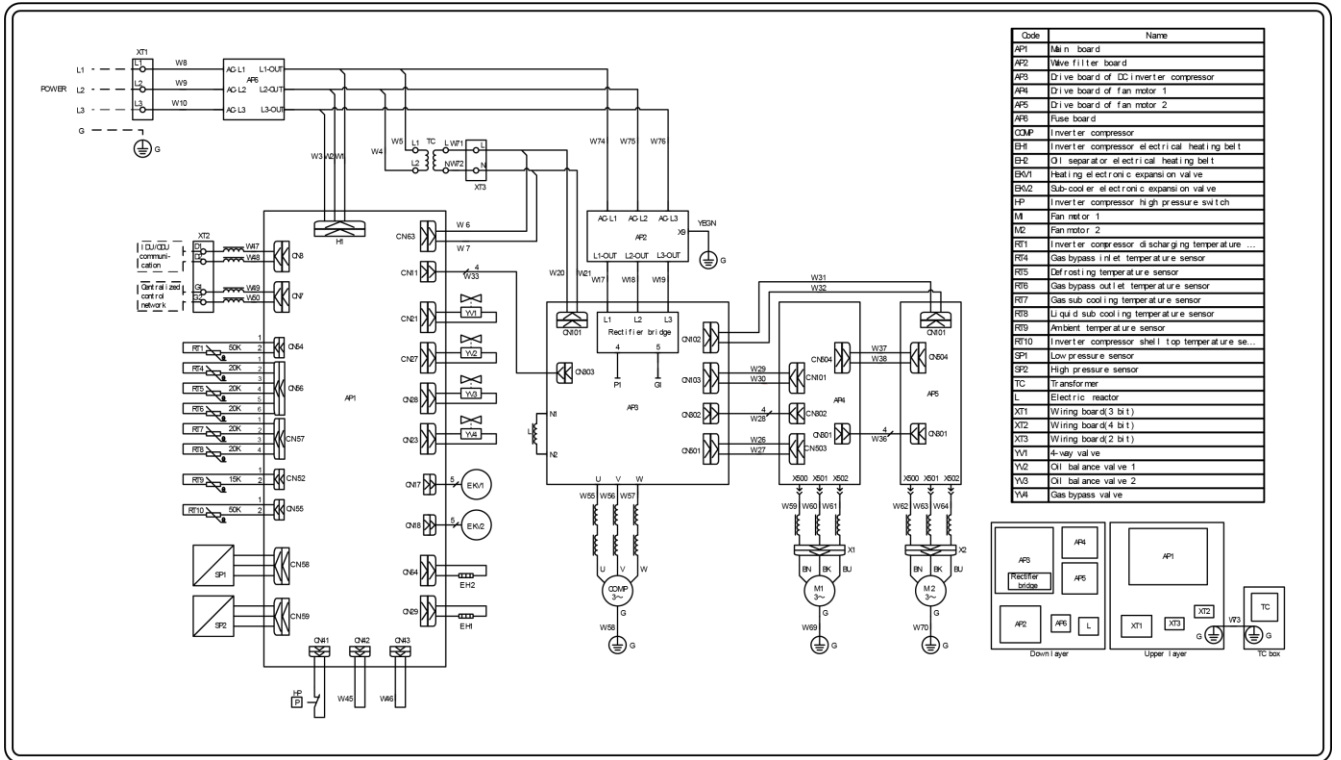

GMV-120WM/B-U (U)

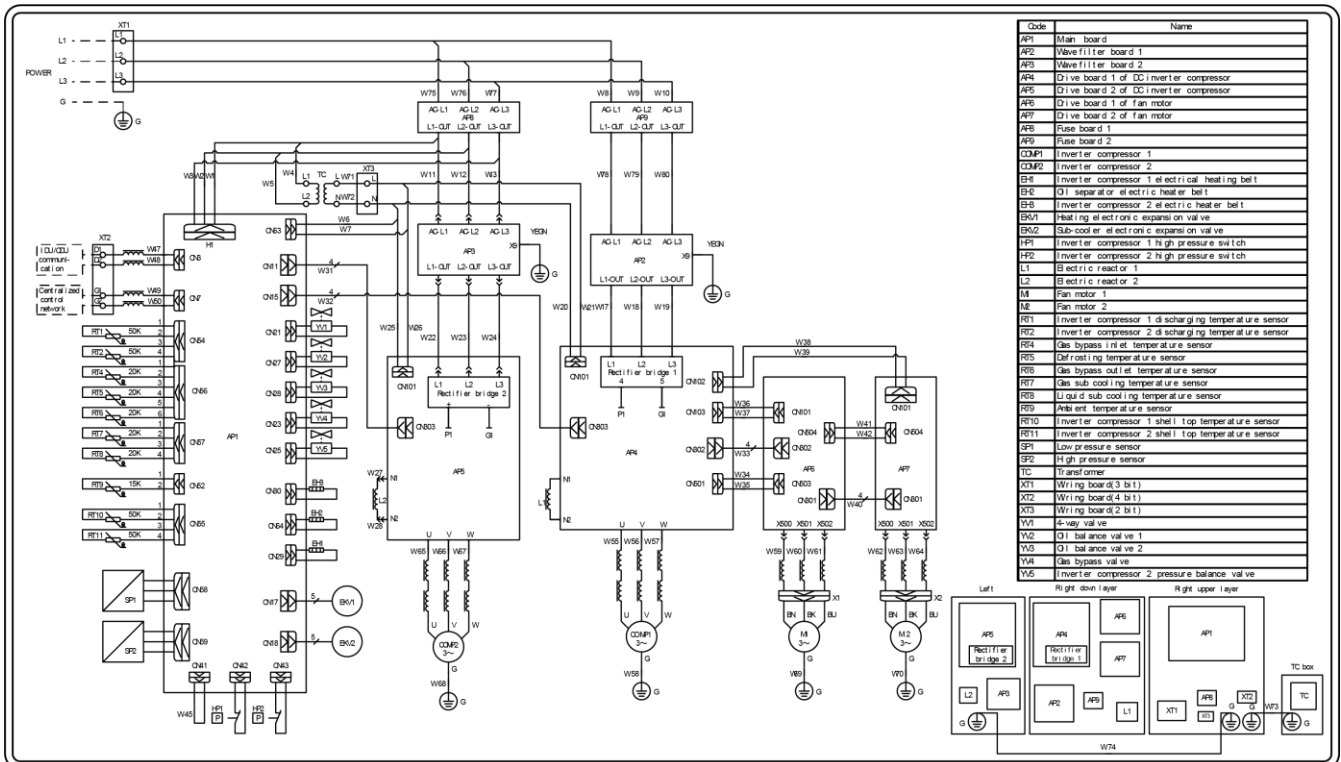

**NOTICE!** This drawing is just for reference; please always refer to the electric wiring stuck to the unit for actual wiring.

**WARNING**

When conducting maintenance based on above circuit diagrams, units must be power-off. Please strictly following the circuit diagrams when reconnecting the wires, otherwise, electric shock may occur.

## 7 UNIT OPERATING TEMPERATURE

Cooling	Ambient temperature: -5°C(23°F)~52°C(125.6°F)
Heating	Ambient temperature: -20°C (-4°F)~24°C (75.2°F)

In the case of a full fresh air conditioning IDU, the unit operating temperature is as follows:

Cooling	Ambient temperature: 16°C(60.8°F)~45°C(113°F)
Heating	Ambient temperature: -7°C (19.4°F)~16°C (60.8°F)

### CAUTION

- If unit operates out of the above range, it may not work stably and components may even be damaged.

# CHAPTER 2 INSTALLATION

## 1 ENGINEERING INSTALLATION PREPARATION

### 1.1 INSTALLATION SAFETY

Personnel and property safety are highly concerned during the entire installation process. Installation implementation must abide by relevant national safety regulations to ensure personnel and property safety.

All personnel involved in the installation must attend safety education courses and pass corresponding safety examinations before installation. Only qualified personnel can attend the installation. Relevant personnel must be held responsible for any violation of the regulation.

### 1.2 IMPORTANCE OF INSTALLATION ENGINEERING

VRF air conditioning systems use refrigerant, instead of other agent, to directly evaporate to carry out the system heat. High level of pipe cleanness and dryness is required in the system. Since various pipes need to be prepared and laid out onsite, carelessness or maloperation during installation may leave impurities, water, or dust inside refrigerant pipes. If the design fails to meet the requirement, various problems may occur in the system or even lead to system breakdown.

Problems that usually occur during installation are as follows:

No.	Installation Problem	Possible Consequence
1	Dust or impurities enter into the refrigeration system.	Pipes are more likely to be blocked; air conditioning performance is reduced; compressor wear is increased or even hinder the normal operation of the system and burn the compressor.
2	Nitrogen is not filled into the refrigerant pipe or insufficient Nitrogen is filled before welding.	Pipes are more likely to be blocked; air conditioning performance is reduced; compressor wear is increased or even hinder the normal operation of the system and burn the compressor.
3	The vacuum degree in the refrigerant pipe is insufficient.	The refrigeration performance is reduced. The system fails to keep normal operation due to frequent protection measures. When the problem getting serious, compressor and other major components can be damaged.
4	Water enters into the refrigeration system.	Copper plating may appear on the compressor and reduce the compressor efficiency with abnormal noise generated; failures may occur in the system due to ice plug.
5	The refrigerant pipe specifications do not meet the configuration requirements.	Smaller configuration specifications can increase the system pipe resistance and affect the cooling performance; larger configuration specifications are waste of materials and can also reduce the cooling performance.
6	Refrigerant pipe is blocked.	The cooling performance is reduced; in certain cases, it may cause long-term compressor operating under overheat conditions; the lubricating effect can be affected and the compressor may be burnt if impurities were mixed with the lubricating oil.
7	Refrigerant pipe exceeds the limit.	The loss in pipe is considerable and the unit energy efficiency decreases, which are harmful for long-term running of the system.
8	Incorrect amount of refrigerant is filled.	The system cannot correctly control the flow allocation; the compressor may be operating under over-heating environment or running when the refrigerant flows back to the compressor..
9	The refrigerant pipe leaks.	Insufficient refrigerant circulating in the system decreases the cooling performance of the air conditioner. Long-term operation under such circumstance may cause an overheating compressor or even damage the compressor.

No.	Installation Problem	Possible Consequence
10	Water drainage from the condensate water pipe is not smooth.	Residual water in IDUs can affect the normal operation of the system. The possible water leakage can damage the IDU's decoration.
11	The ratio of slop for condensate water pipe is insufficient or the condensate water pipe is incorrectly connected.	Reverse slop or inconsistent connection of condensate water pipe can hinder the smooth drainage and cause leakage of the IDU.
12	The air channel is improperly fixed.	The air channel will deform; vibration and noise occur during unit operating.
13	The guide vane of air channel is not reasonably manufactured.	Uneven air quantity allocation reduces the overall performance of the air conditioner.
14	The refrigerant pipe or condensate water pipe does not meet the insulation requirement.	Water can easily condensate and drip to damage the indoor decoration, or even trigger the protection mode of system due to overheating operation.
15	The installation space for IDU is insufficient.	Since there is a lack of space for maintenance and checking, indoor decoration might need to be damaged during such operation.
16	The IDU or the location of the air outlet or return air inlet is not designed reasonably.	The air outlet or return air inlet may be short-circuited, thus affecting the air conditioning performance.
17	The ODU is improperly installed.	The ODU is difficult to be maintained; unit exhaust is not smooth, which reduces the heat exchanging performance or even prevent the system from normal operation; in addition, the cold and hot air for heat exchange and the noise may annoy people in surrounding areas.
18	Power cables are incorrectly provided.	Unit components may be damaged and potential safety hazard may occur.
19	Control communication cables are incorrectly provided or improperly connected.	The normal communication in the system fails or the control over IDUs and ODUs turn in a mess.
20	Control communication cables are not properly protected.	The communication cables are short-circuited or disconnected, and the unit cannot be started up due to communication failure.

Understand the special requirement (if any) for unit installation before implementation to ensure installation quality. Relevant installers must have corresponding engineering construction qualifications.

Special type operators involved in the engineering implementation, such as welders, electricians, and refrigeration mechanics must have relevant operating licenses and are accredited with vocational qualification certification.

## 1.3 COOPERATION BETWEEN DIFFERENT PROFESSIONS

A quality installation of air conditioning engineering depends on careful organization and close cooperation between different professions such as architecture, structure, electric, water supply and drainage, fire-fighting, and decoration. Pipes must be laid in places away from any automatic spray head for fire-fighting, and must be reasonably arranged to ensure that the pipes fit the electric, luminaries, and decoration.

### 1.3.1 Requirements for cooperation with civil engineering

- (1) The riser should be installed in the air conditioning tube well, and the horizontal pipe should be placed in the ceiling, if possible.
- (2) A place should be reserved for the ODU base to prevent the waterproof layer or insulating layer on the roof from being damaged in later phase of installation.
- (3) At places on walls or floors where pipes need to go through, holes or casing should be preserved.

If the pipe needs to go through a bearing beam, a steel casing must be prepared.

### **1.3.2 Requirements for cooperation with decoration engineering**

The air conditioning installation should not damage the bearing structure or the decorative style. Air conditioning pipes should be laid out along the bottom of the beam as possible. If pipes meet one another at the same elevation, process based on the following principles:

- (1) Drain pipes enjoy the highest priority. Air ducts and pressure pipes should leave places for gravity pipes.
- (2) Air ducts and small pipes should leave places for major pipes.

### **1.3.3 Requirements for cooperation with electric**

After the capacity of air conditioning unit is determined, check the following aspects with relevant electric design personnel:

- (1) Whether the electrical load is designed based on the requirement of the air conditioning unit;
- (2) Whether the power cable and circuit breaker meet the unit requirement and abide by relevant national safety regulations;
- (3) Whether the regional power supply quality (including voltage fluctuation and interference noise) meet the international requirement;
- (4) Any nonconformity must be resolved through coordination.

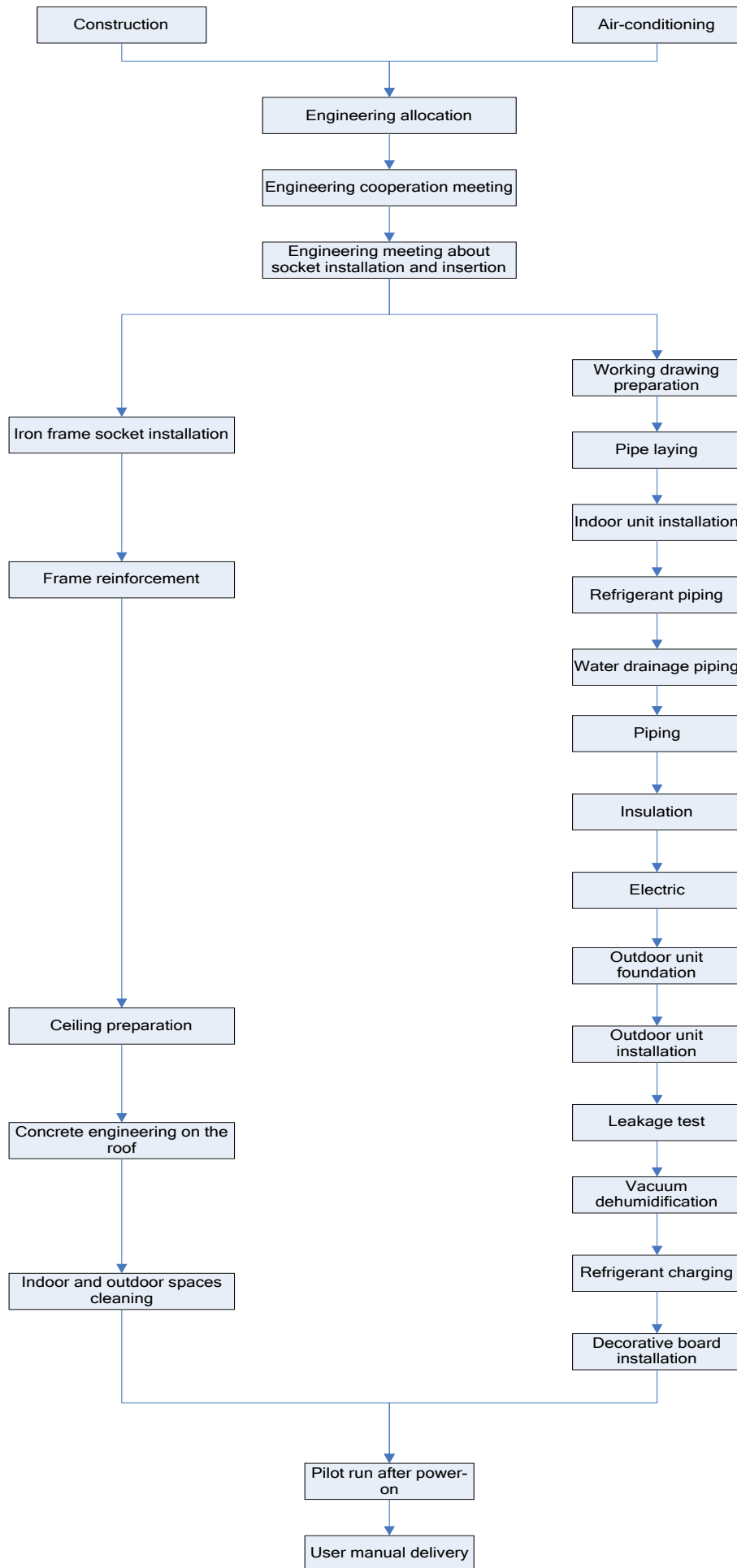



## 1.4 ONSITE REVIEW OF DESIGN DRAWING

Installation personnel must carefully read and understand the design scheme and drawings provided by engineering designers, and prepare detailed and feasible construction organization design after reviewing the onsite status.

The following aspects of working drawing must be reviewed:

- 1.The loads of indoor and ODUs must match. The gross rated capacity of the IDU should be set to a value that is 50% to 135% of the rated capacity of the ODU. In actual conditions, if the capacity of concurrently operating IDUs exceeds 100% of the rated capacity of the ODU, the air conditioning system fails to meet the requirement. Note: Configuration in excess of the capacity of the IDUs can affect the comfort for users. The more the excess is, the lower the adjustment capacity of an air conditioning unit will be. When the capacity exceeds 135% of the configured value, the system reliability can be affected. Therefore, relevant regulations on capacity limit must be strictly followed.
- 2.The difference of level between an ODU and an IDU, and that between IDUs must be set within the designed range.
- 3.Pipe bend for trapped oil is required for air pipe riser in the unit to ensure normal circulation in the unit lubricating system.
- 4.The pipe diameter and manifold type in the cooling system must meet relevant technical specifications.
- 5.The drainage method of unit condensate water must be reasonable; the pipeline slope must follow the design requirement of unit.
- 6.The air duct direction and air flow are reasonably organized.
- 7.The configuration specifications, type, and control method of power cables should meet the design requirement of unit.
- 8.The arrangement, total length, and control method of control line should meet the design requirement of unit.

**NOTICE!** Engineering construction personnel must strictly abide by the design drawings. If any design cannot be implemented during construction and needs to be modified, contact the designer first for approval and prepare a written document, that is, the design modification record.

# 1.5 CONSTRUCTION ORGANIZATION PROCESS

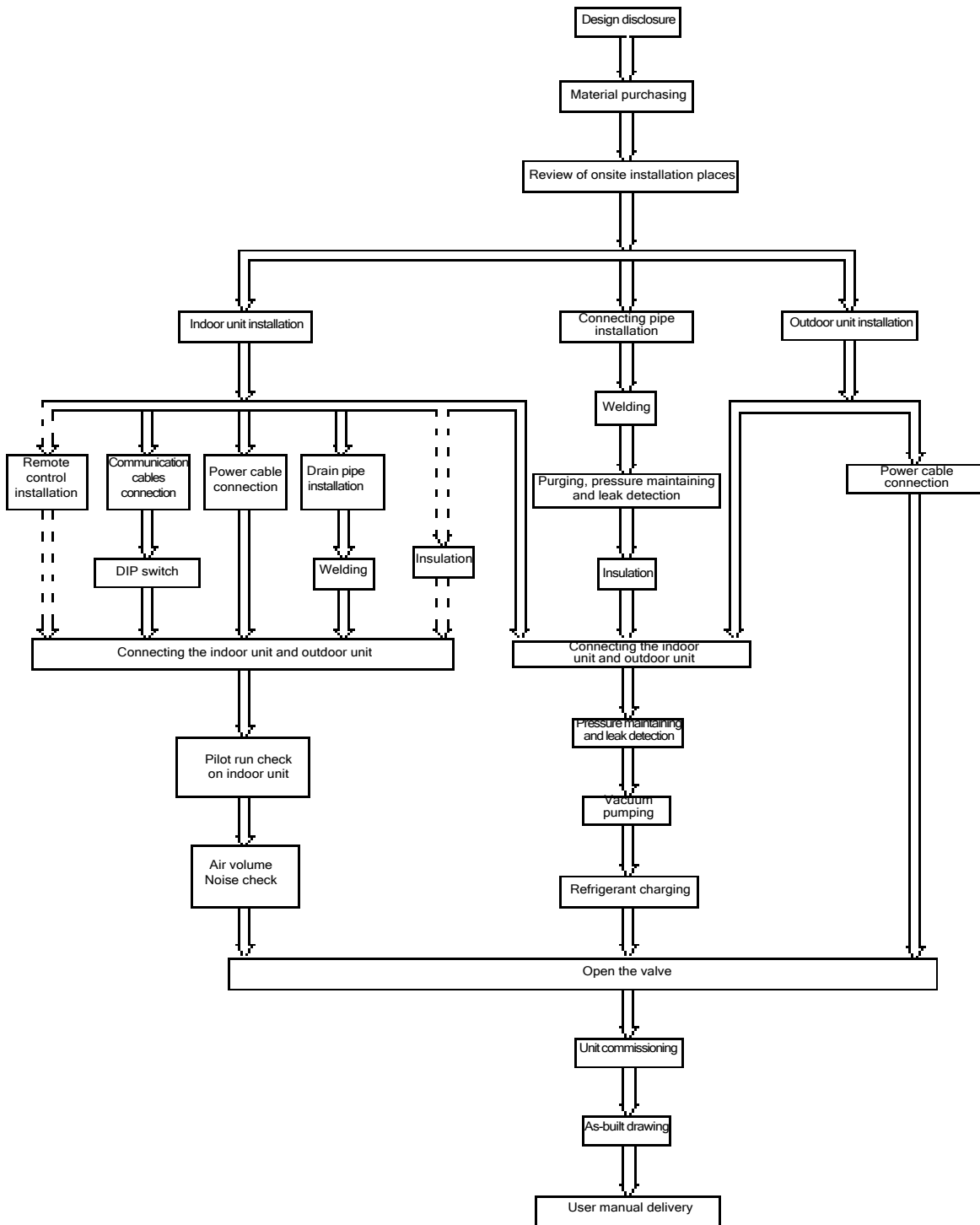

Above process is a general operation process, which can be adjusted in practice according to local requirements.

## 2 MATERIAL SELECTION

### 2.1 REQUIREMENT FOR SELECTING CONSTRUCTION MATERIALS

The materials, equipment and instruments used during air conditioning engineering construction must have certifications and test reports.

Products with fireproof requirements must be provided with fireproof inspection certificates and must meet national and relevant compulsory standards.

If environmentally-friendly materials are to be used as required by customers, all such materials must meet national environmental protection requirement and be provided with relevant certificates.

### 2.2 REQUIREMENT FOR SELECTING MAJOR MATERIALS

#### 2.2.1 Copper pipe

- a. Material requirement: Dephosphorization drawing copper pipe for air conditioners
- b. Appearance requirement: The inner and outer surface of pipe should be smooth without pinhole, crack, peeling, blister, inclusion, copper powder, carbon deposition, rust, dirt or severe oxide film, and without obvious scratch, pit, spot and other defects.
- c. Test report: Certifications and quality test reports must be provided.
- d. The tensile strength must be at least 240 kgf/mm<sup>2</sup>.
- e. Specifications requirement

R410A Refrigerant System		
Outer Diameter mm(in.)	Wall Thickness mm(in.)	Type
Φ6.35(1/4)	≥0.8(1/32)	O
Φ9.52(3/8)	≥0.8(1/32)	O
Φ12.7(1/2)	≥0.8(1/32)	O
Φ15.9(5/8)	≥1.0(3/76)	O
Φ19.05(3/4)	≥1.0(3/76)	1/2H
Φ22.2(7/8)	≥1.2(1/21)	1/2H
Φ28.6(1-1/8)	≥1.2(1/21)	1/2H
Φ34.9(1-3/8)	≥1.3(2/39)	1/2H
Φ41.3(1-5/8)	≥1.5(1/17)	1/2H

- f. After the inner part of the copper pipe is cleaned and dried, the inlet and outlet must be sealed tightly by using pipe caps, plugs or adhesive tapes.

#### 2.2.2 Condensate water pipe

- a. Pipes that can be used for air conditioner drainage include: water supplying UPVC pipe, PP-R pipe, PP-C pipe, and HDG steel pipe.
- b. All relevant certificates and quality test reports are provided.
- c. Requirements for specifications and wall thickness
- d. Water supplying UPVC pipe: Φ32mm×2mm, Φ40mm×2mm, Φ50mm×2.5mm;

e. HDG steel pipe:  $\Phi 25\text{mm} \times 3.25\text{mm}$ ,  $\Phi 32\text{mm} \times 3.25\text{mm}$ ,  $\Phi 40\text{mm} \times 3.5\text{mm}$ ,  $\Phi 50\text{mm} \times 3.5\text{mm}$ .

### 2.2.3 Insulation material

- a. Rubber foam insulation material;
- b. Flame retardancy level: B1 or higher;
- c. Refractoriness: at least  $120^{\circ}\text{C}$ ;
- d. The insulation thickness of condensate water pipe: at least 10 mm;
- e. When the diameter of copper pipe is equal to or greater than  $\Phi 15.9$  mm, the thickness of insulation material should be at least 20 mm; when the diameter of copper pipe is less than 15.9 mm, the thickness of insulation material should be at least 15 mm.

### 2.2.4 Communication cable and control cable

For air conditioning units installed in places with strong electromagnetic interference, shielded wire must be used as the communication cables of the IDU and wired controller, and shielded twisted pairs must be used as the communication cables between IDUs and between the IDU and ODU.

(1) Selection for the communication cables of outdoor unit and indoor unit:

Material Type	Total Length L(m(feet)) of Communication Cable between IDU Unit and IDU (ODU ) Unit m(feet)	Wire size	Remarks
Light/Ordinary polyvinyl chloride sheathed cord.	$L \leq 1000(3280-5/6)$	$\geq 2 \times \text{AWG}18$	<ol style="list-style-type: none"> <li>1. If the wire diameter is enlarged to <math>2 \times \text{AWG}16</math>, the total communication length can reach 1500m(4921-1/4feet).</li> <li>2. The cord shall be Circular cord (the cores shall be twisted together).</li> <li>3. If unit is installed in places with intense magnetic field or strong interference, it is necessary to use shielded wire.</li> </ol>

(2) Selection for the communication cable between the indoor unit and wired controller:

Material type	Total length of communication line between IDU unit and wired controller L (m(feet))	Wire size	Remarks
Light/Ordinary polyvinyl chloride sheathed cord.	$L \leq 250(820-1/5)$	$2 \times \text{AWG}18 \sim 2 \times \text{AWG}16$	<ol style="list-style-type: none"> <li>1. Total length of communication line can't exceed 250m(820-1/5feet).</li> <li>2. The cord shall be Circular cord (the cores shall be twisted together).</li> <li>3. If unit is installed in places with intense magnetic field or strong interference, it is necessary to use shielded wire.</li> </ol>

**NOTE:** All of the selected communication wire must be consistent with local laws and regulations.

### 2.2.5 Power cable

Only copper conductors can be used as power cables. The copper conductors must meet relevant national standard and satisfy the carrying capacity of unit.

## 2.2.6 Other requirements

Properties of the above-mentioned materials and the rest of materials that are used for the construction and installation must comply with local rules and regulations.

### CAUTION

- Wall thickness of copper pipe shall be consistent with above requirements and the design operating pressure shall not be lower than 3.8MPa (551psi). But if local authority has a higher requirement, please design and construct according to local safety standards.
- Materials of communication cable shall be consistent with above requirements. If there is conflict between these requirements and local relevant standards, please contact the corresponding distributor and confirm it with headquarter.
- The parallel distance between communication cable and strong current line shall be above 200mm. Communication cord must not cross with the strong current line.

# 3 INSTALLATION SPACE REQUIREMENT

## 3.1 PLACE SELECTION FOR INSTALLING ODU

The widely-used VRF units are applicable for various scenarios. In residential areas, especially in rooms where elderly and infants live, a higher refrigerating performance and noise control is required. Therefore, the ODU with excellent capacity and low noise is preferred; in addition, ODU should be installed in outdoor spaces instead of in bedrooms, studies or meeting rooms. In commercial areas, ODU should be installed far away from offices.

## 3.2 ODU DIMENSIONS AND INSTALLATION HOLE SIZE

External and installation dimensions of GMV-72WM/B-F (U) and GMV-72WM/B-U (U):

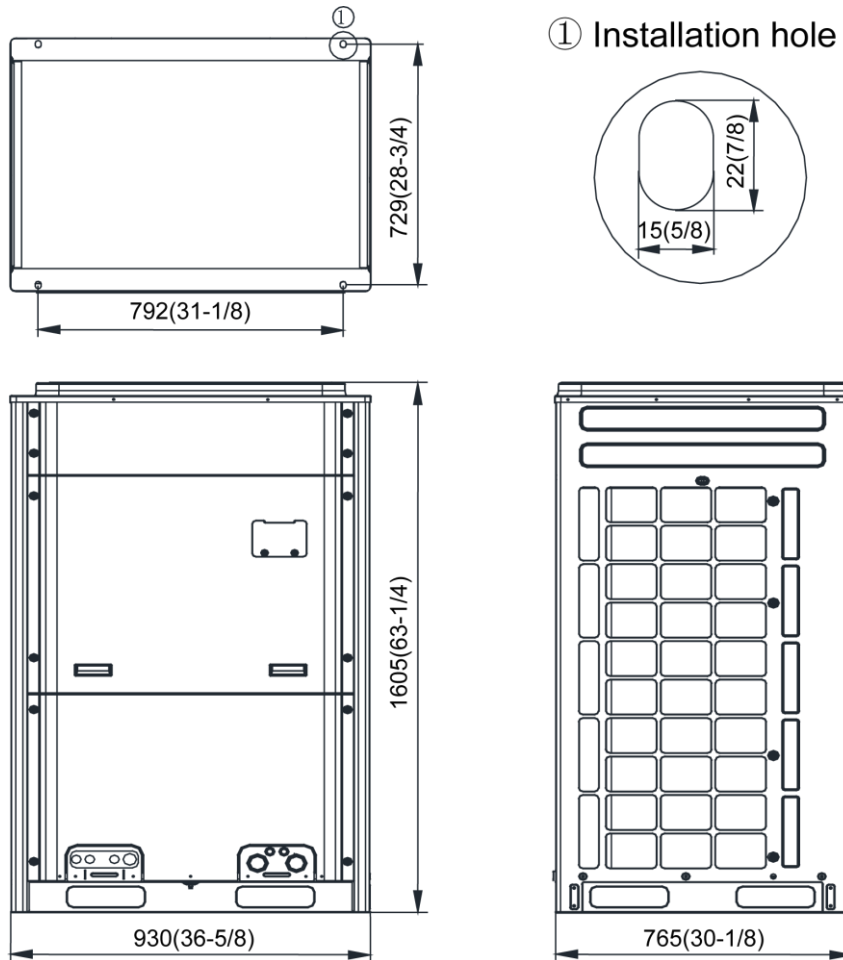

External and installation dimensions of GMV-96WM/B-F (U), GMV-96WM/B-U (U), GMV-120WM/B-F (U) / GMV-120WM/B-U (U) and GMV-144WM/B1-F (U):

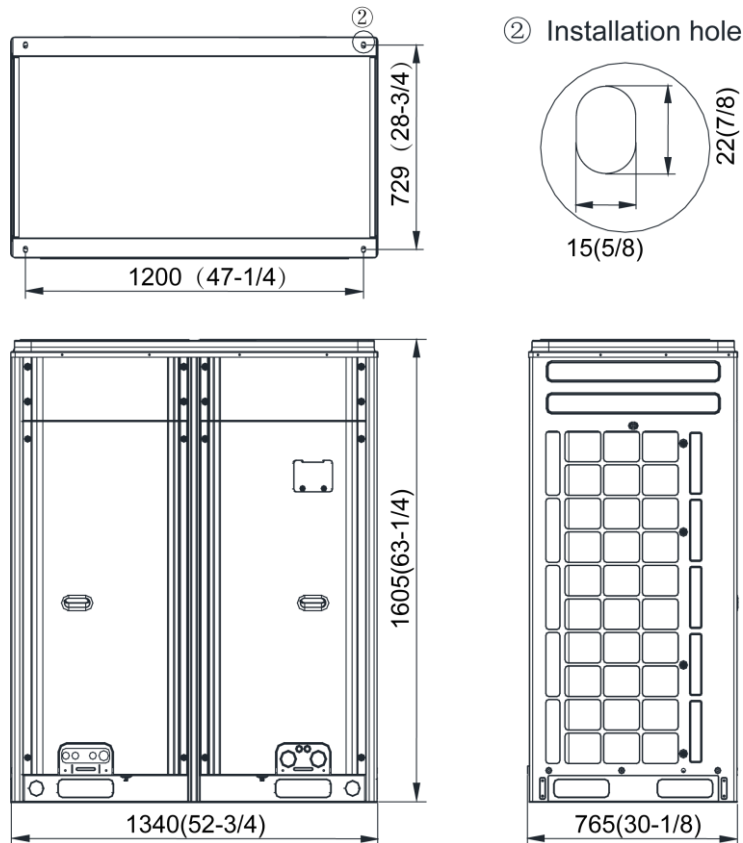

External and installation dimensions of GMV-168WM/B1-F (U):

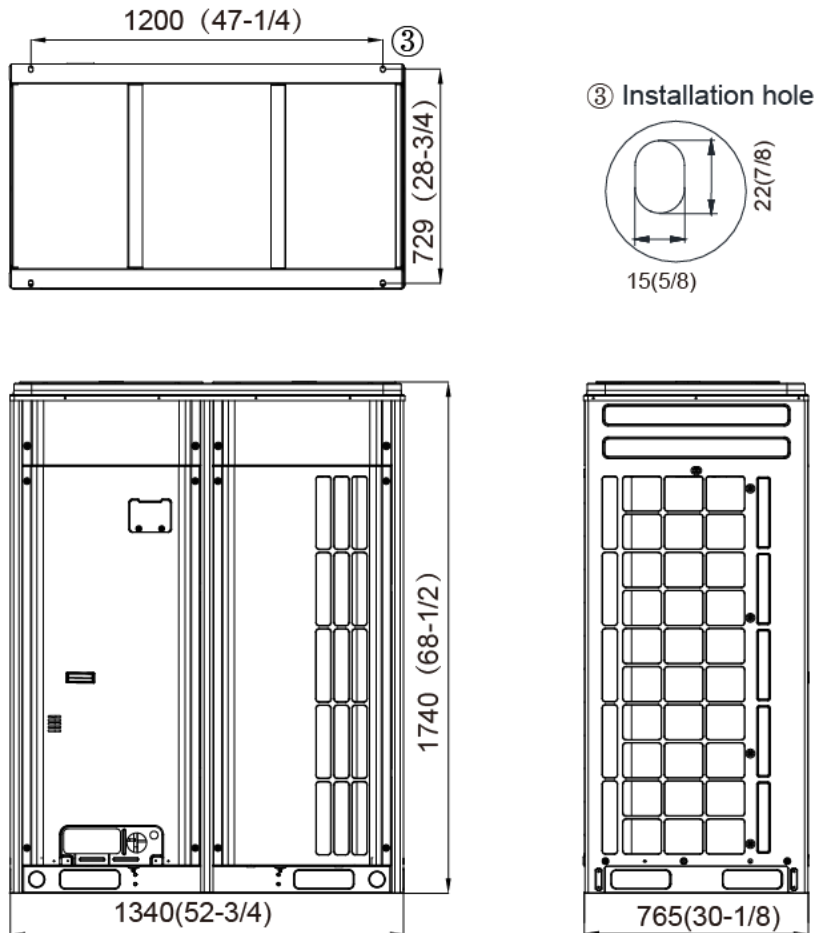

### 3.3 INSTALLATION SPACE REQUIREMENT FOR ODU

1. If all sides of the ODU (including the top) are surrounded by walls, process according to the following requirements for installation space:

(1) Installation space requirements for the single-module unit

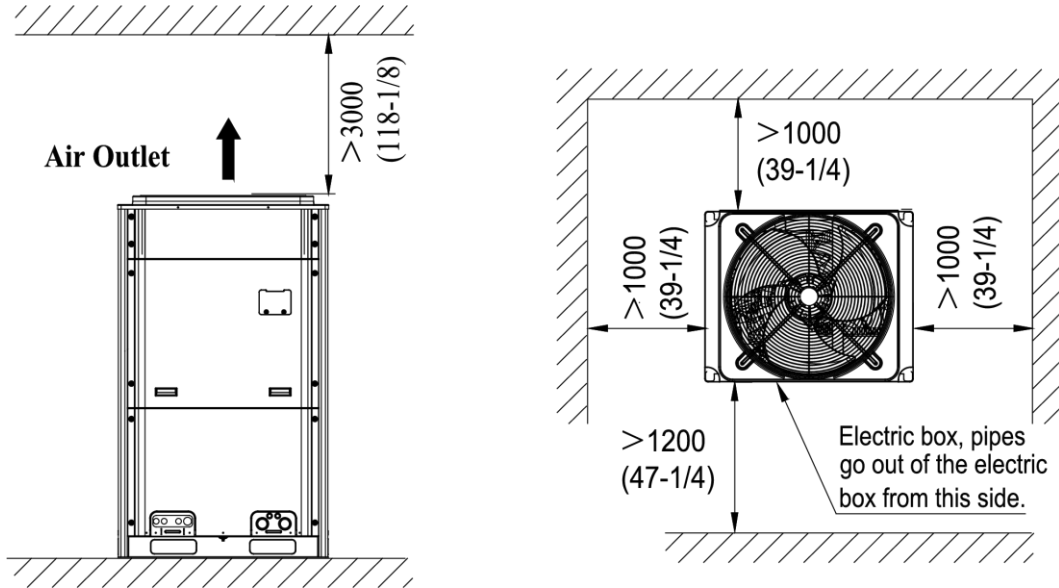

(2) Installation space requirements for the dual-module unit

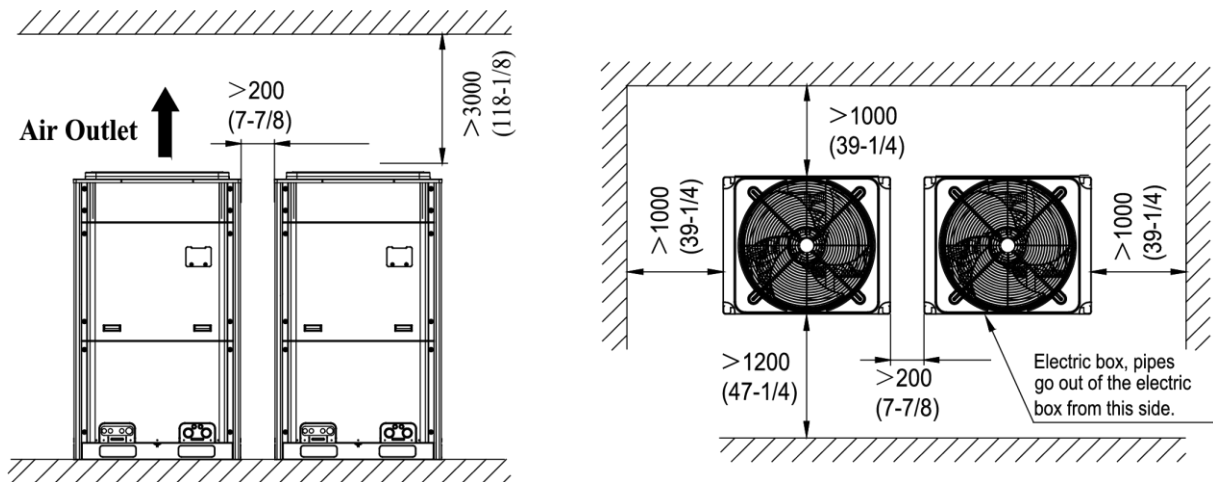



(3) Installation space requirements for triple-module unit

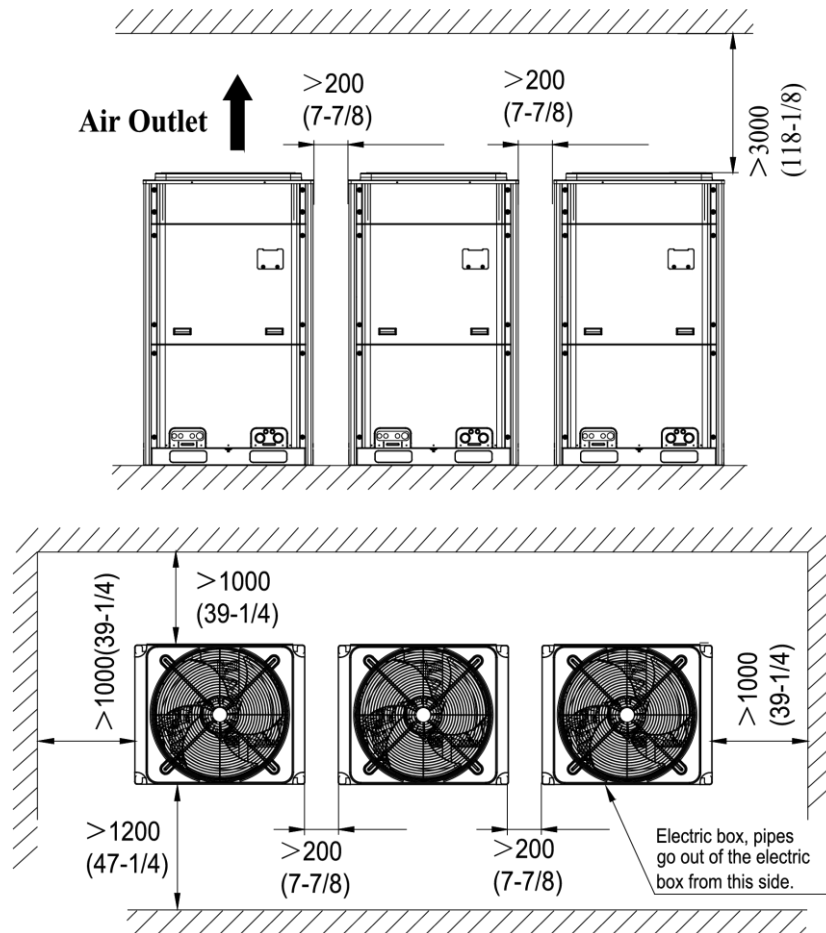

2. When there is wall (or similar obstruction) above the unit, keep the distance between the unit top and the wall at least 3000mm (118-1/8in.) or above. When the unit is located in a totally open space with no obstructions in four directions, keep the distance between the unit top and wall at least 1500mm (59in.) or above (See Fig.1). When space is limited within 1500mm (59in.) or the unit is not set in an open space, air outlet pipe is required to be installed in order to keep good ventilation (See Fig.2).

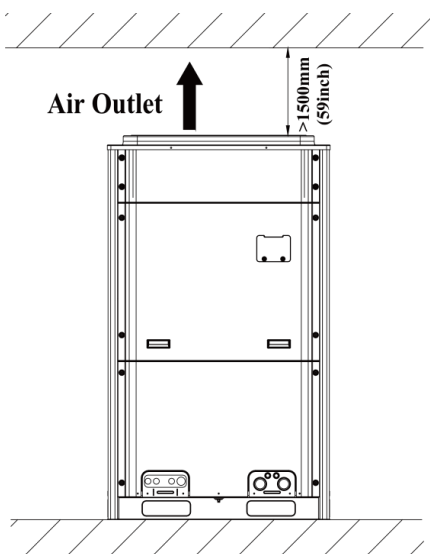

Fig.1

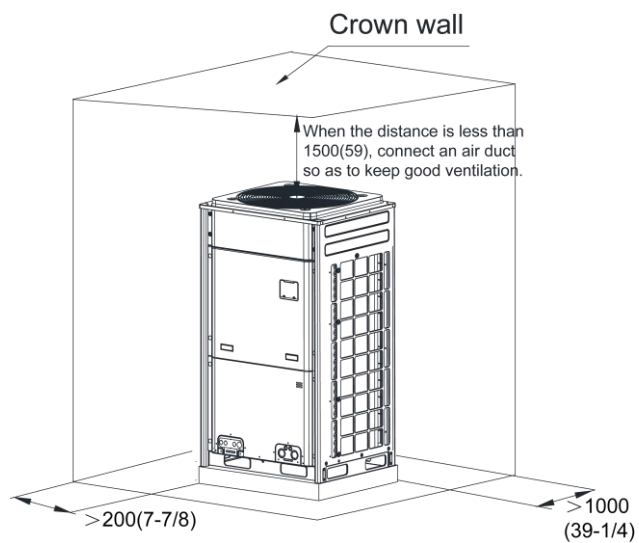
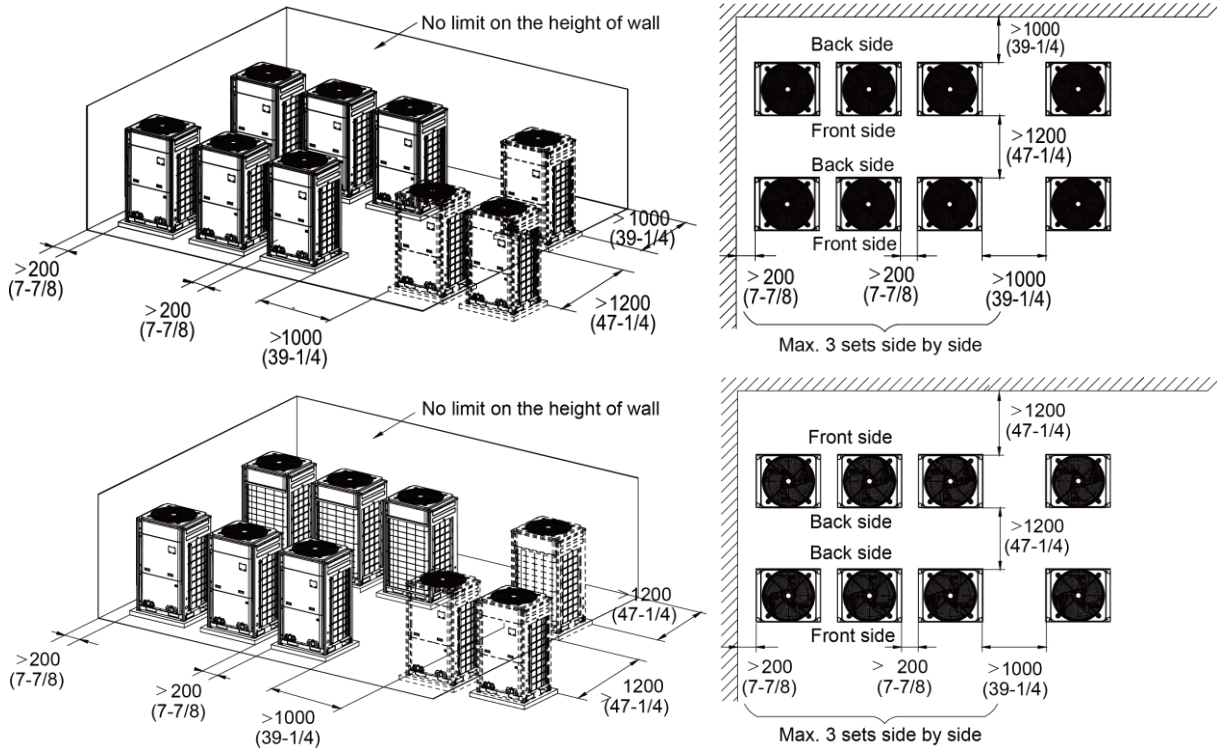

Fig.2

**Space dimension for multiple-module unit**

For keeping good ventilation, make sure there is no obstruction above the unit.

When the unit is located at a half-open space (front and left/right side is open), install the unit as per the same or opposite direction.



3. Considering the seasonal wind in outdoor unit installation

Anti-monsoon installation requirement for unit not connecting exhaust duct

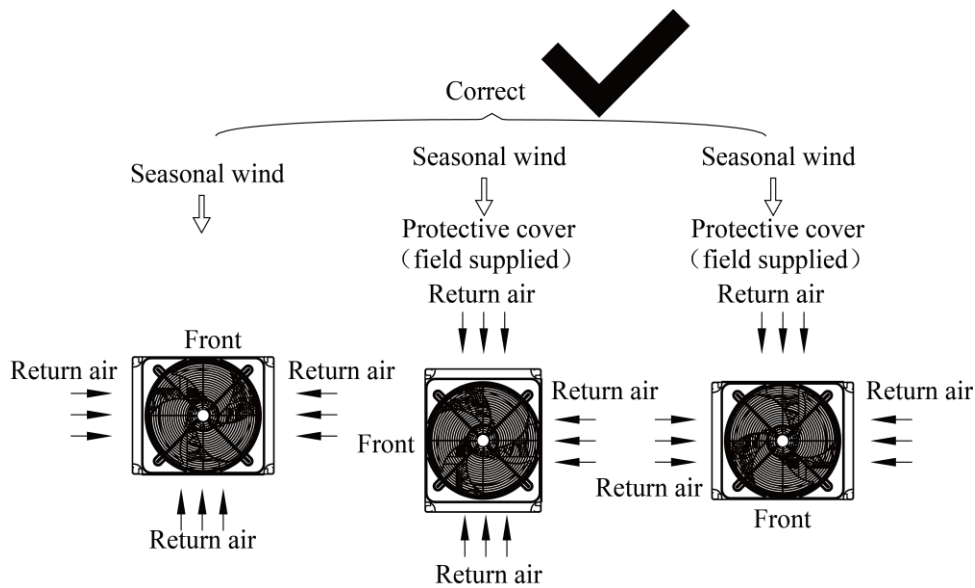

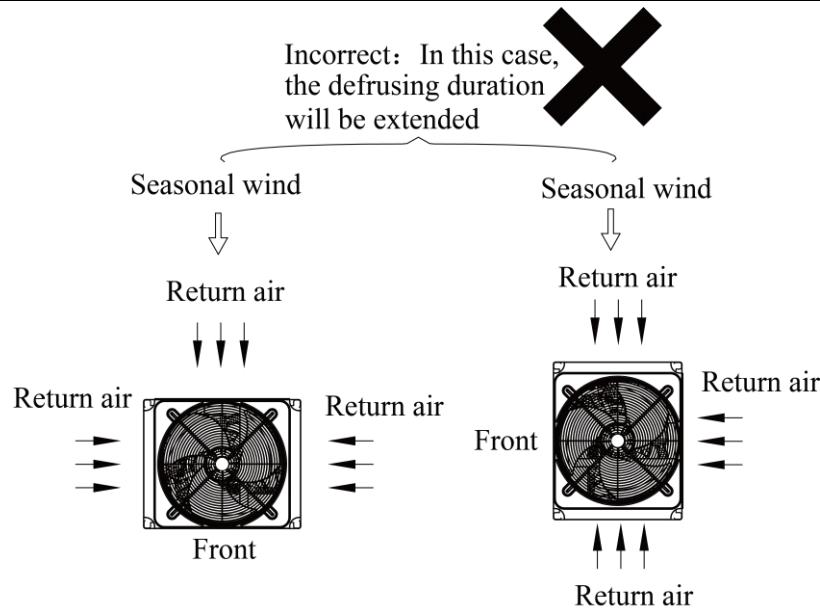

Anti-monsoon installation requirement for unit connecting exhaust duct

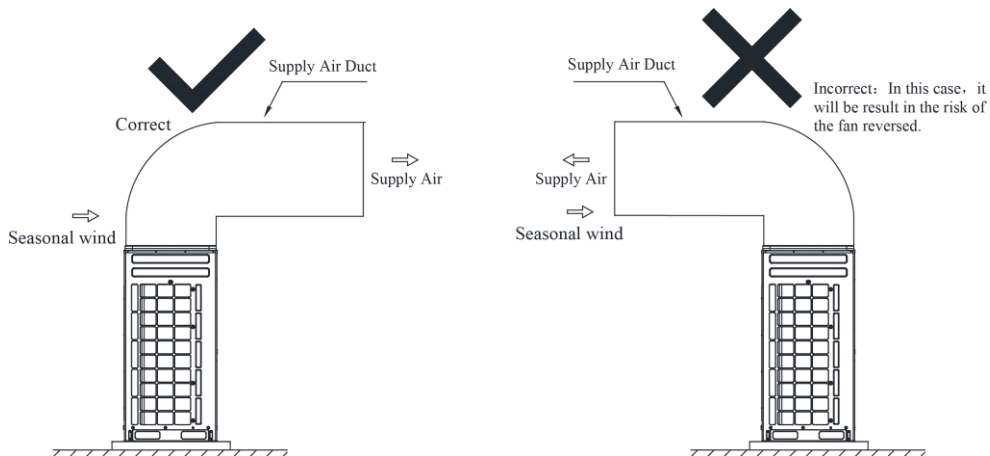

4. Considering snow in outdoor unit installation

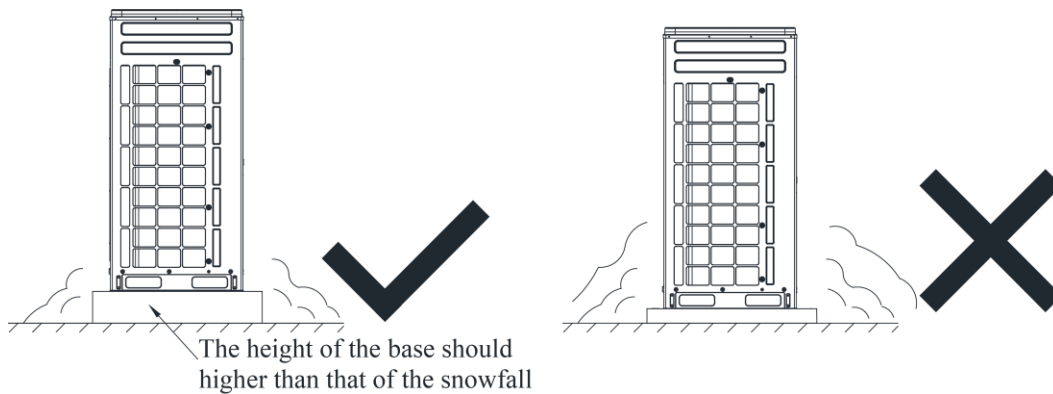

5. During the installation of the ODU, induced and exhaust pipes must be connected. In addition, the aperture opening rate of shutters must be at least 80%, and the angle between the shutters and the horizontal plane should be less than 20°. Requirements for installing exhaust air duct are as follows:

(1) Basic requirement for connecting an ODU to static pressure ventilating duct

When an ODU needs to be connected to the static pressure ventilating duct, the ventilating duct must be reasonably designed. The pressure loss caused by the ventilating duct must be calculated. In addition, a proper type of ventilating duct is necessary. To connect the static pressure ventilating duct to the ODU, three basic parts are required: 1) ODU; 2) canvas; and 3) steel-plate ventilating duct. The ODU

must be interconnected with the ventilating duct through canvas to prevent abnormal vibration and noise generated by the steel-plate ventilating duct. The joint part must be tightly sealed with tin foil to avoid air leakage.

(2) Preparations for connecting an ODU to static pressure ventilating duct

- 1) The ODU is installed properly based on the unit installation requirement.
- 2) The steel-plate ventilating duct is designed based on the unit and engineering requirement, and is installed properly according to the engineering standards.
- 3) Based on the unit dimensions and the size of steel-plate ventilating duct, prepare materials such as canvas casing, tin foil, steel bar and tapping screw, as well as tools such as hand-operated electric drill, air screw driver and screwdriver.

(3) Basic operation of connecting an ODU to static pressure ventilating duct

Two methods are available to connect an ODU to static pressure ventilating duct.

**Method 1**

- 1) Install the ODU (2) and steel-plate ventilating duct (1). Use an air screw driver or screwdriver to unfasten the tapping screws that fixing the top case component (3), and then remove the top case component. Take out the grille from the top of the top case component and leave the top case.
- 2) Put the canvas casing inside out (4). Cover one end of the canvas casing over the unit
- 3) Downward until the canvas end face is aligned with the unit or a bit higher than the top of the unit. Then, put the top case back (3) and tightly press the canvas casing (4). Use tapping screws to fix the top case onto the unit (3).
- 4) Pull up the canvas casing reversely (4) and use the steel bar (5) to press the canvas
- 5) Casing tightly onto the counter flange of the steel-plate ventilating duct (1). Use a hand-operated electric drill to drill holes and fasten the parts by using tapping screws.
- 6) Use the tin foil to seal the joints and check the joints' reliability.

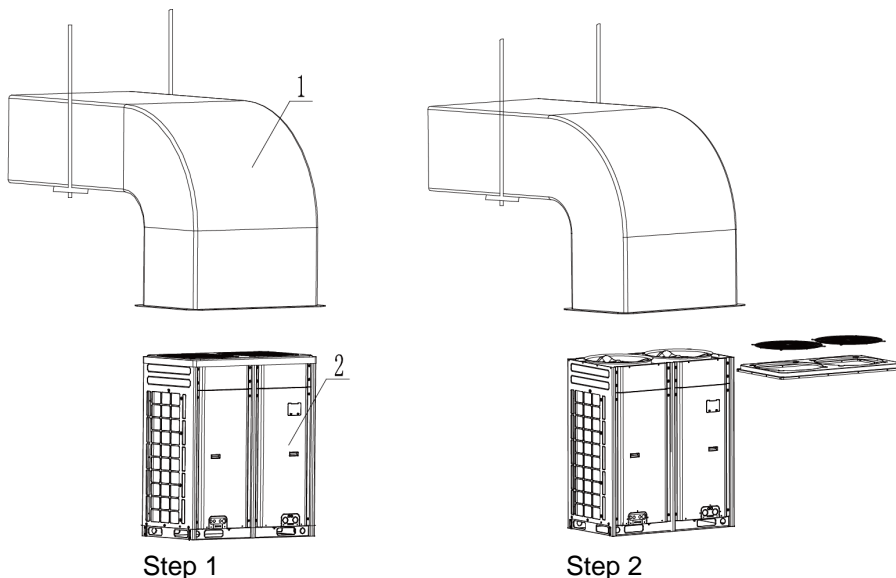

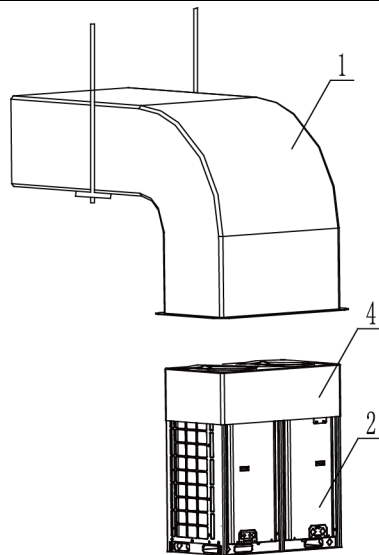

Step 3

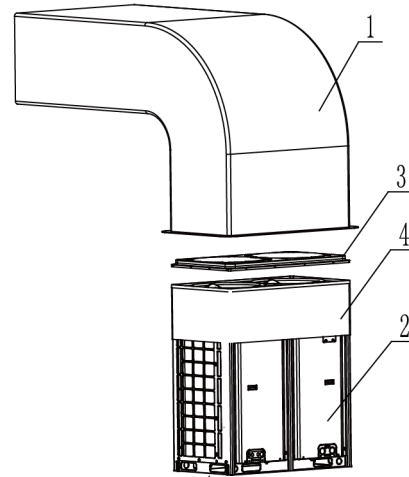

Step 4

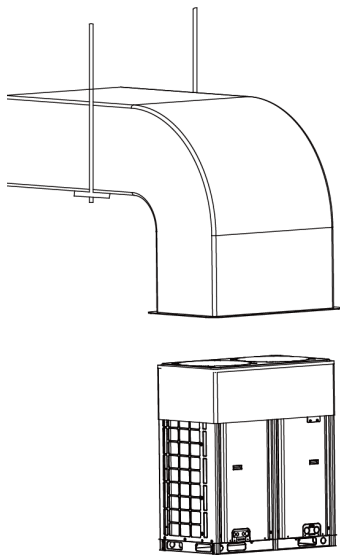

Step 5

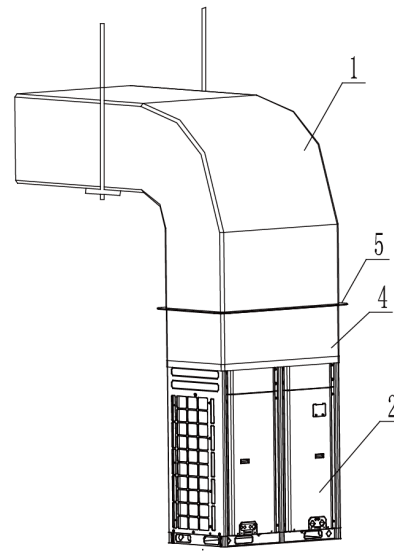

Step 6

### Method 2

- 1) Install the ODU (2) and steel-plate ventilating duct (1). Take out the grille from the top of the top case component. Use the prepared canvas casing inside out (4) to cover the surroundings over the top of the unit. Keep the top of canvas casing (4) 30 to 50 mm higher over the top of the unit.
- 2) Use a steel bar to press tightly the canvas casing (4) around the top case of the unit. Use a hand-operated electric drill to drill holes and fasten the canvas casing onto the unit through steel bar by using tapping screws.
- 3) Pull up the canvas casing reversely and use the steel bar to press the canvas casing tightly onto the counter flange of the steel-plate ventilating duct. Use a hand-operated electric drill to drill holes and fasten the parts by using tapping screws.
- 4) Use the tin foil to seal the joints and check the joints' reliability.

**NOTE:** Remove the grille on the top case when connecting an ODU to static pressure ventilating duct; otherwise, the air volume, especially the unit operating performance will be affected. For method 2, since drills are required on the top case, the powder coated protective layer on the top case will be damaged. As a result, the anti-corrosion performance of the unit top case will be reduced.

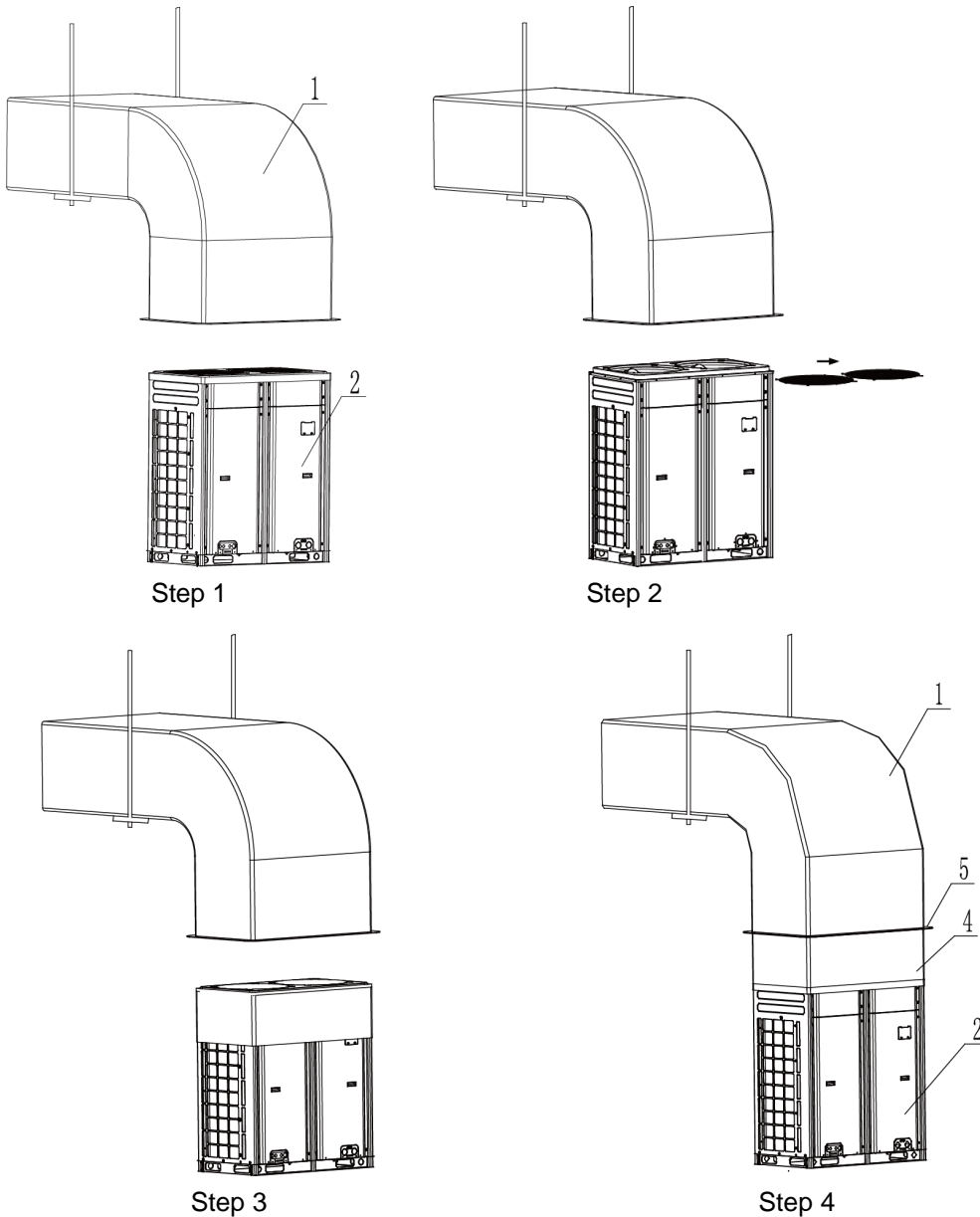

6. When the effective area of air intake is less than 70% of the total air intake area of all ODUs, an induced draft fan is also required. The total air input of induced draft fan should be no less than 80% of the total supply air rate.

## ▲ CAUTION

### **Be very careful while carrying the product.**

- Do not have only one person carry product if it is more than 20kg (44lbs).
- PP bands are used to pack some products. Do not use them as a mean for transportation because they are dangerous.
- Do not touch heat exchanger fins with your bare hands. Otherwise you may get a cut in your hands.
- Tear plastic packaging bag and scrap it so that children cannot play with it. Otherwise plastic packaging bag may suffocate children to death.
- When carrying in Outdoor Unit, be sure to support it at four points. Carrying in and lifting with

3-point support may make Outdoor Unit unstable, resulting in a fall.

- Use 2 belts of at least 3m (26.2ft) long.
- Place extra cloth or boards in the locations where the casing comes in contact with the sling to prevent damage.
- Hoist the unit making sure it is being lifted at its center of gravity.

## 4 REQUIREMENTS ON FOUNDATION INSTALLATION

### 4.1 ODU FOUNDATION

The concrete foundation of the ODU must be strong enough. Ensure that the drainage is smooth and that the ground drainage or floor drainage is not affected.

Requirements on the concrete foundation are as follows:

- (1) The concrete foundation must be flat and have enough rigidity and strength to undertake the unit's weight during running. The height of the foundation is 200 mm (7.87inch) to 300 mm (11.8inch), which is determined based on the size of the unit.
- (2) The proportion of the cement, sand, and stone for the concrete is 1:2:4. Place 10 reinforced steel bars ( $\phi 10$  mm) with a space between of 30 mm.
- (3) Use the mortar to flatten the surface of the foundation. Sharp edges must be chamfered.
- (4) When the foundation is built on a concrete floor, crushed stones are not required. But the foundation surface must be roughened.
- (5) Clear the oil stains, crushed stones, dirt, and water in the reserved bolt hole of the foundation and install a temporary cover before installing bolts.
- (6) Build a drainage ditch around the foundation to discharge the condensate water.
- (7) If the air conditioner is installed on the roof, check the intensity of the building and take waterproof measures.
- (8) If a u-steel foundation is adopted, the structure must be designed with sufficient rigidity and strength.

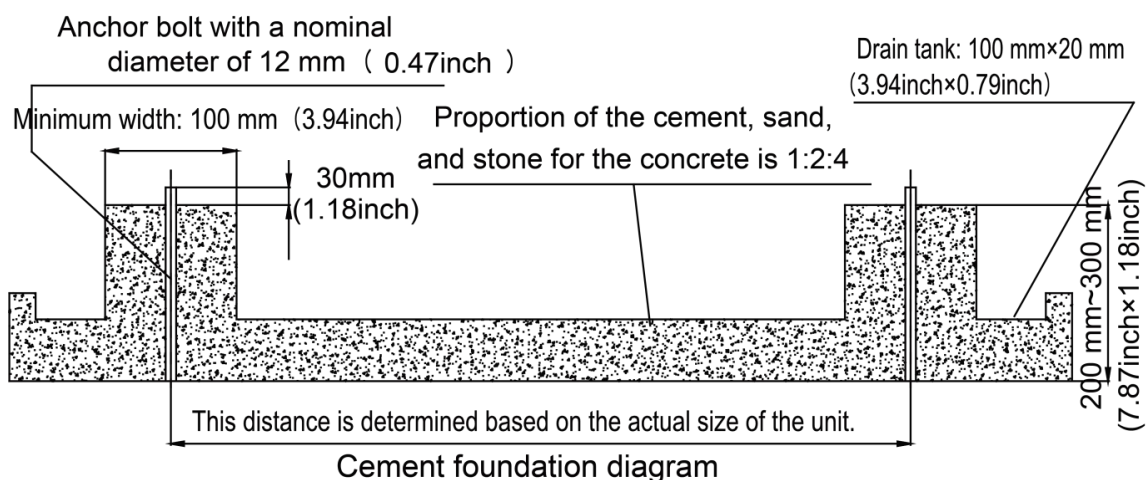

## ▲WARNING

- Install where it can sufficiently support the weight of the outdoor unit. If the support strength is not enough, the outdoor unit may drop and hurt people.
- Install where the outdoor unit may not fall in strong wind or earthquake. If there is a fault in the supporting conditions, the outdoor unit may fall and hurt people.
- Please take extra cautions on the supporting strength of the ground, liquid outlet treatment (treatment of the liquid flowing out of the outdoor unit in operation), and the passages of the pipe and wiring, when making the ground support.
- Do not use tube or pipe for liquid outlet in the Base pan. Use drainage instead for liquid outlet. The tube or pipe may freeze and the liquid may not be drained.

## ▲WARNING

- Be sure to remove the MDF (wood support) of the bottom side of the outdoor unit Base Pan before fixing the bolt. It may cause the unstable state of the outdoor settlement, and may cause freezing of the heat exchanger resulting in abnormal operations.
- Be sure to remove the MDF (wood support) of the bottom side of the outdoor unit before welding. Not removing MDF causes hazard of fire during welding.

## 4.2 ODU FIXING

Fix the ODU to the foundation with four M12 bolts securely to reduce vibration and noise.

## 4.3 VIBRATION REDUCTION FOR ODU

The ODU must be fixed securely. Apply a thick rubber sheet or corrugated damping rubber pad with thickness of 200 mm (7.87inch) or more and width of 100 mm (3.94inch) or more between the ODU and the foundation, as shown in the following figures.

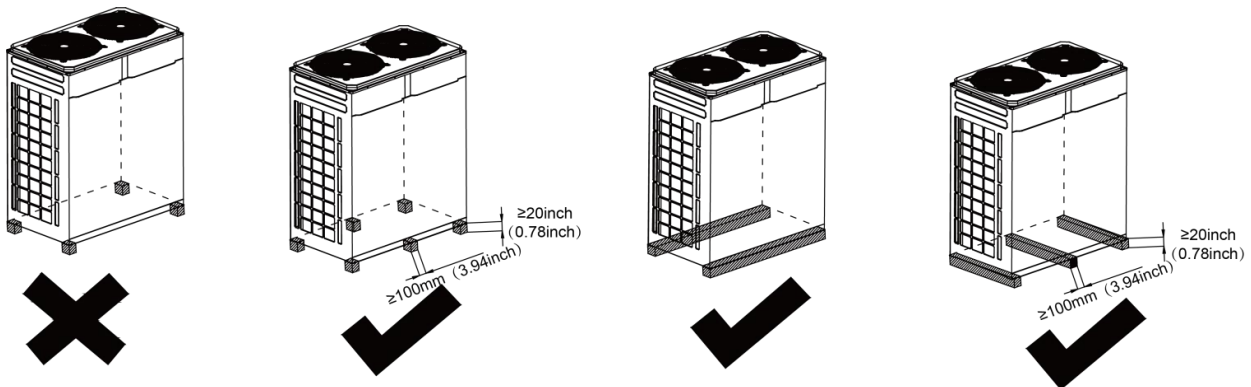



# 5 PIPING CONNECTION

## 5.1 Schematic Diagram of Piping Connection

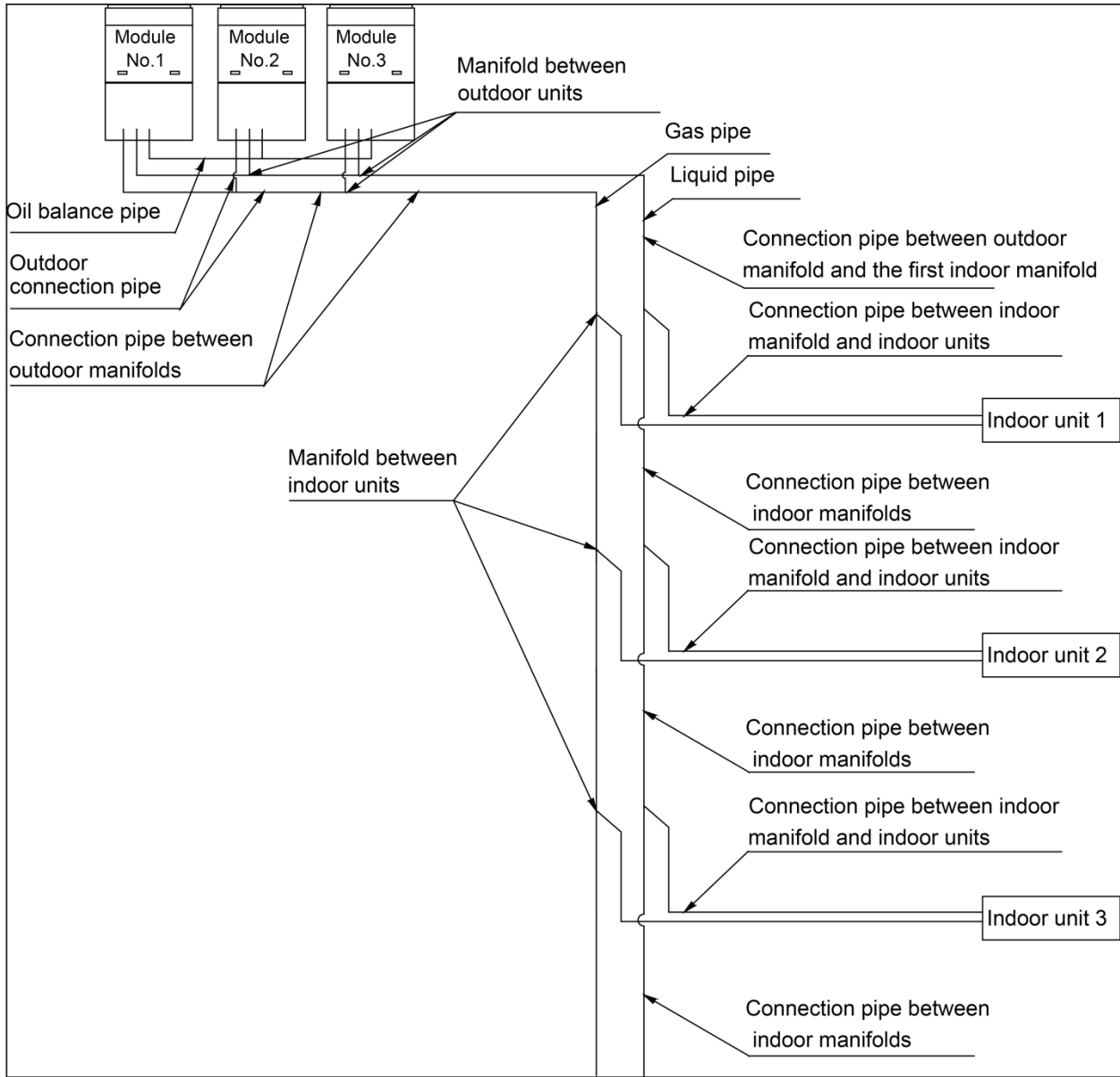

## 5.2 Schematic Diagram of Piping Sequence

GMV-72WM/B-F (U) and GMV-72WM/B-U(U)

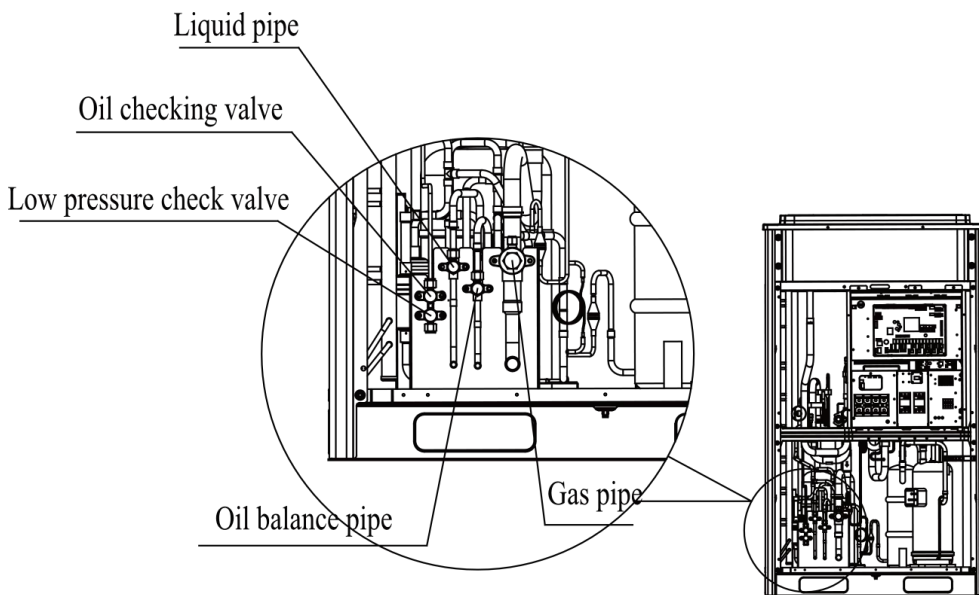

GMV-96WM/B-F (U), GMV-120WM/B-F (U) , GMV-96WM/B-U (U), GMV-120WM/B-U (U) and GMV-144WM/B1-F (U)

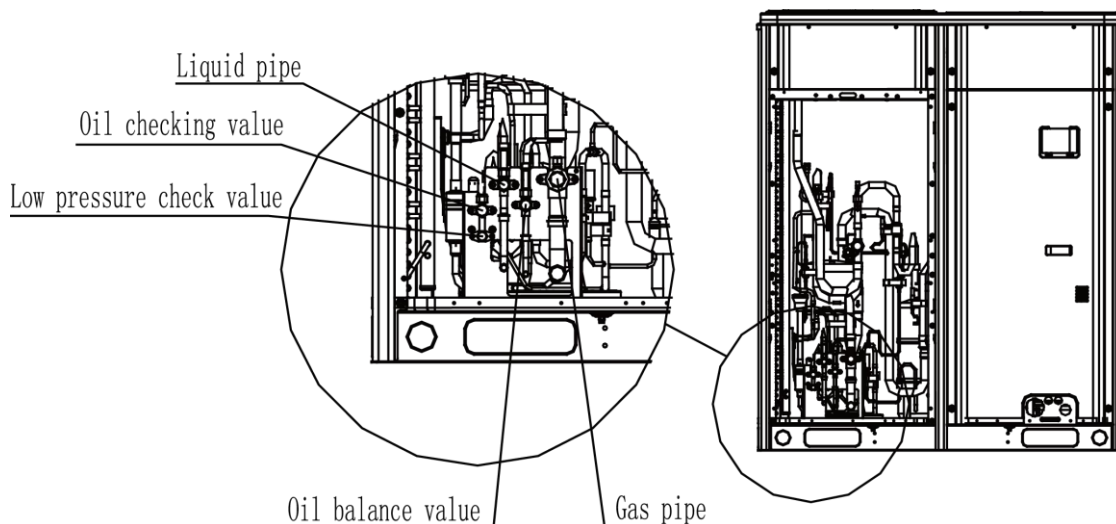

GMV-168WM/B1-F (U)

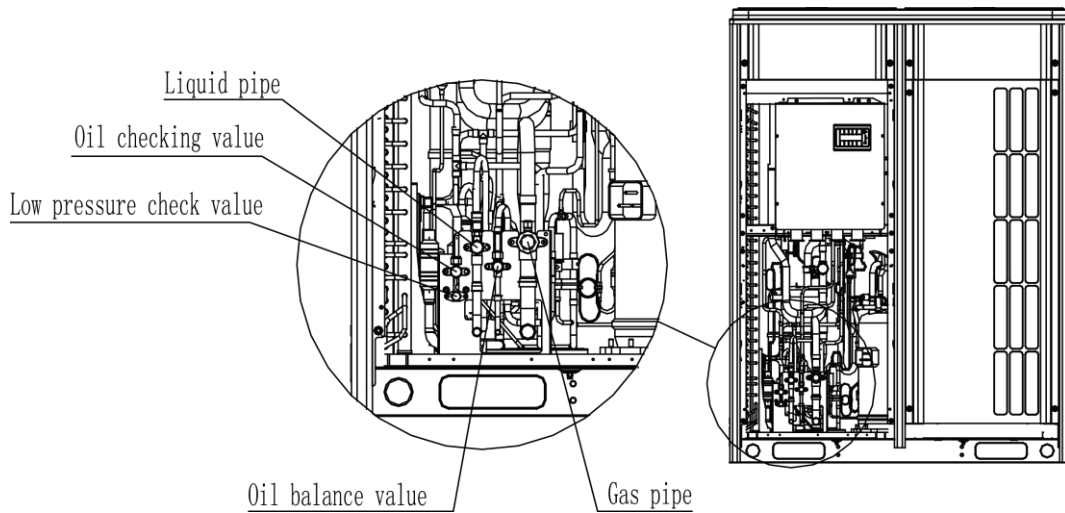

Pipe connection diagram of outdoor modules

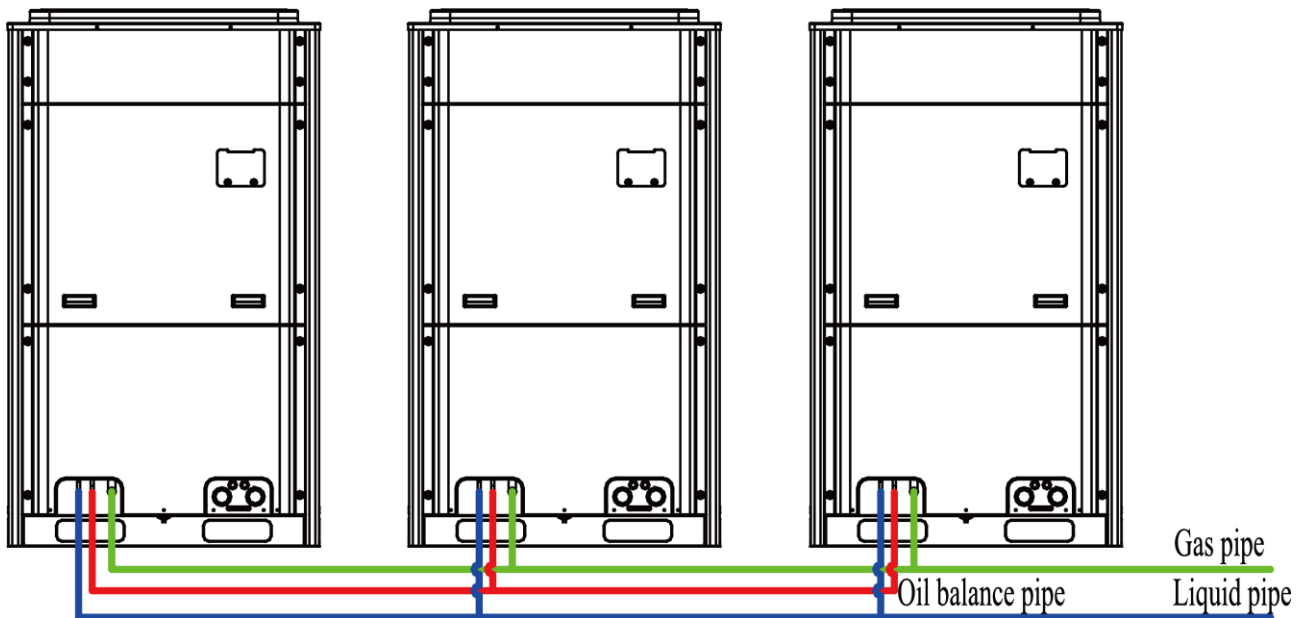

Each ODU system can be connected to multiple IDUs. Detailed information about the number of units to be connected and capacity ranges is shown in the following table:

208/230V 3~ 60Hz

Model	Maximum Number of Connected IDUs (units)	Capacity Range of Connected IDU (kBtu/h)	
		Minimum Capacity	Maximum Capacity
GMV-72WM/B-F(U)	13	36.0	97.2
GMV-96WM/B-F(U)	16	48.0	129.6
GMV-120WM/B-F(U)	19	60.0	162.0
GMV-144WM/B1-F(U)	23	72.0	194.4
GMV-168WM/B1-F(U)	29	84.0	226.8
GMV-144WM/B-F(U)	23	72.0	194.4
GMV-168WM/B-F(U)	29	84.0	226.8
GMV-192WM/B-F(U)	33	96.0	259.2
GMV-216WM/B-F(U)	36	108.0	291.6

Model	Maximum Number of Connected IDUs (units)	Capacity Range of Connected IDU (kBtu/h)	
		Minimum Capacity	Maximum Capacity
GMV-240WM/B-F(U)	39	120.0	324.0
GMV-264WM/B-F(U)	46	132.0	356.4
GMV-288WM/B-F(U)	50	144.0	388.8
GMV-312WM/B-F(U)	53	156.0	421.2
GMV-336WM/B-F(U)	56	168.0	453.6
GMV-360WM/B-F(U)	59	180.0	486.0

460V 3~ 60Hz

Model	Maximum Number of Connected IDUs (units)	Capacity Range of Connected IDU (kBtu/h)	
		Minimum Capacity	Maximum Capacity
GMV-72WM/B-U(U)	13	36.0	97.2
GMV-96WM/B-U(U)	16	48.0	129.6
GMV-120WM/B-U(U)	19	60.0	162.0
GMV-144WM/B-U(U)	23	72.0	194.4
GMV-168WM/B-U(U)	29	84.0	226.8
GMV-192WM/B-U(U)	33	96.0	259.2
GMV-216WM/B-U(U)	36	108.0	291.6
GMV-240WM/B-U(U)	39	120.0	324.0
GMV-264WM/B-U(U)	46	132.0	356.4
GMV-288WM/B-U(U)	50	144.0	388.8
GMV-312WM/B-U(U)	53	156.0	421.2
GMV-336WM/B-U(U)	56	168.0	453.6
GMV-360WM/B-U(U)	59	180.0	486.0

### **▲ CAUTION**

- During installation, please strictly follow the above capacity range and number to construct, otherwise, units may work abnormally and compressors may even be damaged

### 5.3 Allowable pipe length and drop height among indoor and outdoor units

Y type branch joint is adopted to connected indoor and outdoor units. Connecting method is shown in the figure below.

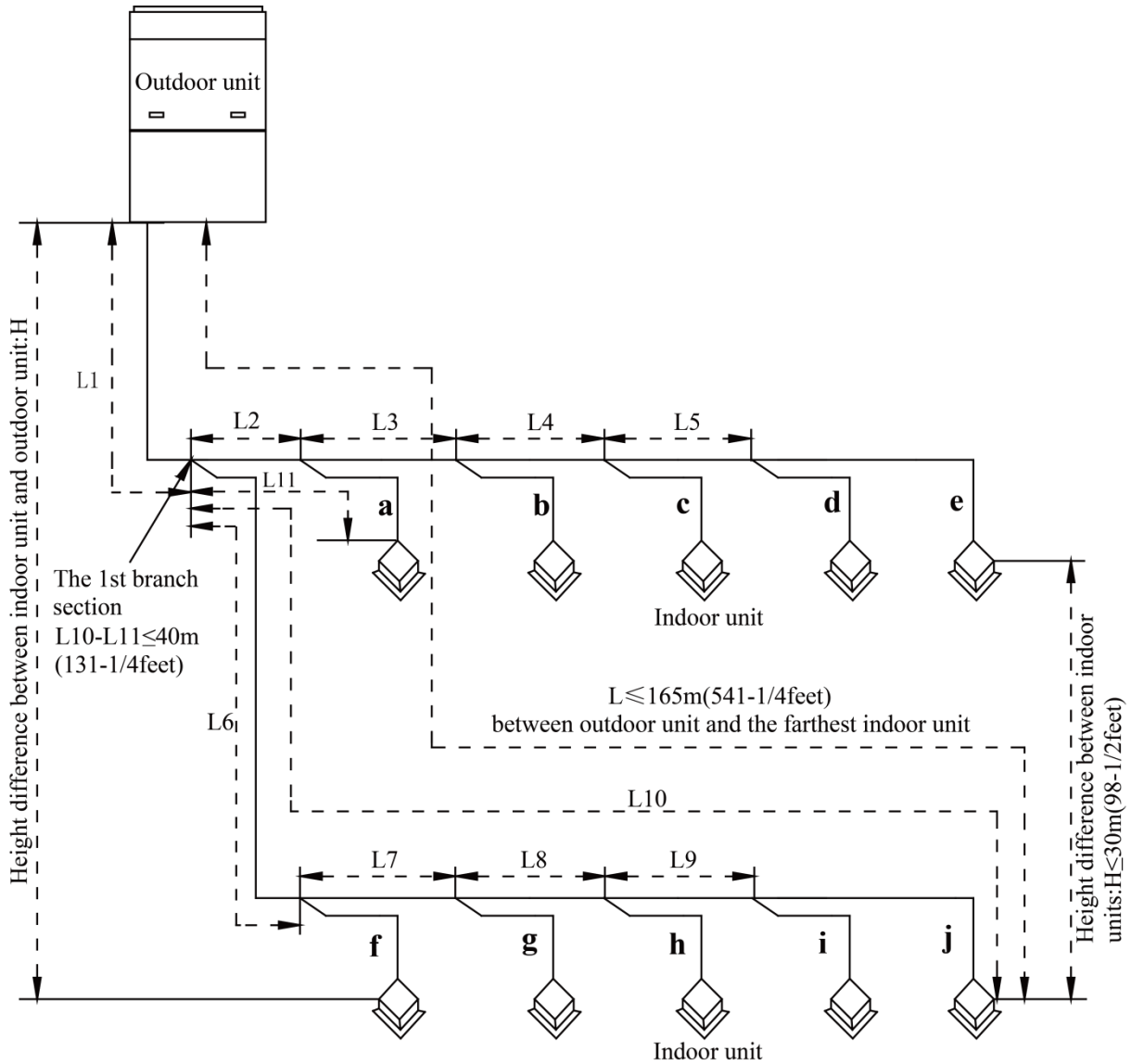

Remark: Equivalent length of one Y-type manifold is about 0.5m (1-3/4feet).

L10: Length from the first branch to the farthest IDU;

L11: Length from the first branch to the nearest IDU;

Equivalent length of branch of IDU is 0.5m (1-3/4ft.).

R410A Refrigerant System		Allowable Value m(ft.)	Fitting Pipe
Total length (actual length) of fitting pipe		≤1000(3280-3/4)	$L1+L2+L3+L4+...+L9+a+b+...+i+j$
Length of farthest fitting pipe m(ft.)	Actual length	≤165(541-1/4)	$L1+L6+L7+L8+L9+j$
	Equivalent length	≤190(623-1/4)	
Difference between the pipe length from the first branch of IDU to the farthest IDU and the pipe length from the first branch of IDU to the nearest IDU		≤40(131-1/4)	L10-L11

Equivalent length from the first branch to the furthest piping (1)		≤40(131-1/4)	L6+L7+L8+L9+j
Height difference between outdoor unit and indoor unit	Outdoor unit at upper(2)	≤90(295-1/4)	—
	Outdoor unit at lower(2)	≤90(295-1/4)	—
Height difference between indoor units		≤30(98-2/4)	—
Maximum length of Main pipe(3)		<90(295-1/4)	L1
From IDU to its nearest branch (4)		≤40(131-1/4)	a,b,c,d,e,f,g,h,i,j

**NOTICE!**

(1) Normally, the pipe length from the first branch of IDU to the farthest IDU is 40m (131-1/4ft.).

Under the following conditions, the length can reach 90m (295-1/4ft.).

1) Actual length of pipe in total:  $L1+L2 \times 2+L3 \times 2+L4 \times 2+\dots+L9 \times 2+a+b+\dots+i+j \leq 1000m$  (3280-3/4ft.).

2) Length between each IDU and its nearest branch a, b, c, d, e, f, g, h, i, j ≤ 40m (131-1/4ft.).

3) Difference between the pipe length from the first branch of IDU to the farthest IDU and the pipe length from the first branch of IDU to the nearest IDU:  $L10-L11 \leq 40m$  (131-1/4ft.).

(2) When the maximum length of the main pipe from ODU to the first branch of IDU is ≥ 90m (295-1/4ft.), then adjust the pipe size of the gas pipe and liquid pipe of main pipe according to the following table.

GMV-\*\*WM/B-F (U) and GMV-\*\*WM/B1-F (U)

Outdoor Model	Gas pipe size mm(in.)	Liquid pipe size mm(in.)
GMV-72WM/B-F(U)	No need to enlarge pipe size	No need to enlarge pipe size
GMV-96WM/B-F(U)	No need to enlarge pipe size	Φ12.7(1/2)
GMV-120WM/B-F(U)	No need to enlarge pipe size	Φ15.9(5/8)
GMV-144WM/B1-F(U)	Φ34.9(1-3/8)	Φ15.9(5/8)
GMV-168WM/B1-F(U)	Φ34.9(1-3/8)	Φ19.05(3/4)
GMV-144WM/B-F(U)	Φ34.9(1-3/8)	Φ15.9(5/8)
GMV-168WM/B-F(U)	Φ34.9(1-3/8)	Φ19.05(3/4)
GMV-192WM/B-F(U)	Φ34.9(1-3/8)	Φ19.05(3/4)
GMV-216WM/B-F(U)	Φ34.9(1-3/8)	Φ19.05(3/4)
GMV-240WM/B-F(U)	No need to enlarge pipe size	Φ19.05(3/4)
GMV-264WM/B-F(U)	No need to enlarge pipe size	Φ22.2(7/8)
GMV-288WM/B-F(U)	No need to enlarge pipe size	Φ22.2(7/8)
GMV-312WM/B-F(U)	No need to enlarge pipe size	Φ22.2(7/8)
GMV-336WM/B-F(U)	No need to enlarge pipe size	Φ22.2(7/8)
GMV-360WM/B-F(U)	No need to enlarge pipe size	Φ22.2(7/8)

GMV-\*\*WM/B-U (U)

Outdoor Model	Gas pipe size mm(in.)	Liquid pipe size mm(in.)
GMV-72WM/B-U(U)	No need to enlarge pipe size	No need to enlarge pipe size
GMV-96WM/B-U(U)	No need to enlarge pipe size	Φ12.7(1/2)
GMV-120WM/B-U(U)	No need to enlarge pipe size	Φ15.9(5/8)

Outdoor Model	Gas pipe size mm(in.)	Liquid pipe size mm(in.)
GMV-144WM/B-U(U)	Φ34.9(1-3/8)	Φ15.9(5/8)
GMV-168WM/B-U(U)	Φ34.9(1-3/8)	Φ19.05(3/4)
GMV-192WM/B-U(U)	Φ34.9(1-3/8)	Φ19.05(3/4)
GMV-216WM/B-U(U)	Φ34.9(1-3/8)	Φ19.05(3/4)
GMV-240WM/B-U(U)	No need to enlarge pipe size	Φ19.05(3/4)
GMV-264WM/B-U(U)	No need to enlarge pipe size	Φ22.2(7/8)
GMV-288WM/B-U(U)	No need to enlarge pipe size	Φ22.2(7/8)
GMV-312WM/B-U(U)	No need to enlarqe pipe size	Φ22.2(7/8)
GMV-336WM/B-U(U)	No need to enlarqe pipe size	Φ22.2(7/8)
GMV-360WM/B-U(U)	No need to enlarqe pipe size	Φ22.2(7/8)

If the length between an IDU and its nearest branch is above 10m (32-3/4feet), then double the size of the liquid pipe of IDU (only for the pipe size that is ≤6.35mm (1/4inch)).

### 5.4 Connection Pipe among Outdoor Modules

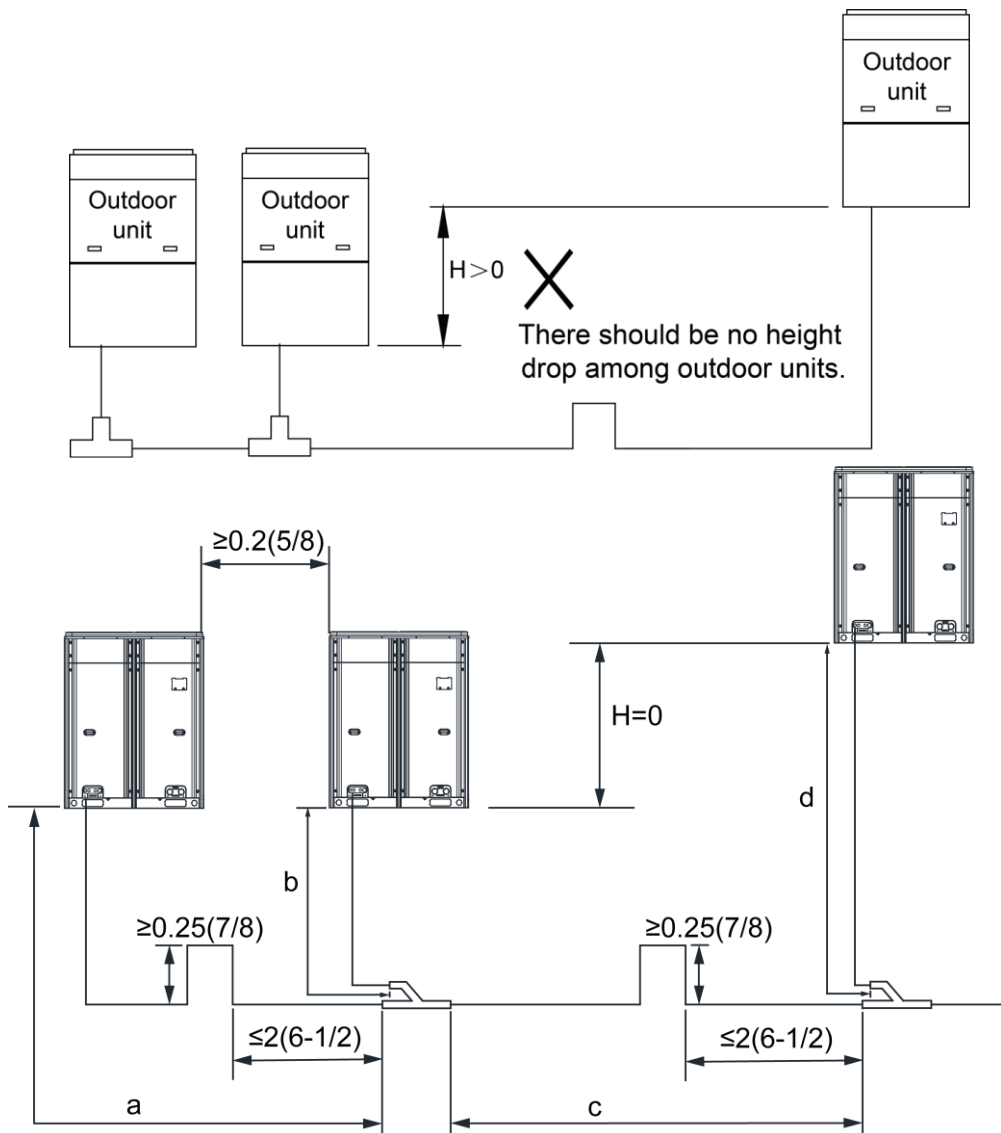

**NOTICE!** When the distance between outdoor units exceeds 2m (6-1/2ft.), U-type oil trap should be added at low pressure gas pipe.  $a+c \leq 10m(32-7/8ft.)$ ;  $b+c \leq 10m(32-7/8ft.)$ ;  $d \leq 10m(32-7/8ft.)$ .

The pipeline between outdoor units should be installed as follows:

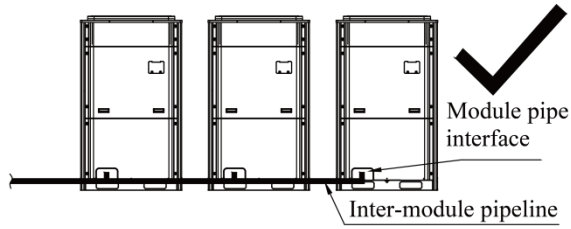

All the inter-module pipelines are kept horizontal with the module pipe interface.

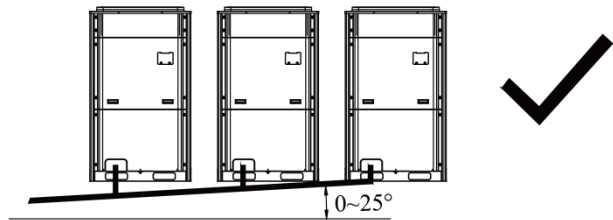

All the inter-module pipelines are located under the module pipe interface and have an upward sloping of 0°C to 25°C.

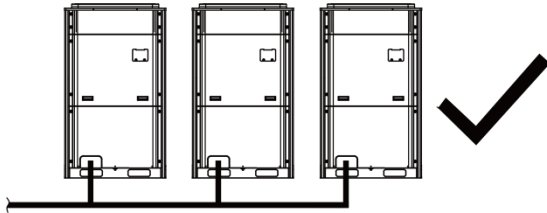

All the inter-module pipelines are located under the module pipe interface and kept horizontal.

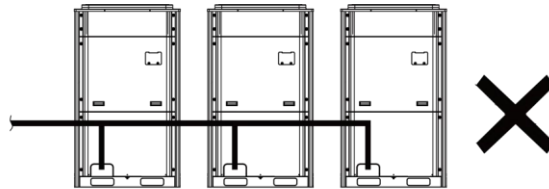

The inter-module pipeline is located above the module pipe interface

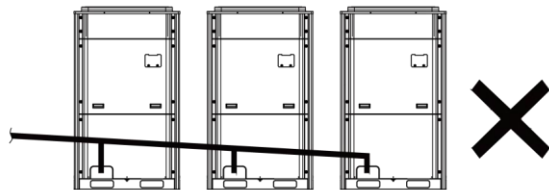

The inter-module pipeline is located above the module pipe interface

### 5.5 Fitting pipe between Outdoor Unit and the First Manifold

1. For single module system, pipe size (between outdoor unit and the first manifold) is determined by that of outdoor unit.

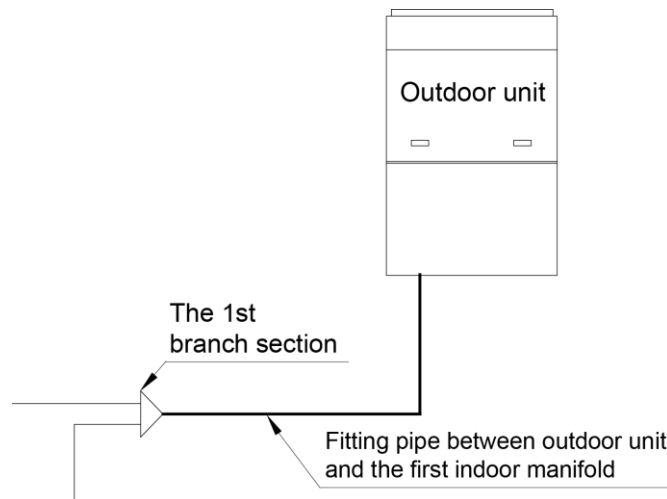



Pipe size of basic outdoor module is shown as follows:

Basic Module		Pipe between ODU and the first branch of IDU	
		Gas Pipe mm(inch)	Liquid Pipe mm(inch)
GMV-72WM/B-F(U)	GMV-72WM/B-U(U)	Φ19.05(3/4)	Φ9.52(3/8)
GMV-96WM/B-F(U)	GMV-96WM/B-U(U)	Φ22.2(7/8)	Φ9.52(3/8)
GMV-120WM/B-F(U)	GMV-120WM/B-U(U)	Φ28.6(1-1/8)	Φ12.7(1/2)
GMV-144WM/B1-F(U)	/	Φ28.6(1-1/8)	Φ12.7(1/2)
GMV-168WM/B1-F(U)	/	Φ28.6(1-1/8)	Φ15.9(5/8)

2. For multi-module unit, select appropriate manifold connected to outdoor module as per the pipe size of basic module. Pipe size of basic outdoor module is shown as follows:

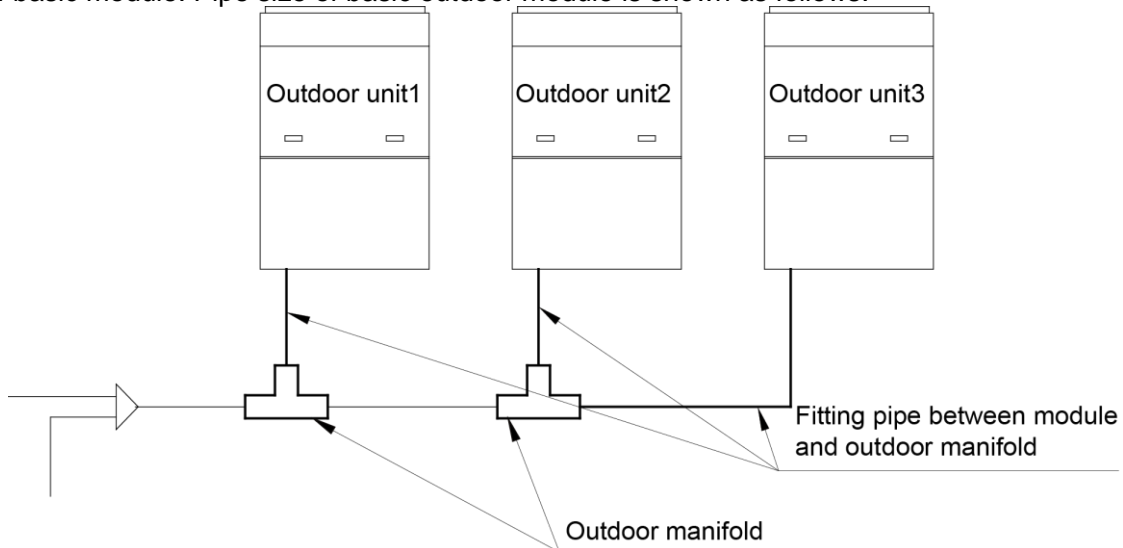

Basic Module		Pipe between module and branch of ODU	
		Gas Pipe mm(inch)	Liquid Pipe mm(inch)
GMV-72WM/B-F(U)	GMV-72WM/B-U(U)	Φ19.05(3/4)	Φ9.52(3/8)
GMV-96WM/B-F(U)	GMV-96WM/B-U(U)	Φ22.2(7/8)	Φ9.52(3/8)
GMV-120WM/B-F(U)	GMV-120WM/B-U(U)	Φ28.6(1-1/8)	Φ12.7(1/2)
GMV-144WM/B1-F(U)	/	Φ28.6(1-1/8)	Φ12.7(1/2)
GMV-168WM/B1-F(U)	/	Φ28.6(1-1/8)	Φ15.9(5/8)

Select the branch of outdoor module:

	Model
Select the branch of outdoor module	ML01/A

**▲ CAUTION**

- Branch of outdoor module must be a Y-type manifold. Never use tee T-type 3-way connector, otherwise, compressor may be damaged.

3. Fitting pipe between two manifolds from basic modules

Pipe size (between two manifolds from basic modules) is based on the total capacity of upstream modules.

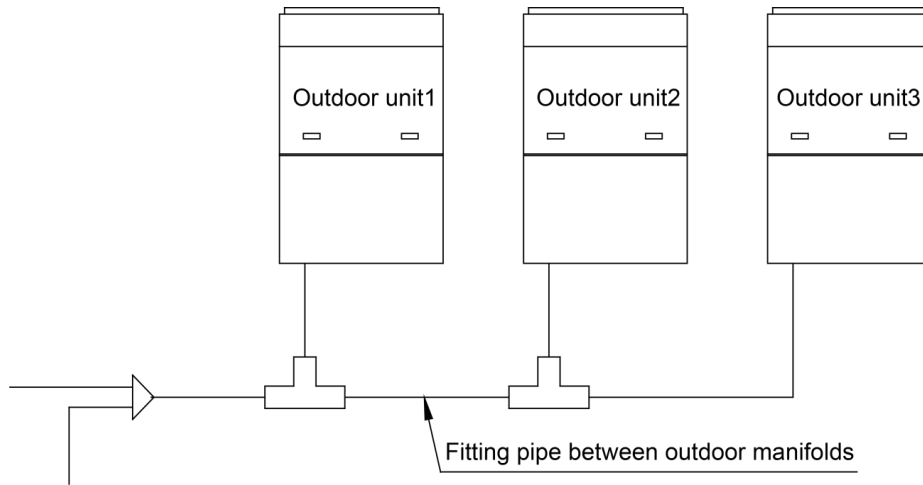

Total capacity of upstream modules Q(Btu/h)	Pipe size between manifolds	
	Gas Pipe mm(in.)	Liquid Pipe mm(in.)
$Q \leq 72000$	$\Phi 19.05(3/4)$	$\Phi 9.52(3/8)$
$72000 < Q \leq 96000$	$\Phi 22.2(7/8)$	$\Phi 9.52(3/8)$
$96000 < Q \leq 144000$	$\Phi 28.6(1-1/8)$	$\Phi 12.7(1/2)$
$144000 < Q \leq 216000$	$\Phi 28.6(1-1/8)$	$\Phi 15.9(5/8)$
$216000 < Q \leq 240000$	$\Phi 34.9(1-3/8)$	$\Phi 15.9(5/8)$
$240000 < Q \leq 336000$	$\Phi 34.9(1-3/8)$	$\Phi 19.05(3/4)$
$336000 < Q$	$\Phi 41.3(1-5/8)$	$\Phi 19.05(3/4)$

4. Fitting pipe between the first manifold from indoor unit and the end manifold from outdoor unit

Single module unit

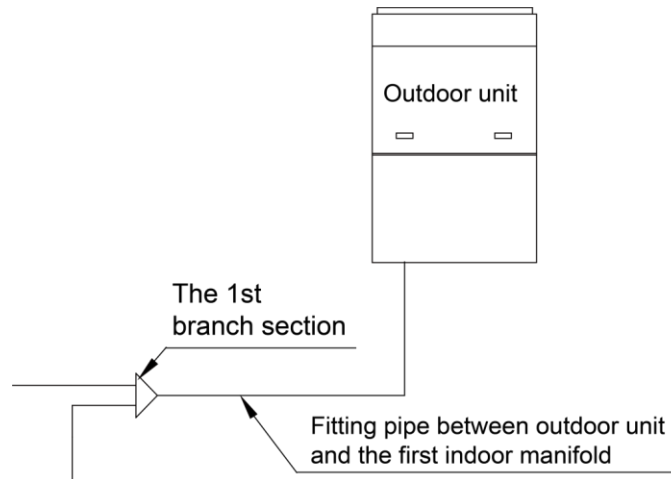

Basic Module		Pipe between ODU and the first branch of IDU	
		Gas Pipe mm(inch)	Liquid Pipe mm(inch)
GMV-72WM/B-F(U)	GMV-72WM/B-U(U)	$\Phi 19.05(3/4)$	$\Phi 9.52(3/8)$
GMV-96WM/B-F(U)	GMV-96WM/B-U(U)	$\Phi 22.2(7/8)$	$\Phi 9.52(3/8)$
GMV-120WM/B-F(U)	GMV-120WM/B-U(U)	$\Phi 28.6(1-1/8)$	$\Phi 12.7(1/2)$
GMV-144WM/B1-F(U)	/	$\Phi 28.6(1-1/8)$	$\Phi 12.7(1/2)$
GMV-168WM/B1-F(U)	/	$\Phi 28.6(1-1/8)$	$\Phi 15.9(5/8)$

For multiple modules, the piping from ODU to the first branch of IDU is based on the total rated capacity of outdoor modules.

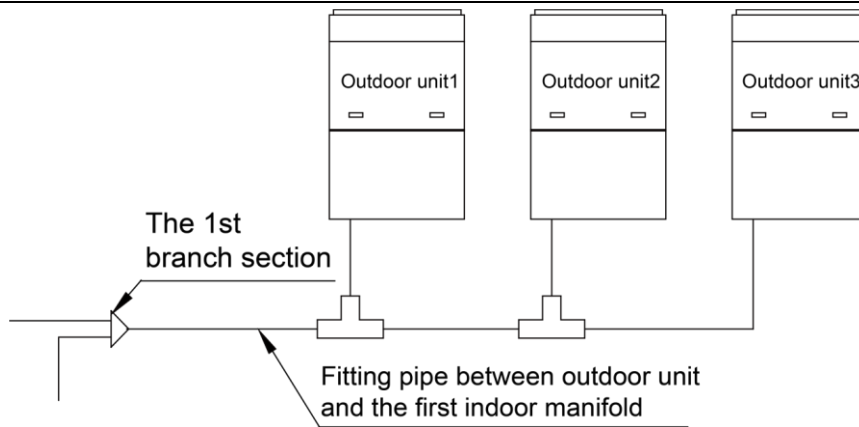

Total rated capacity of outdoor modules (multi-modular system)		Pipe between ODU and the first branch of IDU	
		Gas pipe size mm(inch)	Liquid pipe size mm(inch)
GMV-144WM/B-F(U)	GMV-144WM/B-U(U)	Φ28.6(1-1/8)	Φ12.7(1/2)
GMV-168WM/B-F(U)	GMV-168WM/B-U(U)	Φ28.6(1-1/8)	Φ15.9(5/8)
GMV-192WM/B-F(U)	GMV-192WM/B-U(U)	Φ28.6(1-1/8)	Φ15.9(5/8)
GMV-216WM/B-F(U)	GMV-216WM/B-U(U)	Φ28.6(1-1/8)	Φ15.9(5/8)
GMV-240WM/B-F(U)	GMV-240WM/B-U(U)	Φ34.9(1-3/8)	Φ15.9(5/8)
GMV-264WM/B-F(U)	GMV-264WM/B-U(U)	Φ34.9(1-3/8)	Φ19.05(3/4)
GMV-288WM/B-F(U)	GMV-288WM/B-U(U)	Φ34.9(1-3/8)	Φ19.05(3/4)
GMV-312WM/B-F(U)	GMV-312WM/B-U(U)	Φ34.9(1-3/8)	Φ19.05(3/4)
GMV-336WM/B-F(U)	GMV-336WM/B-U(U)	Φ41.3(1-5/8)	Φ19.05(3/4)
GMV-360WM/B-F(U)	GMV-360WM/B-U(U)	Φ41.3(1-5/8)	Φ19.05(3/4)

5. Manifold at indoor unit side

Manifold at indoor unit side can be selected as per total capacity of downstream indoor unit(s).

Refer to the following table.

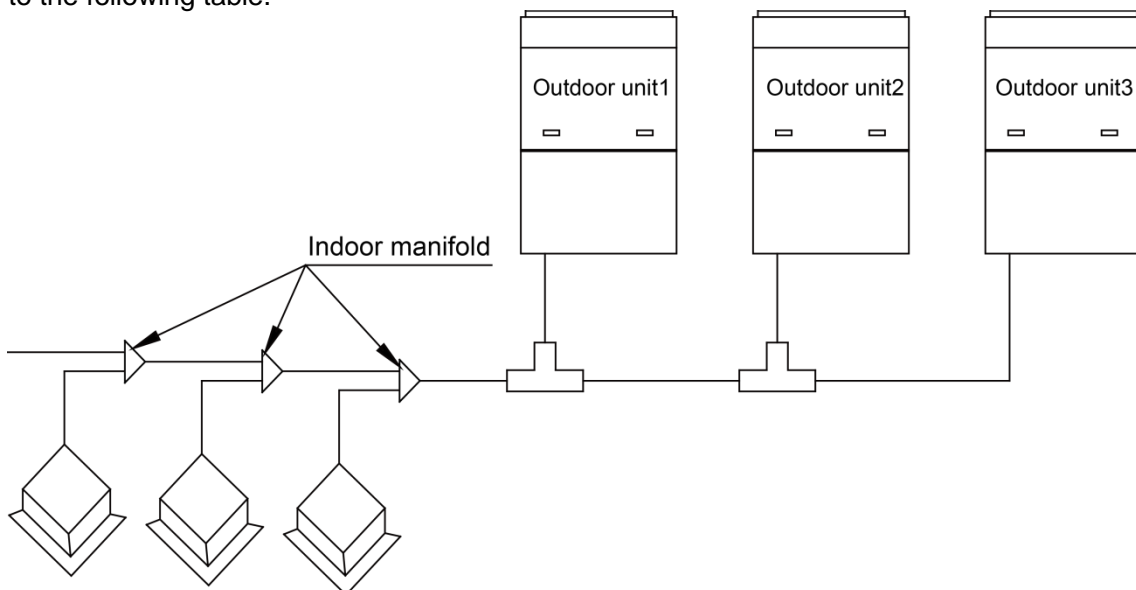

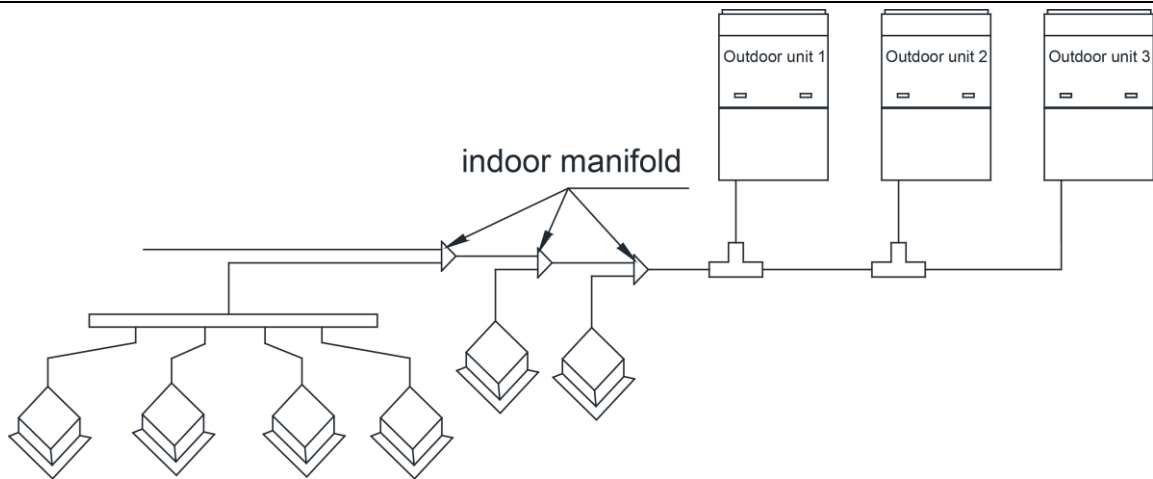

R410A Refrigerant System	Total capacity of downstream indoor unit(s) C (KBtu/h)	Model
Y-type Manifold	$C < 68$	FQ01A/A
	$68 \leq C \leq 102$	FQ01B/A
	$102 < C \leq 239$	FQ02/A
	$239 < C$	FQ03/A
T- type Manifold	$C \leq 136$	FQ14/H1
	$C \leq 232$	FQ18/H1
	$232 < C$	FQ18/H2

6. Fitting pipe between manifolds

Pipe size (between two manifolds at indoor unit side) is based on the total capacity of upstream indoor unit(s).

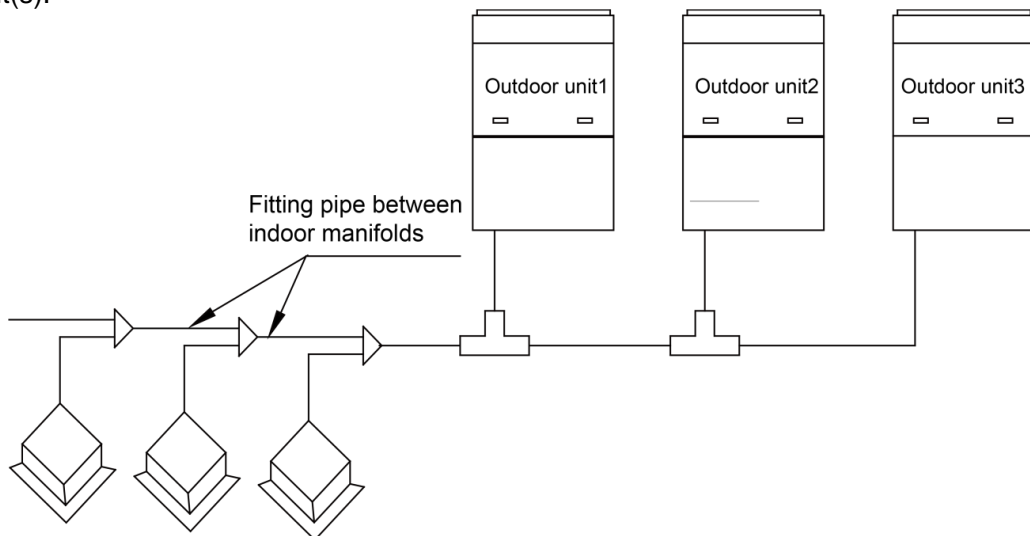

Total capacity of downstream indoor unit(s) C(Btu/h)	Dimension of the pipe of indoor branch	
	Gas Pipe mm(in.)	Liquid Pipe mm(in.)
$C \leq 17100$	$\Phi 12.7(1/2)$	$\Phi 6.35(1/4)$
$17100 < C \leq 48500$	$\Phi 15.9(5/8)$	$\Phi 9.52(3/8)$
$48500 < C \leq 72000$	$\Phi 19.05(3/4)$	$\Phi 9.52(3/8)$
$72000 < C \leq 96000$	$\Phi 22.2(7/8)$	$\Phi 9.52(3/8)$
$96000 < C \leq 144000$	$\Phi 28.6(1-1/8)$	$\Phi 12.7(1/2)$
$144000 < C \leq 216000$	$\Phi 28.6(1-1/8)$	$\Phi 15.9(5/8)$
$216000 < C \leq 240000$	$\Phi 34.9(1-3/8)$	$\Phi 15.9(5/8)$
$240000 < C \leq 336000$	$\Phi 34.9(1-3/8)$	$\Phi 19.05(3/4)$
$336000 < C$	$\Phi 41.3(1-5/8)$	$\Phi 19.05(3/4)$

7. Fitting pipe between indoor unit and manifold  
 Manifold should be matched with fitting pipe of indoor unit.

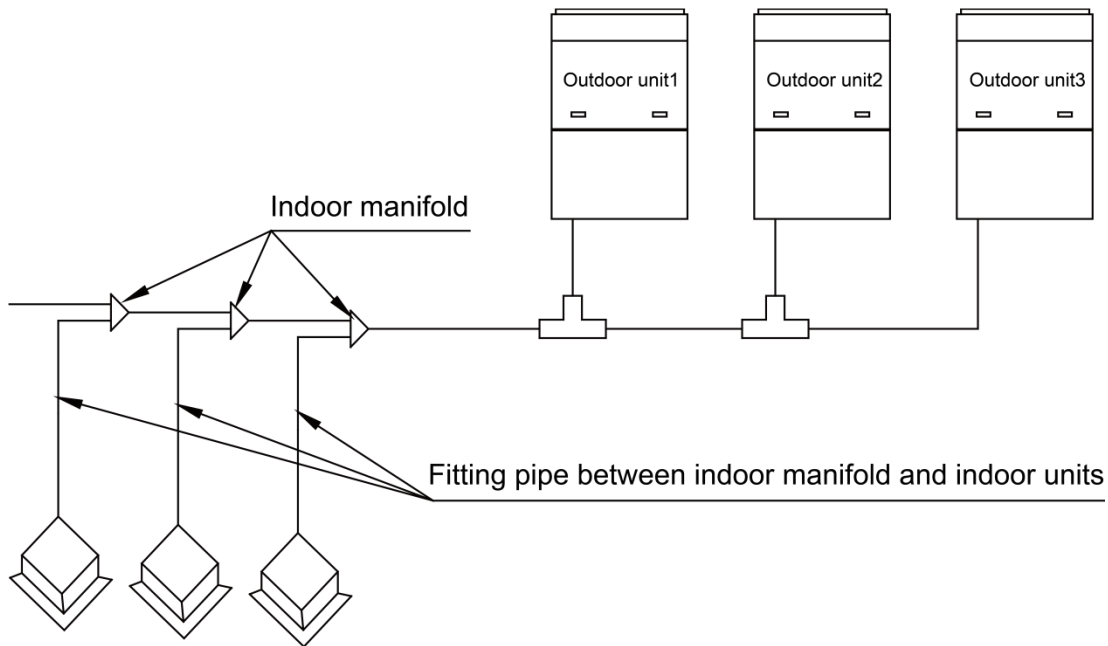

Rated capacity of indoor unit C(Btu/h)	Pipe between indoor branch and IDU	
	Gas Pipe mm(in.)	Liquid Pipe mm(in.)
$C \leq 9500$	$\Phi 9.52(3/8)$	$\Phi 6.35(1/4)$
$9500 < C \leq 17100$	$\Phi 12.7(1/2)$	$\Phi 6.35(1/4)$
$17100 < C \leq 48500$	$\Phi 15.9(5/8)$	$\Phi 9.52(3/8)$
$48500 < C \leq 72000$	$\Phi 19.05(3/4)$	$\Phi 9.52(3/8)$
$72000 < C$	$\Phi 22.2(7/8)$	$\Phi 9.52(3/8)$

# 6 PIPE INSTALLATION AND INSULATION

## 6.1 PIPE INSTALLATION FOR THE COOLING SYSTEM

### 6.1.1 Precautions on Pipe Direction Design

Refrigerant pipe layout must be designed in accordance with the following principles:

- (1) The air conditioning installation should not damage the bearing structure or the decorative style.  
 Air conditioning pipes should be laid out along the bottom of beam as possible. If pipes meet one another at the same elevation, process based on the following principles:
  - 1) Drain pipes enjoy the highest priority. Air ducts and pressure pipes should leave places for gravity pipes.
  - 2) Air ducts and small pipes should leave places for major pipes.
- (2) The refrigerant pipe layout must be optimal in actual engineering with minimum pipe length and bends. In this way, the performance of the unit can be maximized.
- (3) The refrigerant pipe cannot affect air discharge and return of internal units. The minimum distance between the refrigerant pipe with an insulation layer and the air return box is 300 mm (11.8inch). If the air return or manhole is at the right lower part of the unit, the minimum distance is 150 mm (5.9inch). When the refrigerant pipe needs to be laid at the air outlet side, avoid laying

the pipe at the front of the air outlet. The refrigerant pipe cannot connect to any part of the unit except the joint points. If the preceding principles are not followed, performance of the unit will be affected and running noises will be increased.

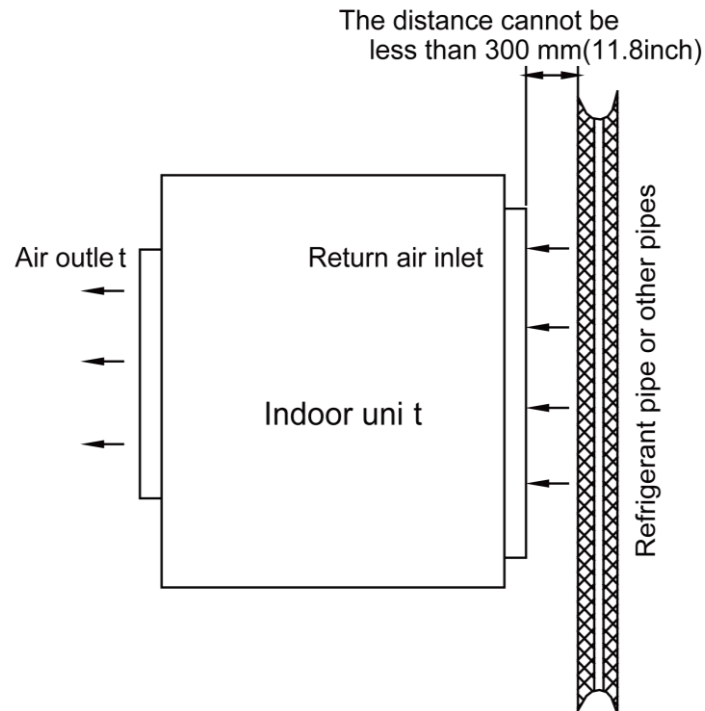

- (4) The refrigerant pipe must be laid away from the manhole of the unit so that sufficient space can be reserved for maintenance.
- (5) The riser should be installed in the air conditioning tube well, and the horizontal pipe should be placed in the ceiling, if possible.

### **▲WARNING**

- Always careful not to leak the refrigerant during welding.
- The refrigerant generates poisonous gas harmful to human body if combusted.
- Do not perform welding in a closed space.
- Be sure to close the cap of the service port to prevent gas leakage after the work.

### **▲CAUTION**

- Please block the pipe knock outs of the front and side panels after installing the pipes (Animals or foreign objects may be brought in to damage the cables.)

## **6.1.2 Processing to Refrigerant Pipes**

### **6.1.2.1 Cut-off and Burring**

Use a special-purpose pipe cutter to cut copper pipes instead of using a hacksaw.

Cut the pipes gently to ensure that the copper pipe does not deform.

After cutting the pipes, use a slicker to grater bur the pipes with the pipe opening inclining downward so that the copper scales do not fall into the pipe.

Allowable deviation: Skewness of the cross section cannot exceed 1% of the copper pipe caliber.

If the copper pipe is not used immediately after cut-off, cover it with a sealing cap or adhesive tape.

#### 6.1.2.2 Pipe Cleaning

Cleaning with a piece of silk cloth: Wrap a thin steel wire with a piece of clean silk cloth. Crumple the cloth into a lump with diameter larger than the pipe calibre. Apply several drops of chlorylene to the cloth. Push the cloth in from one end of the pipe and pull out from the other end. Every time the cloth is pulled out, remove the dust and sundries with chlorylene. Wash repeatedly until the pipe is clean. This method applies to straight pipes.

Cleaning with nitrogen: Blow off all dust and sundries in the pipe with nitrogen. This method applies to coils.

After cleaning, cover the both ends of the pipe with a sealing cap or adhesive tape.

#### 6.1.2.3 Pipe Bending

##### **Processing methods:**

Manual bending: applies to thin copper pipes ( $\Phi 6.35$  mm (1/4 in.) to  $\Phi 12.7$  mm (1/2 in.))

Mechanical bending: applicable range ( $\Phi 6.35$ mm (1/4 in.) to  $\Phi 54.1$ mm (2-1/4 in.))

##### **Requirements:**

The radius of the bending pipe must exceed 3.5D. The ratio of the short diameter after bending to the original diameter must exceed 2/3.

##### **Precautions:**

During bending, there must be no corrugation or deformation inside the pipe.

The welding point of the pipe should not be at the bending part. The distance between the nozzle welding joint and the bending part should be less than 100 mm (3.94inch).

#### 6.1.2.4 Pipe Expanding

Pipe expanding is used to provide a welding point for pipe connection. Requirements on pipe expanding are as follows:

- (1) All burrs and sundries inside the pipe must be cleared after cut-off.
- (2) Before pipe expanding, apply appropriate amount of lubricant on the surface of the pipe. (The lubricant must meet the refrigerant system's requirements.)
- (3) Pipe expanding length must be in accordance with the insertion depth of the caliber.
- (4) To avoid leakage due to straight lines at the expanding point, turn round the copper pipe and then make corrections.
- (5) Apply appropriate force during pipe expanding to avoid crack.

#### 6.1.2.5 Flaring

Another mode of pipe connection is flare opening connection, which requires pipe flaring before connection. Before pipe flaring, apply appropriate amount of lubricant on the surface of the opening to ensure smooth pass of flaring nuts and avoid pipe distortion. (The lubricant must meet the refrigerant system's requirements.) The concentricity must be ensured after pipe flaring. The sealing face must be intact without any burr, crack, or wrinkle.

Requirements on pipe flaring are as follows:

- (1) End faces of the copper pipe are smooth.
- (2) Burrs and turnups inside the pipe opening must be cleared.
- (3) Install flaring nuts in the pipe before pipe flaring.
- (4) The flared opening must be concentric with the main pipe. No eccentricity is allowed.
- (5) Put the pipe into the root of the pipe expander.
- (6) Longitudinal cracks cannot be generated.

## 6.1.3 Installation of Refrigerant Pipes

### 6.1.3.1 Operation Sequence

The sequence for installing the refrigerant pipe is as follows:

Preparing and installing the support, hanger, and bracket – Piping according to the drawing – Cleaning the pipe→Processing the pipe→Adding an insulation sleeve→Connecting the pipe→Fixing the pipe→Blowing contaminants in the pipe system→Performing an air-tightness test→Performing insulation

### 6.1.3.2 Construction of Built-in Metal Fittings

- (1) Construction of supports, hangers, and brackets for pipes

These parts must be fixed securely in reasonable type and style without any tilt. The surface is clean without any dirt. The parts embedded into the wall or floor cannot be painted or coated and must be free from grease stains.

- (2) Construction of fixing bolts for devices

Ensure sufficient rigidity for the devices. Take anticorrosive measures for exposed part of built-in fittings. If the foundation must be waterproof, takes waterproof measures.

- (3) Construction of steel casings

Equip a steel casing for all pipes which are led through the wall or floor. Pipe welding joints cannot be placed inside the sleeve. The steel casing must be parallel with the bottom of the wall or floor but be 20 mm (0.8inch) or more above the bottom. The diameter of the steel casing must be determined based on the thickness of the insulation layer and the inclination degree of the condensate water pipe. Fill the gap between the pipe and the sleeve with flexible and non-flammable materials. The sleeve cannot be used as a support point of the pipe.

- (4) Operation Sequence

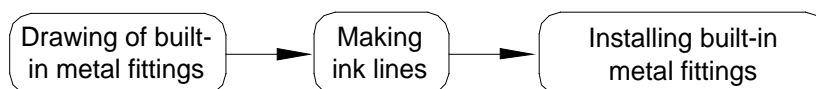

If possible, make ink lines on the ground and project them to the top of the building.

- (5) Installing Built-in Metal Fittings

Select built-in metal fittings in accordance with local regulations.

- (6) Installing Expansion Bolts

Use expansion bolts when built-in metal fittings are unavailable due to design change.



**▲ CAUTION**

- If the foot pedal is 2 m (6.5feets) or more from the ground, there must be three points of support.
- The foot pedal must be tightened securely with the ladder.
- Do not perform operations on the top of the ladder.

**6.1.3.3 Shaping and Fixing of Pipes**

When installing refrigerant pipes, ensure that the directions and branches are correct with minimum length. Use minimum number of braze welding junctions and elbows. Alignment and insulation after installation cannot affect the pipe location and elevation. There shall not be flat bending or corrugation on the pipe after piping.

Use angle steel support, bracket, round steel hanger, U-type pipe clip, or flat steel to fix pipes outside the insulation layer. It is better that the insulation materials be not compressed to ensure good insulation.

The style and workmanship of supports, hangers, and brackets must follow the HVAC Systems Design Handbook.

The minimum distance between supports, hangers, and brackets is listed in the table below:

External Diameter of the Pipe mm(inch)	$\Phi < 19.05(3/4)$	$41.3(1-5/8) > \Phi \geq 19.05(3/4)$	$\Phi \geq 41.3(1-5/8)$
Distance between Horizontal Pipes mm(inch)	1000(39-3/8)	1500(59)	2000(78-3/4)
Distance between Vertical Pipes mm(inch)	1500(59)	2000(78-3/4)	2500(98-1/2)

The pipe led through a wall or beam must be fixed by a support, hanger, or bracket on both ends at the position 300 mm (11-7/8inch) away from the hole.

**6.1.3.4 Pipe Connection**

**(1) Flaring Connection**

The refrigerant pipes and IDUs are connected by using the flare opening. Therefore, the quality of flaring connection must be ensured. The flaring depth of the bell mouth cannot be smaller than the caliber. The flaring direction must face towards the direction of medium flow. Use two torque wrenches to fasten the connection.

**(2) Socket Welding**

The gap between socket components should be proper to ensure that the connection will not loose from the friction surface. The flaring direction of the socket component must face towards the direction of medium flow .During pipe connect, protect the braze welding part according the length specified below:

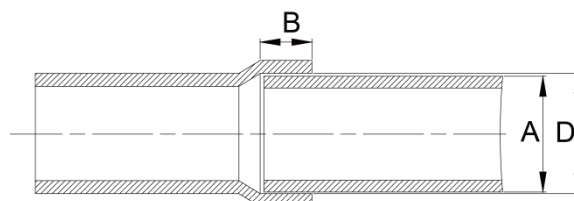

A: External Diameter of the Pipe		B: Minimum Insertion Depth		D-A: Gap between Pipes	
mm	in.	mm	in.	mm	in.
Φ6.35	Φ1/4	6	0.24	0.05-0.21	0.002-0.008
Φ9.52	Φ3/8	7	0.28		
Φ12.7	Φ1/2				
Φ15.8	Φ5/8	8	0.32	0.05-0.27	0.002-0.01
Φ19.05	Φ3/4	10	0.39		
Φ22.2	Φ7/8				
Φ25.4	Φ1				
Φ28.6	Φ1-1/8	12	0.47	0.05-0.30	0.002-0.012
Φ31.8	Φ1-1/4				
Φ38.1	Φ1-1/2	19	0.75	0.15-0.35	0.006-0.014
Φ44.5	Φ1-3/4				

(3) Bell Socket Welding

The bell socket welding is another form of socket welding. It uses the sleeve or pipe in a larger size for welding. The insertion depth cannot be smaller than that required by socket welding.

(4) Flange Connection

The pipes with large caliber and the devices are always connected by using a flange, which must be clean and intact. Before installation, apply lubricant on the surface of the flange. Two flanges must be symmetrical. Fasten with screws at the diagonal direction to avoid inclination.

6.1.3.5 Welding Protection

Aerate with nitrogen before and during welding and keep aerating for 30s after the welding is finished.

Equip a pressure regulator valve to the nitrogen cylinder.

The nitrogen flow is above 4-6 L/min (pressure of 0.02 to 0.05 Mpa) and must be regulated based on the pipe caliber.



• During welding, nitrogen-filling protection must be conducted; otherwise, the remaining substance in pipeline will cause blockage or leakage to the system (e.g. electronic expansion valve), which will result in abnormal operation or even damage the compressor.

6.1.3.6 Requirements on Manifold Installation

Manifolds are used to divert refrigerant. Requirements on manifold installation are as follows:

- (1) Ensure that the manifold is close to the IDU to reduce impact on refrigerant assignment by IDU branches.
- (2) The manifold must be that specified by the manufacture and match with the devices.
- (3) Ensure that the manifold model is correct.
- (4) Manifolds can be laid in the following ways:
  - 1) Horizontal installation: The three ports must be on the same level. The shaping size and assembly angle cannot be changed.

2) Vertical installation: The direction can be upwards or downwards. Three ports must be on the same elevation without inclination.

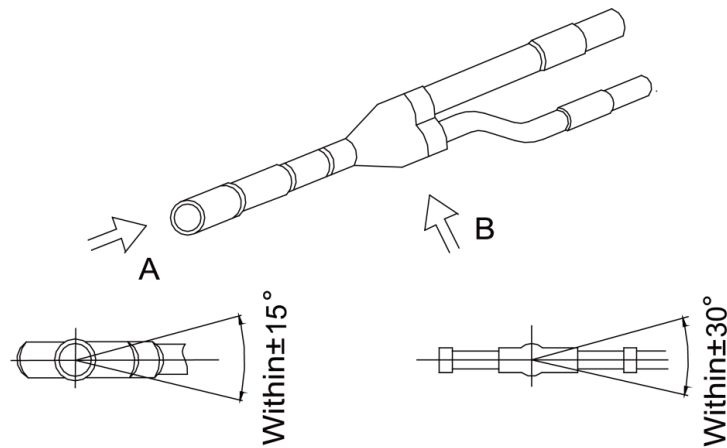

Dia9ram for direction A

Dia9ram for direction B

- 3) The length of a straight pipe between two manifolds cannot be less than 500 mm (19.7in.).
- 4) The length of a straight pipe before the main pipe port of the manifold cannot be less than 500 mm (19-11/16in.).
- 5) The length of a straight pipe between the branch of the manifold and the IDU cannot be less than 500 mm (19-11/16in.).

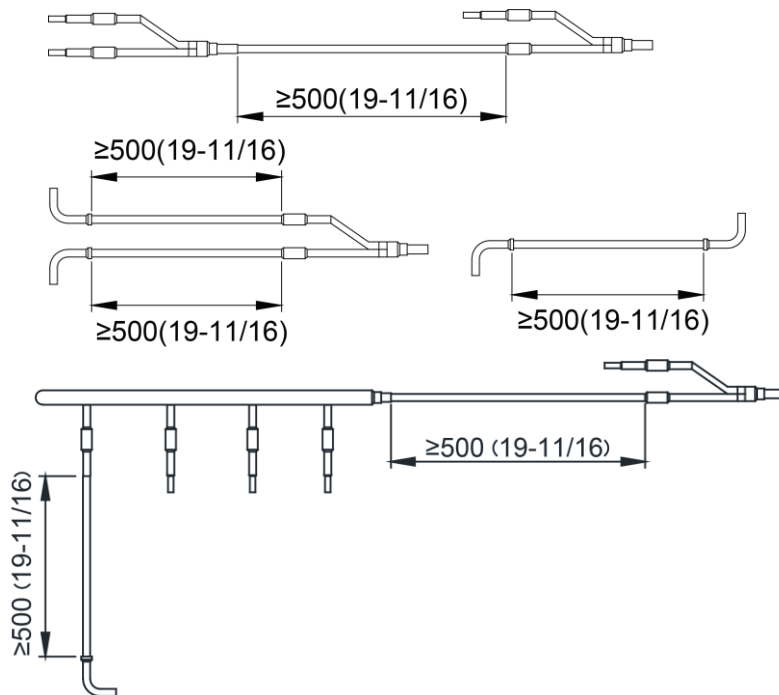

(5) Fixing of manifolds.

There must be three fixing point for both horizontal and vertical installation of the Y-type manifold.

Fixing point 1: 100mm (4in) on the main inlet manifold from the welding point

Fixing point 2: 200mm (7-7/8in.) on the main branched pipe from the welding point

Fixing point 3: 250mm (9-5/6in.) on the branched pipe from the welding point

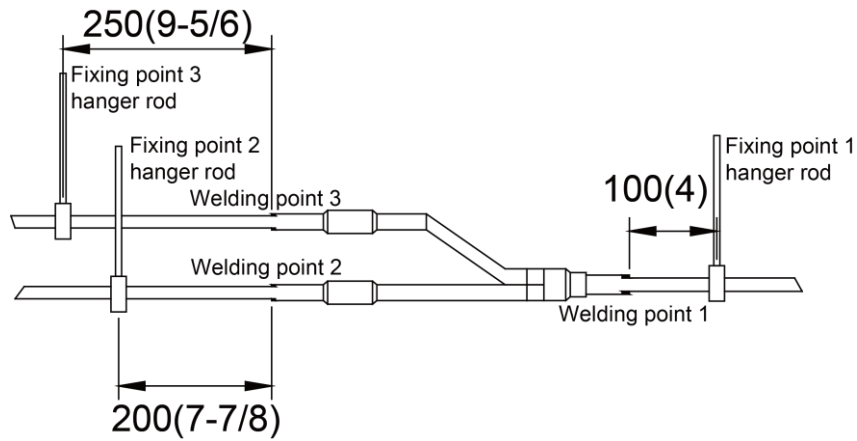

Branches of a manifold must be laid parallel and cannot be wrapped in superimposed mode.

(6) T-type manifold can be laid in the following ways:

1) T-type manifold must be installed horizontally with inclination.

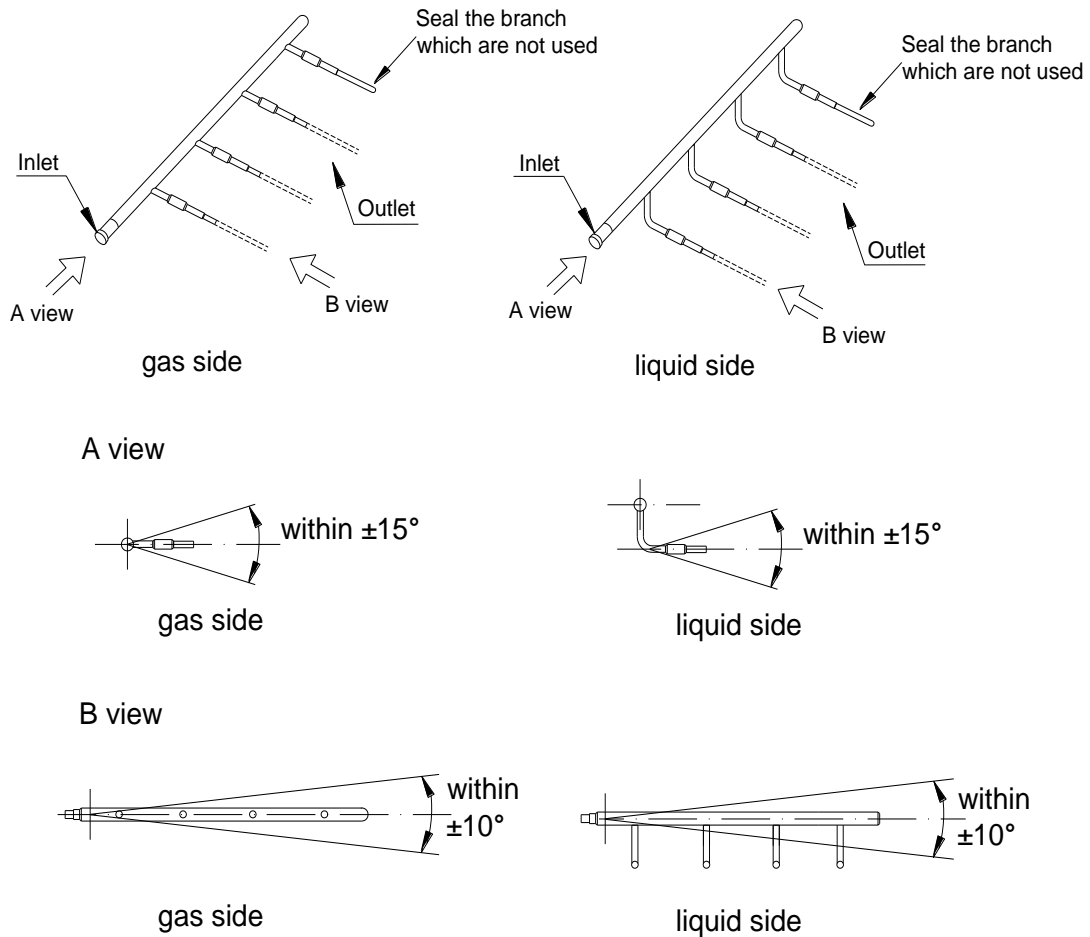

2) The length of a straight pipe between T-type manifold pipe and Y-type manifold pipe cannot be less than 500 mm (19-11/16in.).

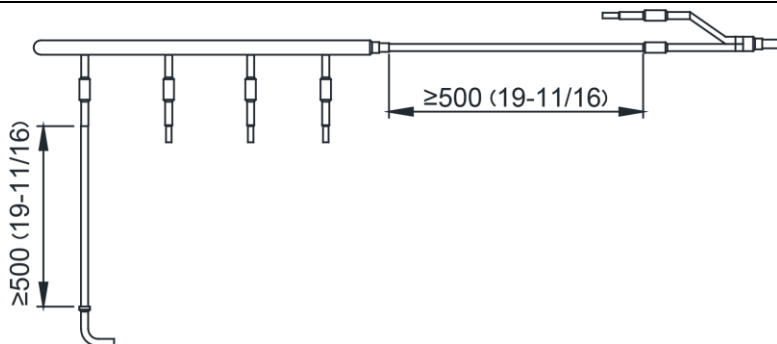

3) The length of a straight pipe between the T-type manifold pipe and the IDU cannot be less than 500 mm (19-11/16in.).

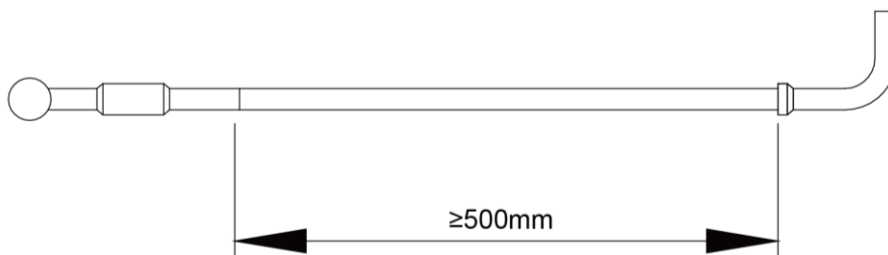

4) Suspend the header to the ceiling and be sure to install it so that the outlet pipes are horizontal at the lower side.

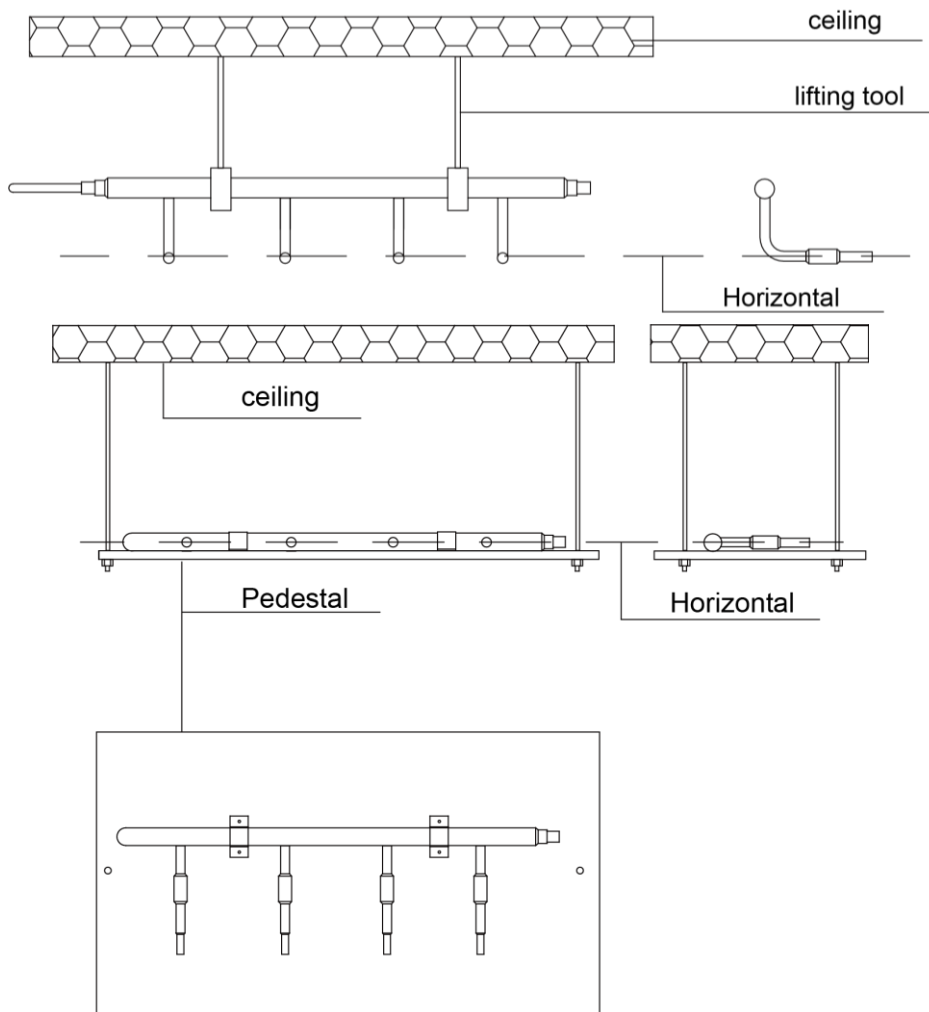

5) The downstream of T-type manifold pipe cannot connect with Y-type manifold pipe and T-type

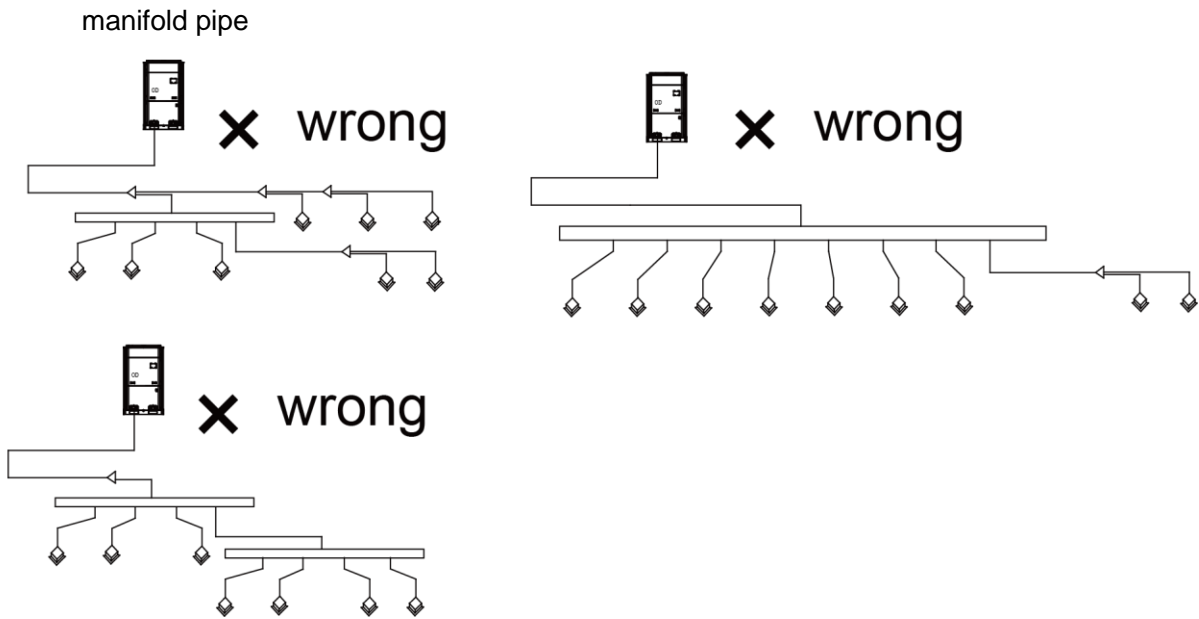

Equivalent length of one Y-type manifold pipe is about 0.5m (19-11/16in.).

Equivalent length of branch of IDU is 0.5m (19-11/16in.).

6) Min & Max Number IDUs connectable with each T-Type manifold pipe

	Min Number IDUs	Max Number IDUs
FQ14/H1	2	4
FQ18/H1	4	8
FQ18/H2	4	8

Max Indoor Unit Capacity connectable is 14kW. If T-Type manifold pipe connectable Indoor Unit Capacity satisfy demand  $48\text{KBtu/h} < \text{Indoor Unit Capacity} \leq 54\text{ KBtu/h}$ , follow need to supply also Reducer / Expander Pipe to connect furthermore gas pipe: pipe size transition  $\Phi 15.9\text{mm}(5/8\text{ in.})$  to  $\Phi 19.05\text{mm}(3/4\text{ in.})$ .

(7) The liquid pipe and gas pipe must have the same length and be laid in the same route.

(8) The Y-type manifold has an attached pipe used to adjust the diameter of different pipes. If the pipe size on site does not match the size of the manifold junction, use the pipe cutter to cut at the middle of the pipe and remove burrs. Then insert the copper pipe to proper depth. A concave bag for positioning is available to the manifold purchased from Gree.

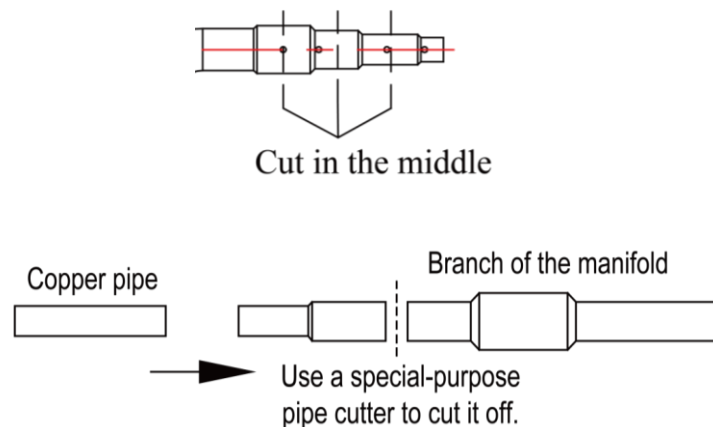

(9) Because the manifold structure is complex, perform with care to ensure tight insulation.

### 6.1.3.7 Pipe Cleaning by Nitrogen

Before connecting the flare opening of the pipe to the IDU, connect the pressure regulator valve on the nitrogen cylinder to the liquid pipe in the outdoor pipe system. Regulate the nitrogen pressure to about 5 kgf/cm<sup>2</sup> and blow nitrogen into the pipe for 1 minute. Repeat this operation for three times till the dirt and water are discharged. After cleaning the liquid pipe, perform the same operation to clean the gas pipe.

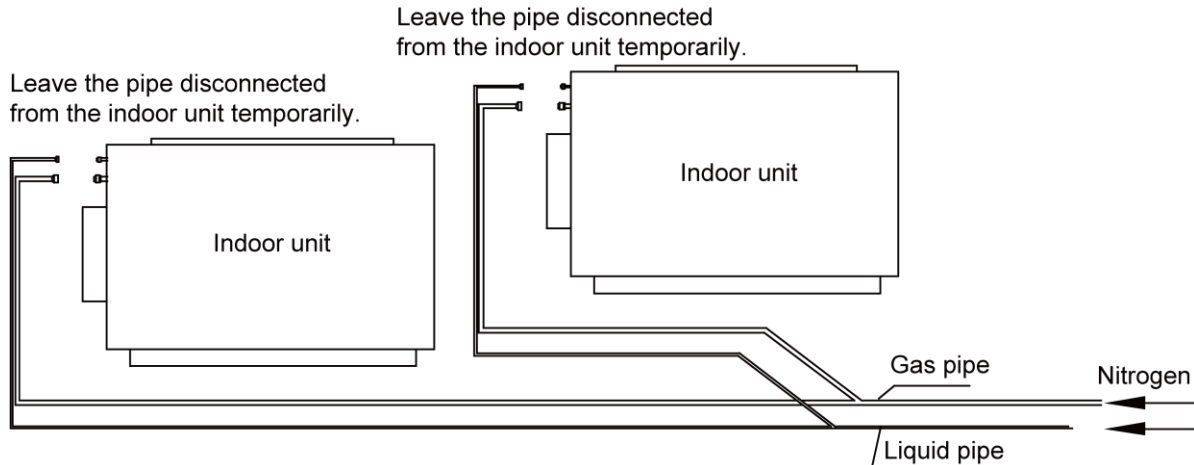

Perform an air-tightness test and a vacuum test to the entire refrigerant pipe system after the construction is finished.

There must be a secure distance between pipes. Pipes in different types must be fixed separately.

**▲ CAUTION**

- When all of the pipes of indoor unit finish welding, dry nitrogen must be used to blow and clean the pipes. Otherwise, the remaining substance in pipeline will cause blockage or leakage to the system (e.g. electronic expansion valve), which result in abnormal operation or even damage the compressor.

6.1.3.8 During refrigerant pipe installation, ensure a distance above 500 mm (19.7inch) between the pipe and the electric box of the unit for maintenance. In a case when the space is not enough, the final piping way must be determined by the technical personnel.

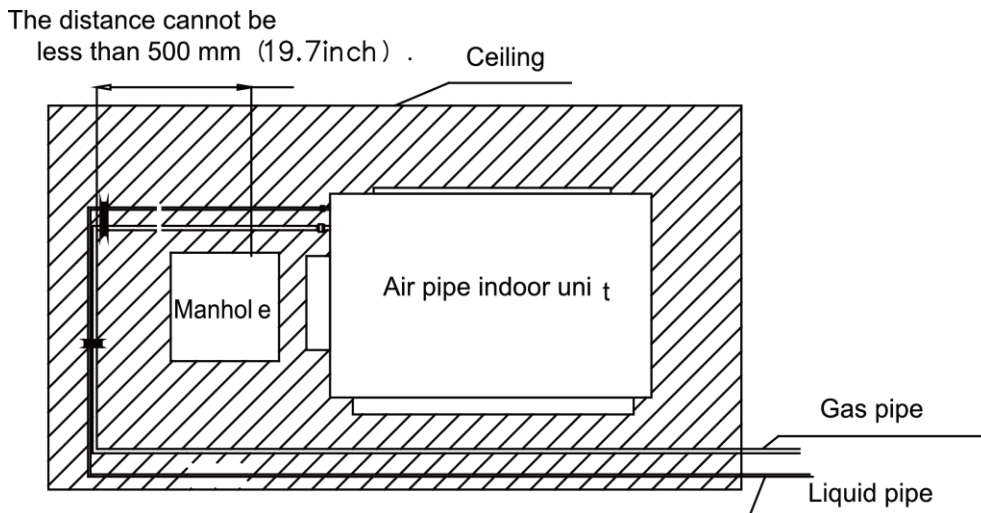

## ▲WARNING

- When installing and moving the air conditioner to another site, be sure to make recharge refrigerant after perfect evacuation.

As the piping for the VRF system is complex, it is recommended that a filter is installed for the gas pipe and a drier is installed for the liquid pipe during construction. This ensures aridity and cleanness of the piping system and further improves the operation stability of the system.

The procedure is as follows:

First, weld a stop valve with the corresponding caliber to the gas pipe and liquid pipe at the position relatively close to the ODU and easy for operation.

Second, install a filter (100 mesh/ft<sup>2</sup>) between the added stop valve outside the gas pipe and the stop valve of the ODU. Then install a drier filter between the added stop valve outside the liquid pipe and the stop valve of the ODU.

Lastly, after the test run is complete,

To remove the filter from the gas pipe after starting all IDUs and keeping them running cooling mode for 24 hours: (1) Power off all units. (2) Turn off the two stop valves of the gas pipe. (3) Remove the filter. (4) Short connect with a copper pipe with the same caliber and vacuumize the pipe. (5) Open the two stop valves and keep normal running.

To remove the drier filter from the liquid pipe after starting all IDUs and keeping them running in heating mode for 24 hours: (1) Power off all units. (2) Turn off the two stop valves of the liquid pipe. (3) Remove the drier filter. (4) Short connect with a copper pipe with the same caliber and vacuumize the pipe. (5) Turn on the two stop valves and keep normal running.

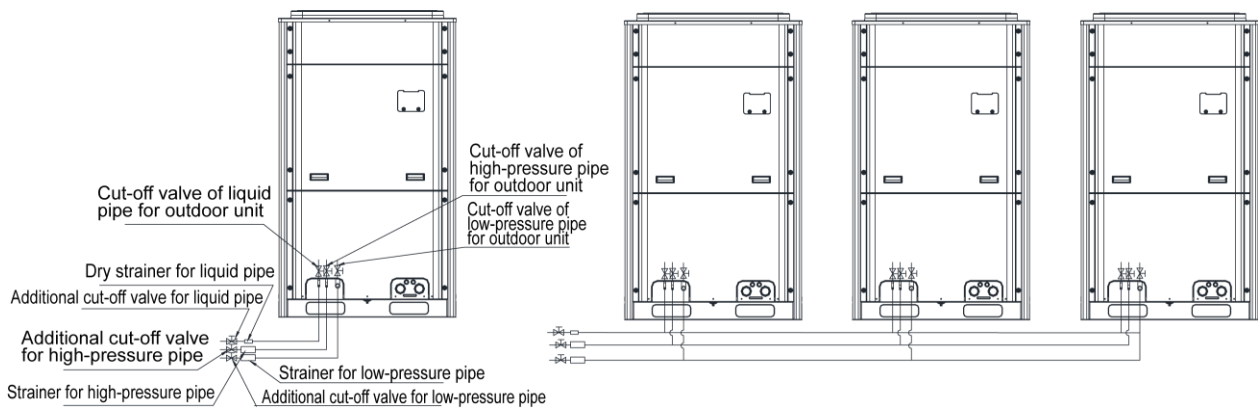

## 6.2 PIPE INSTALLATION FOR THE CONDENSATE WATER SYSTEM

### 6.2.1 Pipes

All of the selected condensate pipes must be consistent with local laws and regulations.

### 6.2.2 Requirements on Installation

- (1) It is not allowed to connect the condensate drain pipe into waste pipe or other pipelines which are likely to produce corrosive or peculiar smell to prevent the smell from entering indoors or corrupt the unit.
- (2) It is not allowed to connect the condensate drain pipe into rain pipe to prevent rain water from pouring in and cause property loss or personal injury.



- (3) Condensate drain pipe should be connected into special drain system for air conditioner.
- (4) Determine the direction and elevation of a condensate water pipe before installing it. Avoid overlapping it with other pipes to ensure straight inclination. The clamp of the pipe hanger is fixed outside the insulation layer. The height of the clamp can be adjusted.
- (5) Distance between Hangers

External Diameter of the Pipe	mm	$\Phi \leq 25.4$	$31.8 > \Phi > 25.4$	$\Phi \geq 31.8$
	In.	$\Phi \leq 1$	$1-1/4 > \Phi > 1$	$\Phi \geq 1-1/4$
Distance between Horizontal Pipes	mm	800	1000	1500
	In.	31-1/2	39-3/8	59
Distance between Vertical Pipes	mm	1500		2000
	In.	59		78-3/4

There are at least two hangers for each vertical pipe.

- (6) The inclination degree of the condensate water pipe must be above 1% and that of the main pipe cannot be lower than 0.3%. Adverse slopes are not allowed.
- (7) When connecting three-way pipes, the two-way straight pipes must be laid on the same slope, as shown in the following figures.

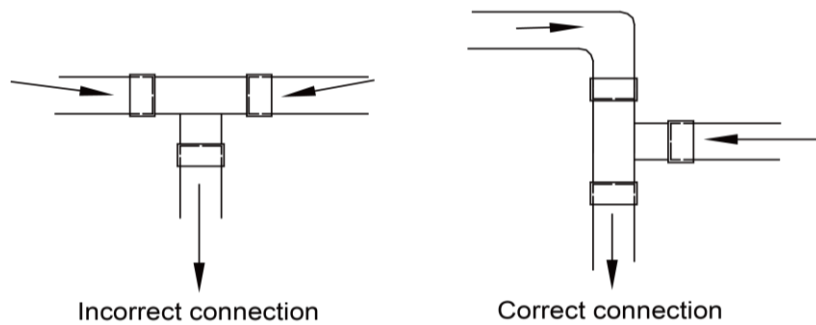

- (8) The condensate water pipe cannot be tied with the refrigerant pipe.
- (9) A ventilation hole must be provided on the top of the drain pipe to ensure smoother discharge of condensate water.
- (10) After pipes are connected, perform a test with some water and another test with full water in the pipe to check whether drainage is smooth and whether water leakage exists in the pipe system.
- (11) Equip a steel casing for all pipes which are led through the wall or floor. Pipe bonding joints cannot be placed inside the sleeve. The steel casing must be parallel with the bottom of the floor or wall. There must be a height drop of 20 mm (0.79inch) from the ground when the pipe is lead through the floor. The sleeve cannot affect the inclination degree of the pipe. Fill the gap between the pipe and the sleeve with flexible and non-flammable materials. The sleeve cannot be used as a support point of the pipe.
- (12) Bond the insulation material joints with special glue and then wrap them with plastic adhesive tape. The width of the adhesive tape must be 50mm (1.97inch) or more to prevent dewing.

### 6.2.3 Other Requirements

- (1) Ensure an inclination degree of more than 1% when connecting the drain pipe to the IDU.

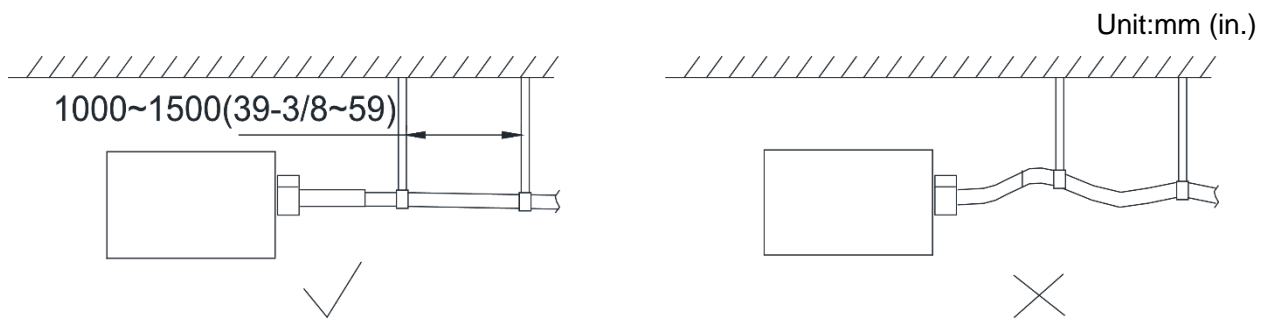

- (2) When connecting the drain pipe to that of the IDU, fix the pipes with the bands provided upon delivery instead of using the glue to facilitate further maintenance.
- (3) When connecting the drain pipe branches to the main pipe, lead through from the above part of the main pipe.
- (4) If the air volume of the IDUs is high and outdoor air resorption may be caused by negative suction pressure, provide a u-type drain trap at the water outlet side of each IDU, as shown in the following figure.

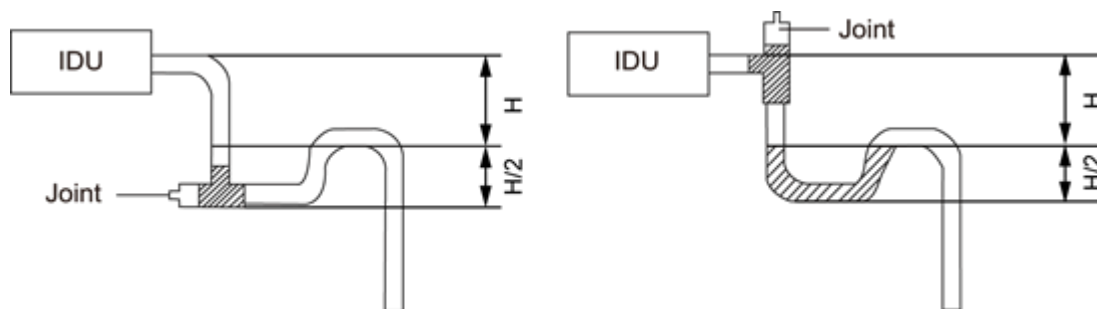

Install drain trap connectors as shown in the following figure.

Install a drain trap connector for each unit.

The drain trap connector shall be installed in a way that facilitates trap cleaning.

- (5) During condensate water pipe installation, ensure a distance above 500mm (19-5/8in.) between the pipe and the electric box of the unit for maintenance. In a case when the space is not enough, the final piping way must be determined by the technical personnel.

### 6.2.4 Requirements on Installation of Drain Pipes for Different Types of IDUs

- (1) Drain Pipe Installation for Hidden Air-duct-type IDU for Air Supply

- 1) Ensure an inclination degree of greater than 1% when connecting the drain pipe to the IDU.
- 2) When connecting the drain pipe to that of the IDU, fix the pipes with the bands instead of using the glue to facilitate further maintenance.
- 3) There is a condensate water outlet on both sides of the IDU. After one condensate water outlet is determined, use the rubber stopper to block the other outlet. Tie it with threads and strap with insulation materials to prevent leakage.
- 4) The connection between the drain pipe and that of the IDU is shown in the following figure.

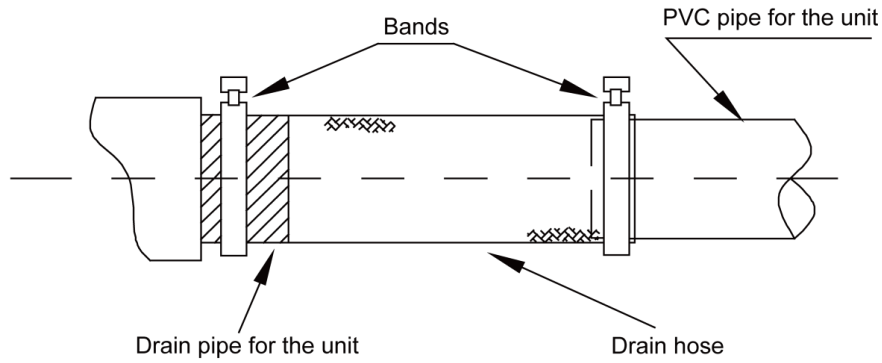

5) Apply insulation materials to the condensate water pipe joints to prevent dewing. d. Insulation for connection between the drain pipe and that of the IDU is shown in the following figure.

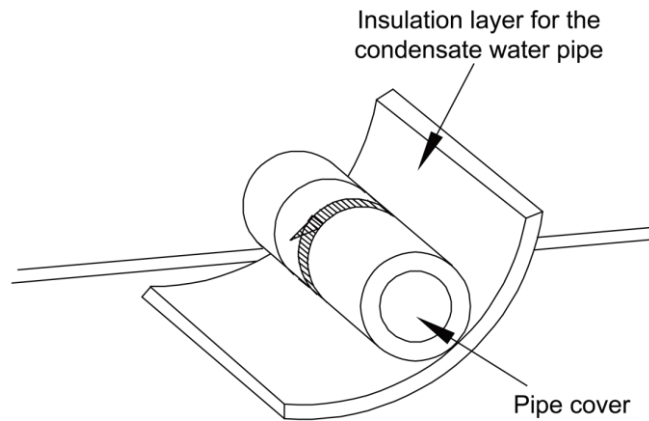

(2) Drain Pipe Installation for IDU

- 1) Use pipe clips instead of applying glue to connect the hoses provided upon delivery and plastic pipes on the device. Connect the other end of the joint to the elbow. The height from the suction inlet of the discharge pump is about 200mm (7-7/8in.) to 500 mm (19-5/8in.). Ensure a proper inclination degree while connecting to the main drain pipe.
- 2) The lifting pipe for drainage must be provided as shown in the following figure.

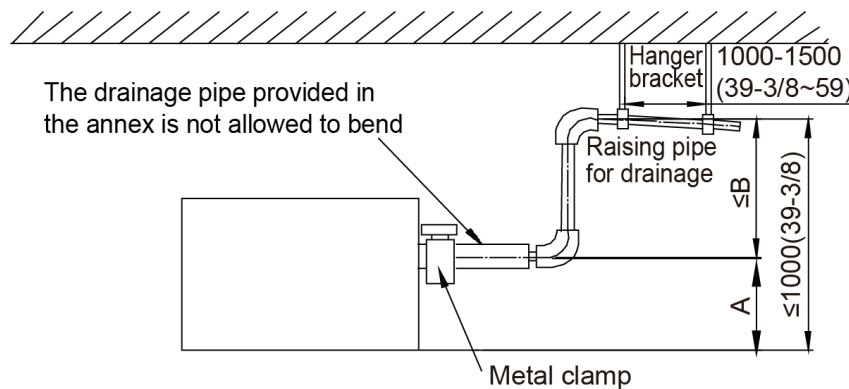

3) The drain pump shall be fixed securely. Otherwise, abnormal noises will be generated.

### 6.3. Requirements on Independent Drainage for Each IDU

Requirements on independent drainage design for each IDU are as follows:

- (1) There must be a proper inclination for the drain pipe.
- (2) The drain pipe must be installed to facilitate drainage to the largest extent and be as short as possible.
- (3) If the water is discharged to the outdoor side, it cannot drop to the outdoor ground directly.

## 6.4. Requirements on Centralized Drainage for IDUs

- (1) When there are multiple IDUs in the same building, centralized drainage is adopted.
- (2) When a header pipe is used, the drain pipe of each IDU must be higher than the header pipe.
- (3) The diameter of the header pipe must be determined on the number and capacity of IDUs.
- (4) When installing pipe, start from the highest point of the pipe and follow the specified inclination to smoothly discharge condensate water.
- (5) Connect branches to the main pipe from the upper part or side instead of lower part of the main pipe.
- (6) Insulate all condensate water pipes, especially for joints at elbows.

### 6.4.1 INSULATION SYSTEM

#### 6.4.1.1 Insulation for the Refrigerant Pipe System

##### 6.4.1.1.1 Insulation Materials

Use closed-cell foam insulation materials with flame retardant grade of B1.

The heat conductivity is not greater than 0.035 w/ (m·k) when the average temperature is 0°C.

##### 6.4.1.1.2 Thickness of the Insulation Layer

External Diameter of the Pipe	mm	≤ 12.7	≥ 15.9
	In.	1/2	5/8
Thickness of the Insulation Layer	mm	≥ 15	≥ 20
	In.	5/8	3/4

Use sunblock, anti-weathering, and non-cracking insulation materials for outdoor pipes.

##### 6.4.1.1.3 Procedure of Insulation

- (1) Select insulation materials based on design requirements.
- (2) Wear the insulation sleeve before connecting refrigerant pipes. Users cannot cut the insulation material apart and then wrap up with ties after connecting the pipes by welding.
- (3) Specifications of the insulation sleeve must match with that of the refrigerant pipes.
- (4) Reserve a distance of about 200 mm (7.87inch) near the welding point to protect the insulation sleeve during welding. After performing the air-tightness test, perform insulation to the welding point separately to ensure continuity of the insulation sleeve.
- (5) The insulation layer cannot crack during construction. Bond the insulation material joints with special glue and then wrap them with electrical adhesive tape. The width of the adhesive tape must be 50 mm (1.97inch) or more to ensure secure connection.
- (6) Use glue to bond the insulation material at the water outlet to the unit to prevent dewing.
- (7) Wrap joints of indoor/outdoor units with insulation materials. There must be no gap between the joint and the wall of the indoor/outdoor unit, as shown in the following figure.

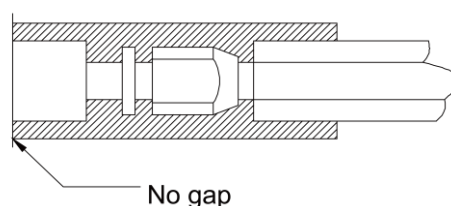

## 6.4.2 Insulation for the Condensate Water Pipe System

### 6.4.2.1 Thickness of the Insulation Layer

Thickness of the insulation layer for the condensate water pipe must be greater than 10 mm (0.39inch).

6.4.2.2 Bond the insulation material joints with special glue and then wrap them with plastic adhesive. The width of the adhesive must be greater than 50mm (1.97inch) to prevent dewing.

6.4.2.3 Insulation is not required for the outdoor part of condensate water pipes.

## 6.4.3 Insulation for Air Ducts

6.4.3.1 Insulation for air duct components and devices must be performed after the air leakage test is performed or after quality check.

6.4.3.2 Use centrifugal glass wool or rubber and plastic materials for insulation or use novel insulation air ducts.

6.4.3.4 The insulation layer should be flat and tight without any crack or gap.

### 6.4.3.5 Thickness of the Insulation Layer

For the air supply and return air pipe laid in a room without an air conditioner, thickness of the rubber and plastic insulation layer is 35 mm (1.38inch).

For the air supply and return air pipe laid in an air conditioning room, thickness of the rubber and plastic insulation layer is 20 mm (0.79inch).

6.4.3.6 Supports, hangers, and brackets of the air duct must be installed outside the insulation layer. A chock must be provided between the support, hanger, or brackets and the air duct.

# 7 ELECTRIC AND CONTROLLER INSTALLATION

## **▲WARNING**

- Follow ordinance of your governmental organization for technical standard related to electrical equipment, wiring regulations and guidance of each electric power company.
- Make sure to use specified wires for connections so that no external force is imparted to terminal connections. If connections are not fixed firmly, it may cause heating or fire.
- Make sure to use the appropriate type of overcurrent protection switch. Note that generated overcurrent may include some amount of direct current.

## **▲CAUTION**

- Some installation site may require attachment of an earth leakage breaker. If no earth leakage

breaker is installed, it may cause an electric shock.

- Do not use anything other than breaker and fuse with correct capacity. Using fuse and wire or copper wire with too large capacity may cause a malfunction of unit or fire.

## 7.1 PRECAUTIONS



- Both the power cable and communication cable must be connected properly. If the power cable is connected to the communication port, the main board will be burnt.

The power cable and communication cable can be identified in the following ways:

Method 1: Use sheaths in different colours.

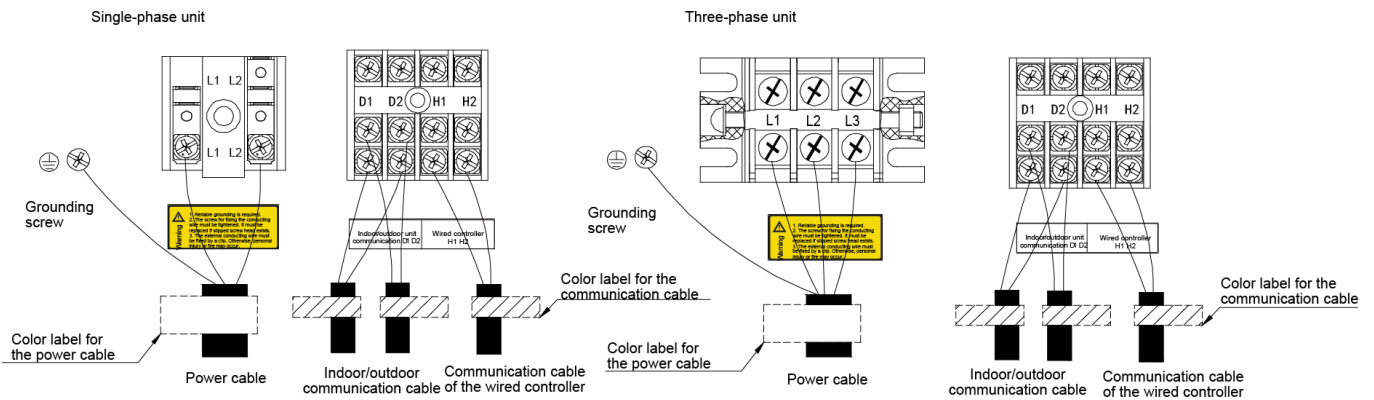

Method 2: Use different types of cables.

The diameter of the power cable is larger than that of the communication cable. Alternatively, adopt three cores or more for the power cable and two cores for the communication cable.

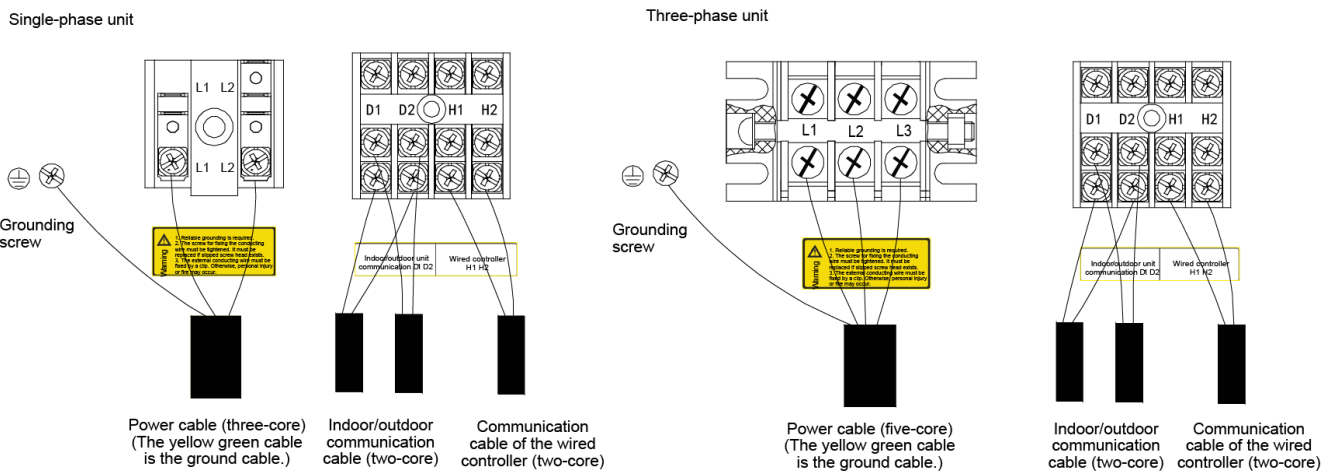

Elaborate the method with the installation personnel on site no matter which method is adopted.

## 7.2 INSTALLATION OF THE POWER CABLE

### 7.2.1 Precautions

- (1) The air conditioning unit is category 1 electrical appliance which requires reliable grounding.

#### **▲WARNING**

- Be sure to have authorized electrical engineers do the electric work using special circuits in accordance with regulations and this installation manual. If power supply circuit has a lack of capacity or electric work deficiency, it may cause an electric shock or fire.

- (2) The grounding resistance must comply with local rules and regulations.

#### **▲CAUTION**

- Be sure to correct the outdoor unit to earth. Do not connect earth line to any gas pipe, liquid pipe, lightning rod or telephone earth line. If earth is incomplete, it may cause an electric shock.

- (3) The yellow green cable inside the air conditioning unit is a grounding cable. It cannot be used for other purposes or be cut off. Do not fix it with tapping screws. Otherwise, an electric shock may be caused.

- (4) A reliable ground terminal must be provided for the power. Do not connect the grounding cable to any of the following:

a). Water pipes   b). Gas pipes   c). Drainage pipe   d). Other places deemed as unreliable

- (5) The power cable and the communication cable must be laid separately with a distance of greater than 200mm (7.87inch). Otherwise, the communication of the unit will be affection.

#### **▲CAUTION**

- Power cable and communication cable cannot come across and they should be at least 200mm (7.87 inch) away from each other, otherwise, unit may work abnormally.

## 7.2.2 Requirements on Power Cable Configuration

Configure a circuit breaker to each unit for short circuit and overload protection. In addition, configure a general circuit breaker to both the indoor and ODU to switch on or switch off the general power of the IDU or ODU.

### (1) External Connection for Individual Units

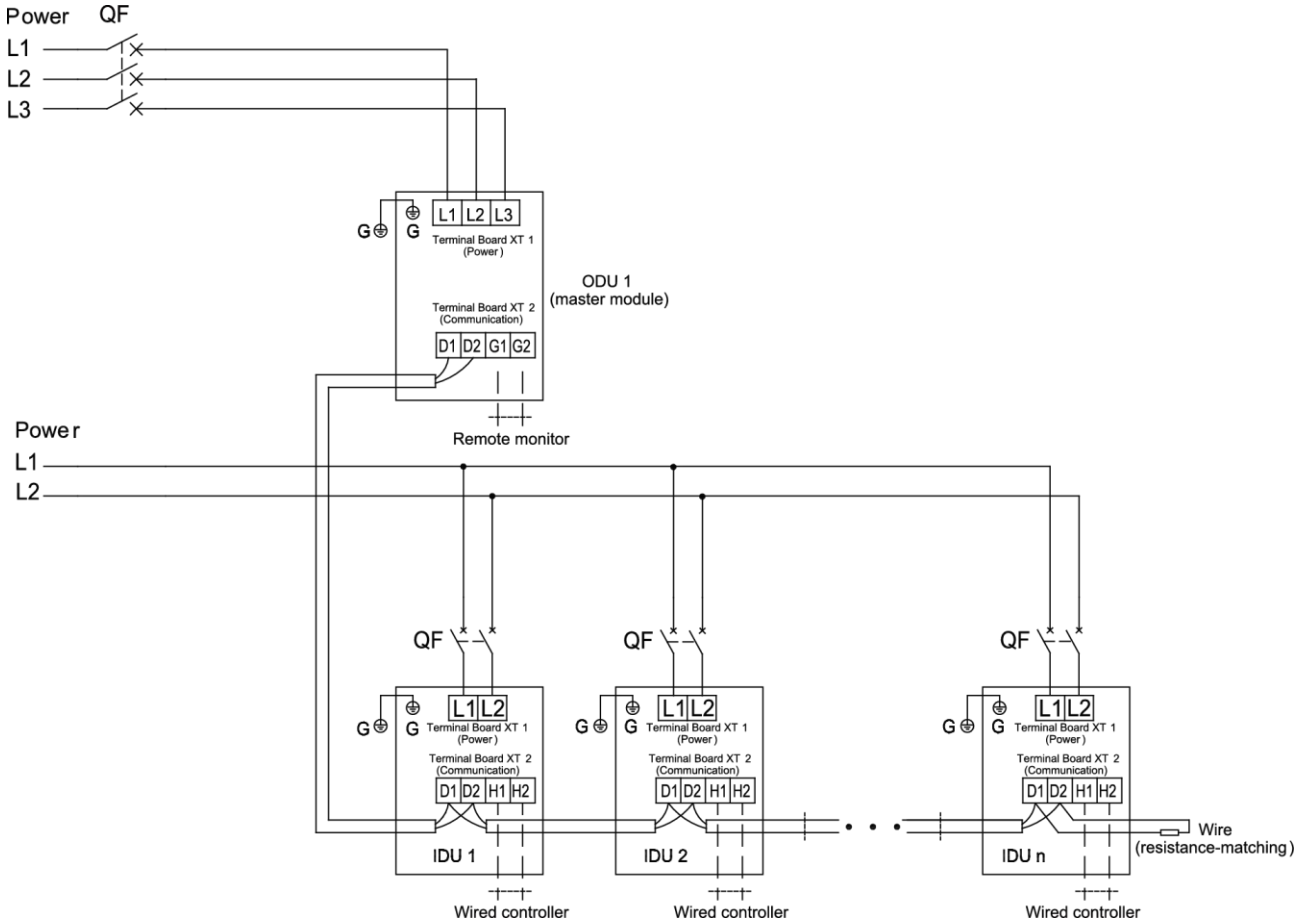

## WARNING

- Indoor Unit ground Lines are required for preventing electrical shock accident during current leakage, Communication disorder by noise effect and motor current leakage (without connection to pipe).
- Don't install an individual switch or electrical outlet to disconnect each of indoor unit separately from the power supply.
- Install the main switch that can interrupt all the power sources in an integrated manner because this system consists of the equipment utilizing the multiple power sources.
- If there exists the possibility of reversed phase, lose phase, momentary blackout or the power goes on and off while the product is operating, attach a reversed phase protection circuit locally. Running the product in reversed phase may break the compressor and other parts.

### NOTE:

The maximum number of connected IDUs (n) is determined based on the capacity of the ODU. For details, see the description on unit capacity configuration.



## (2) External Connection for Modularly Connected Units

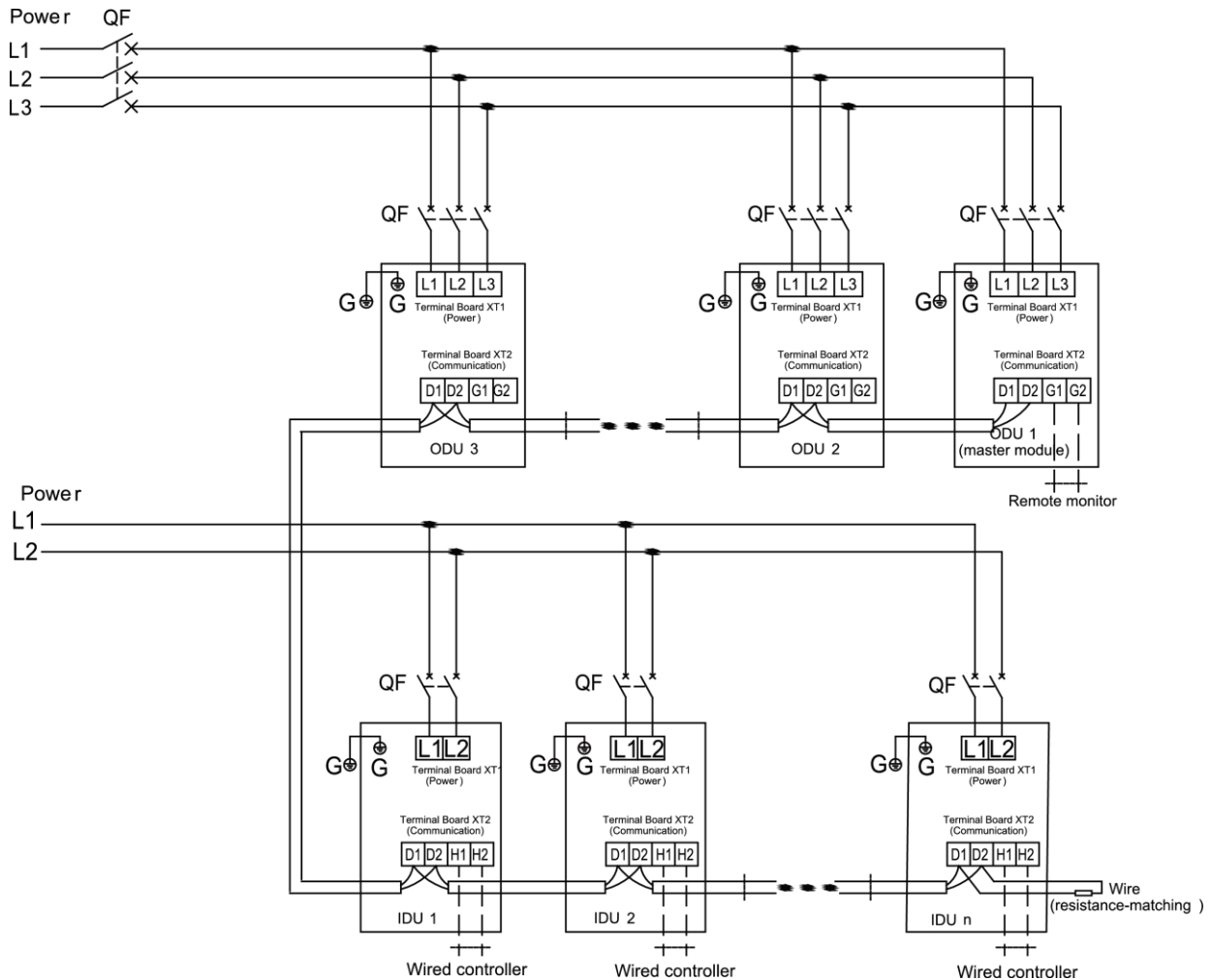

## ▲WARNING

- Indoor Unit ground Lines are required for preventing electrical shock accident during current leakage, Communication disorder by noise effect and motor current leakage (without connection to pipe).

- Don't install an individual switch or electrical outlet to disconnect each of indoor unit separately from the power supply.

- Install the main switch that can interrupt all the power sources in an integrated manner because this system consists of the equipment utilizing the multiple power sources.

- If there exists the possibility of reversed phase, lose phase, momentary blackout or the power goes on and off while the product is operating, attach a reversed phase protection circuit locally. Running the product in reversed phase may break the compressor and other parts.

**NOTE:**

The maximum number of connected ODUs (N) and that of connected IDUs (n) are determined based on the combination form of ODUs. For details, see the description on unit capacity configuration.

### 7.2.3 Procedure for Installing the Power Cable

- (1) Knock off the knockouts used for threading the external power cable, fit the threading rubber ring to the hole, and thread the power cable through the hole. Connect L1, L2, L3, of the power cable, and the grounding cable to L1, L2, L3, on the power terminal block and the grounding screw next to the terminal block respectively.

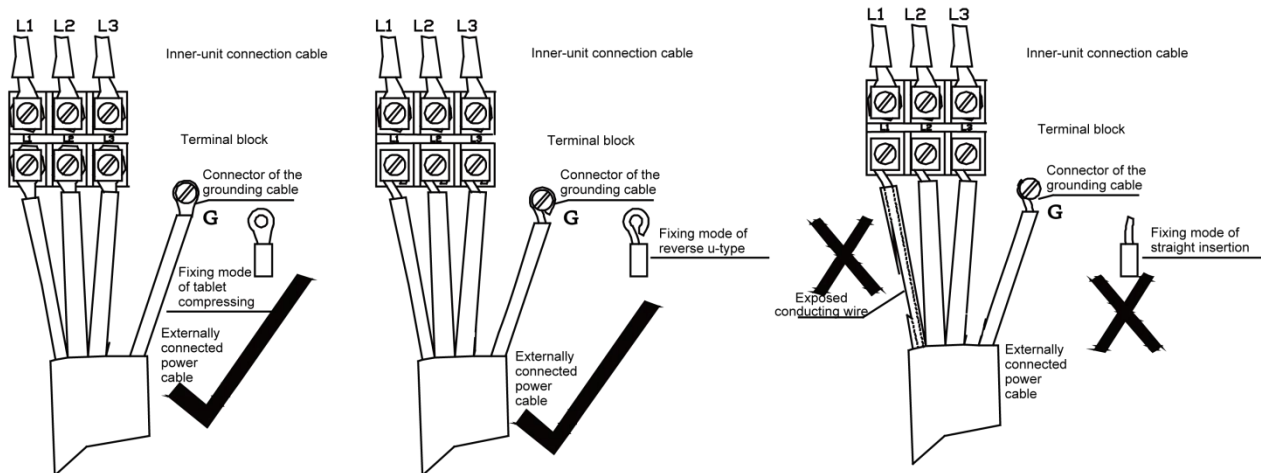

- (2) Fasten and fix the power cable with ties (support heads).
- (3) Lay the power cable and communication cable for the ODU according to the marker of external connection circuit diagram.

**NOTICE!** Provide a threading rubber ring when threading a strong power cable or a communication cable.

### 7.3 INSTALLATION OF THE COMMUNICATION SYSTEM

The CAN communication network is adopted for GMV5 VRF system. Manual DIP or identification on polarities of the communication power is not required for the IDU. Only the function DIP needs to be set for the ODU. For details, see the description on function setting of the ODU.

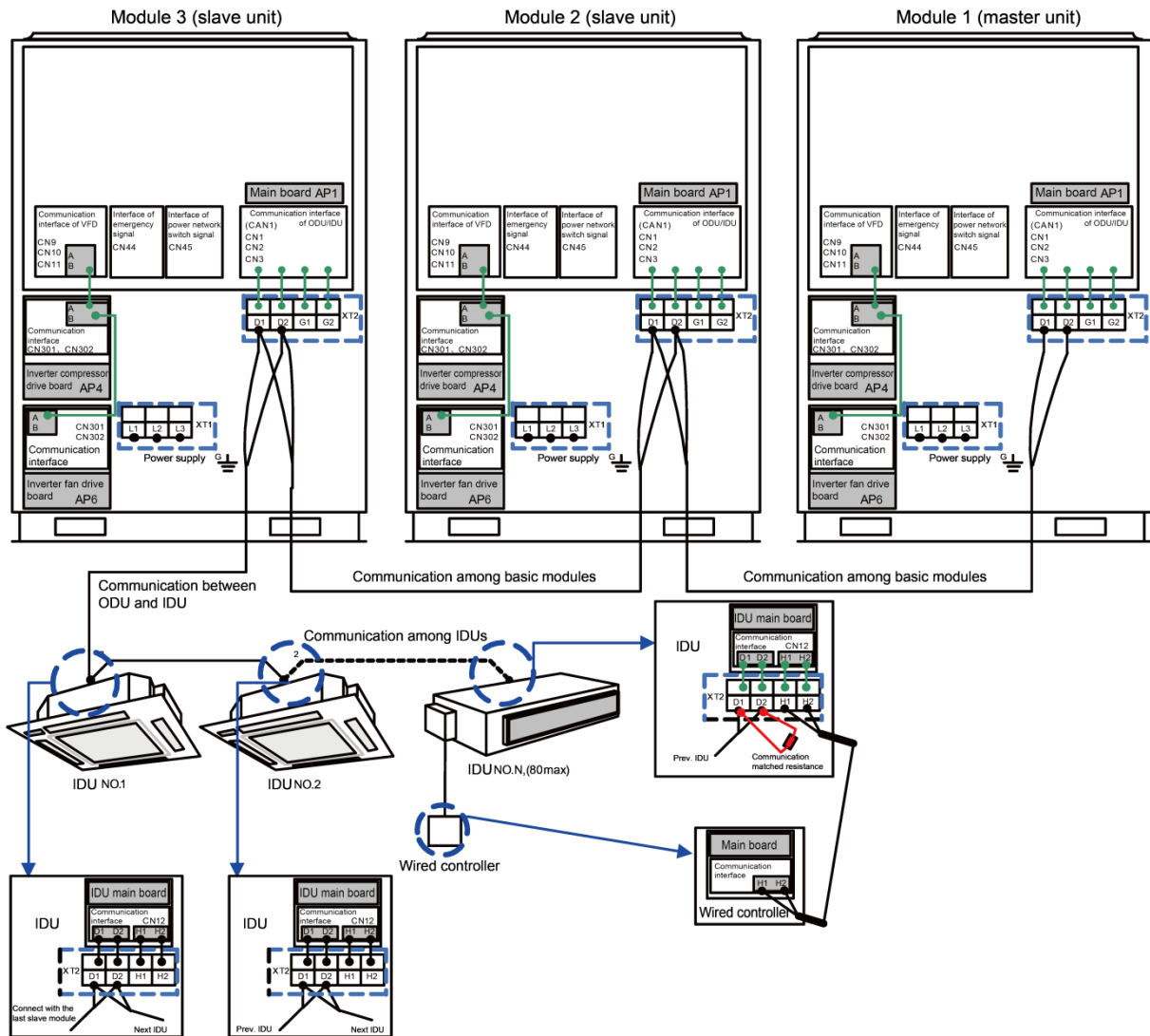

#### 7.3.1 Connection of Communication Cable Terminals

All connections for communication of GMV5 are fastened by screws.

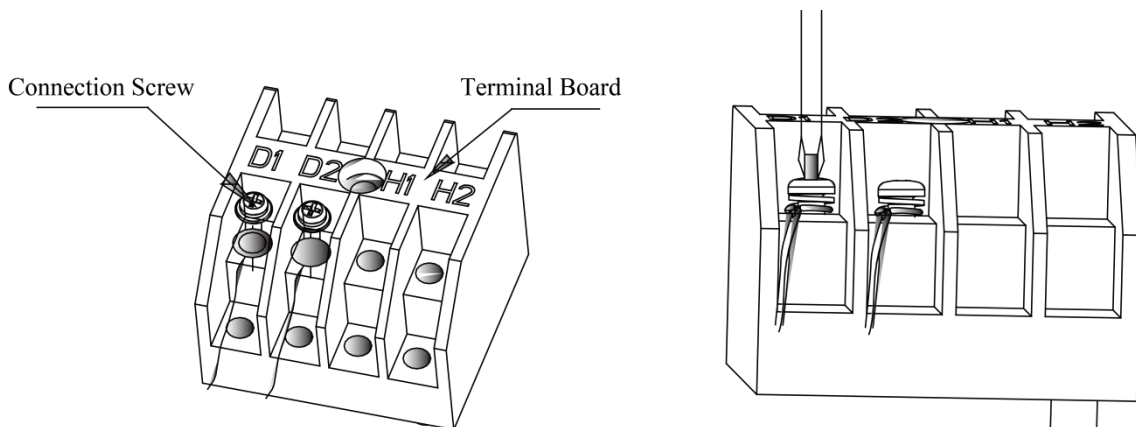

### 7.3.2 Connection of Communication Cables

The communication bus of indoor and ODUs must be connected in series instead of in star mode. The last IDU of the bus shall be connected to a matching resistor (placed in the package of the ODU).

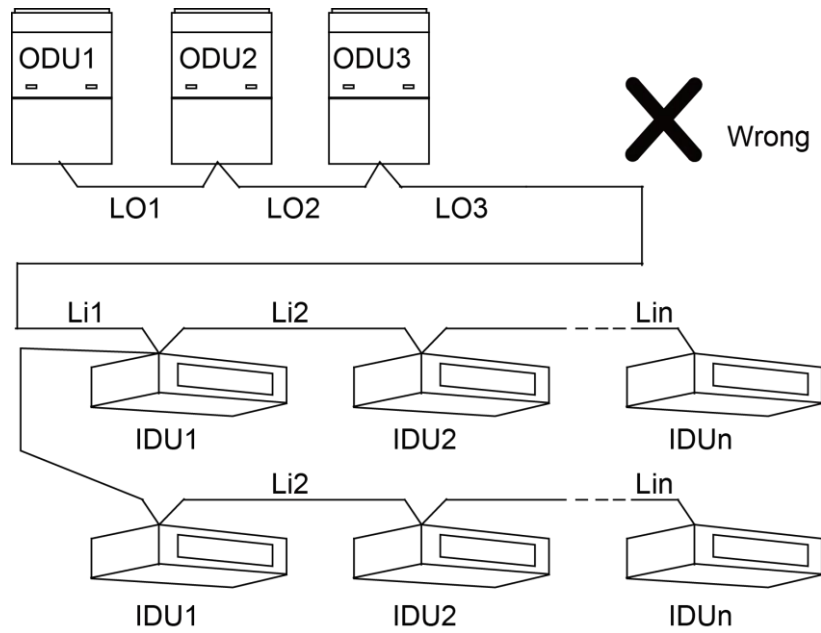
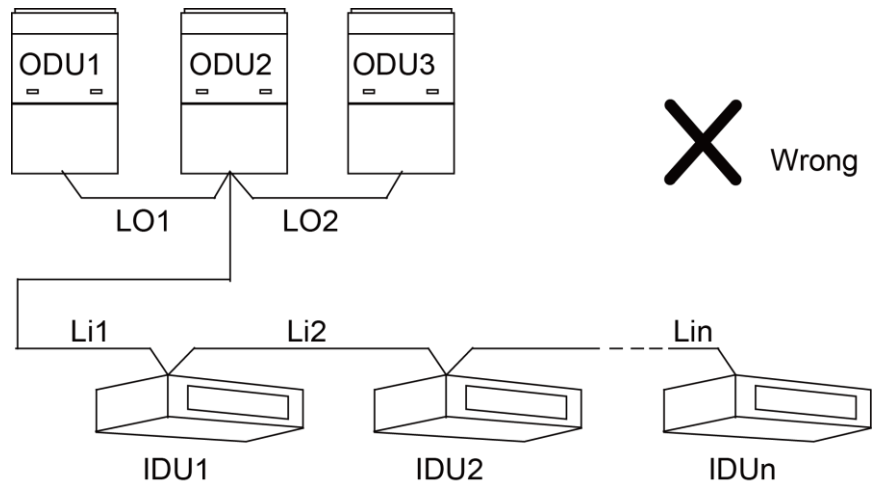
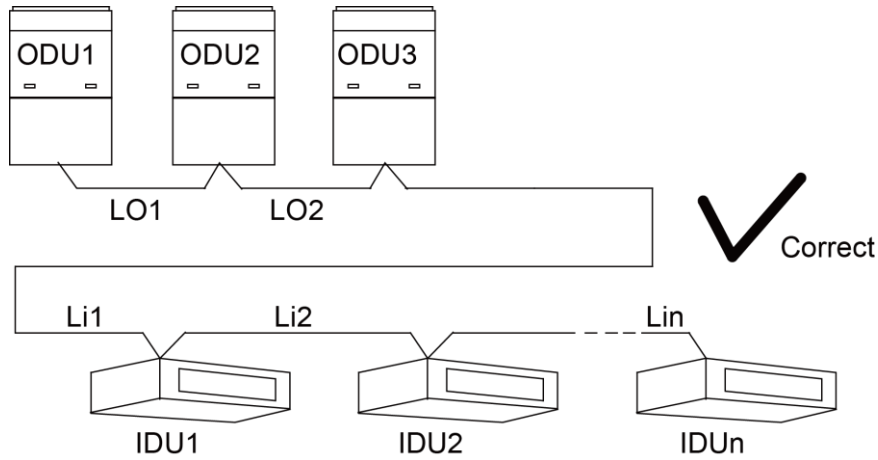

### 7.3.3 Communication Cable Connection Method and Procedure

#### 7.3.3.1 Communication cable connection between the IDUs and ODUs

The communication cable between the IDUs and ODUs is connected via interface D1/D2 on the terminal block XT2. Connection modes for the single-module system and multi-module system are shown in the following figures.

Communication cable connection for the single-module system:

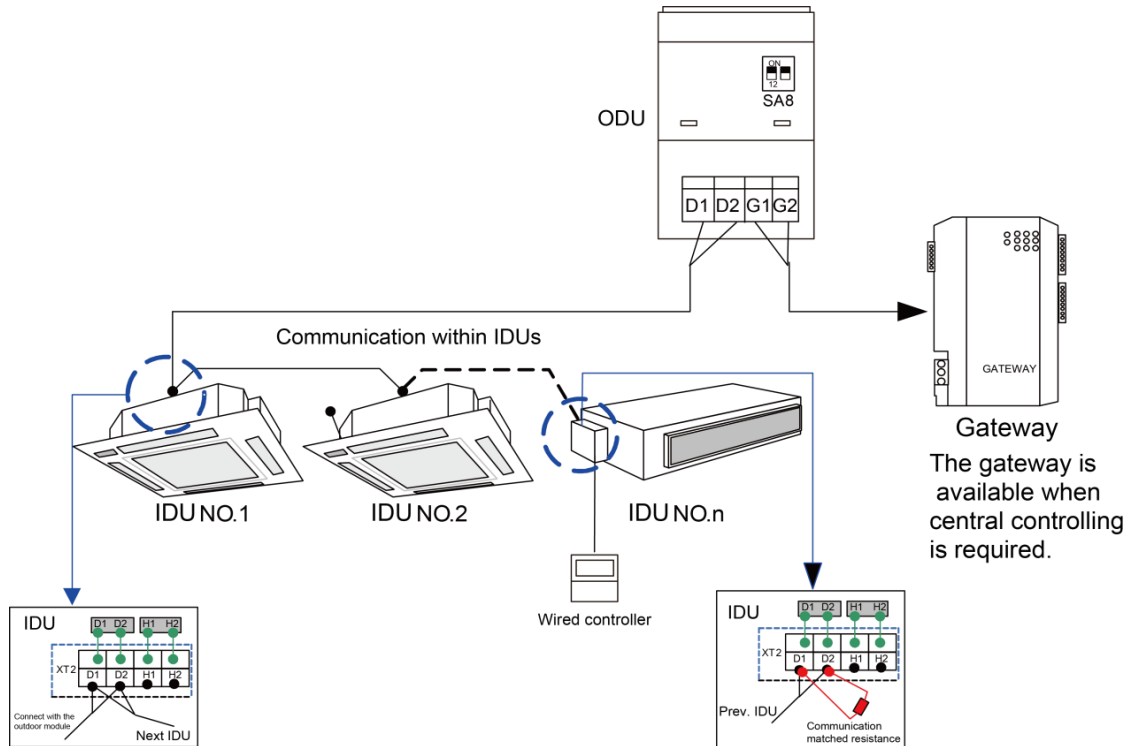

Communication cable connection for the multi-module system:

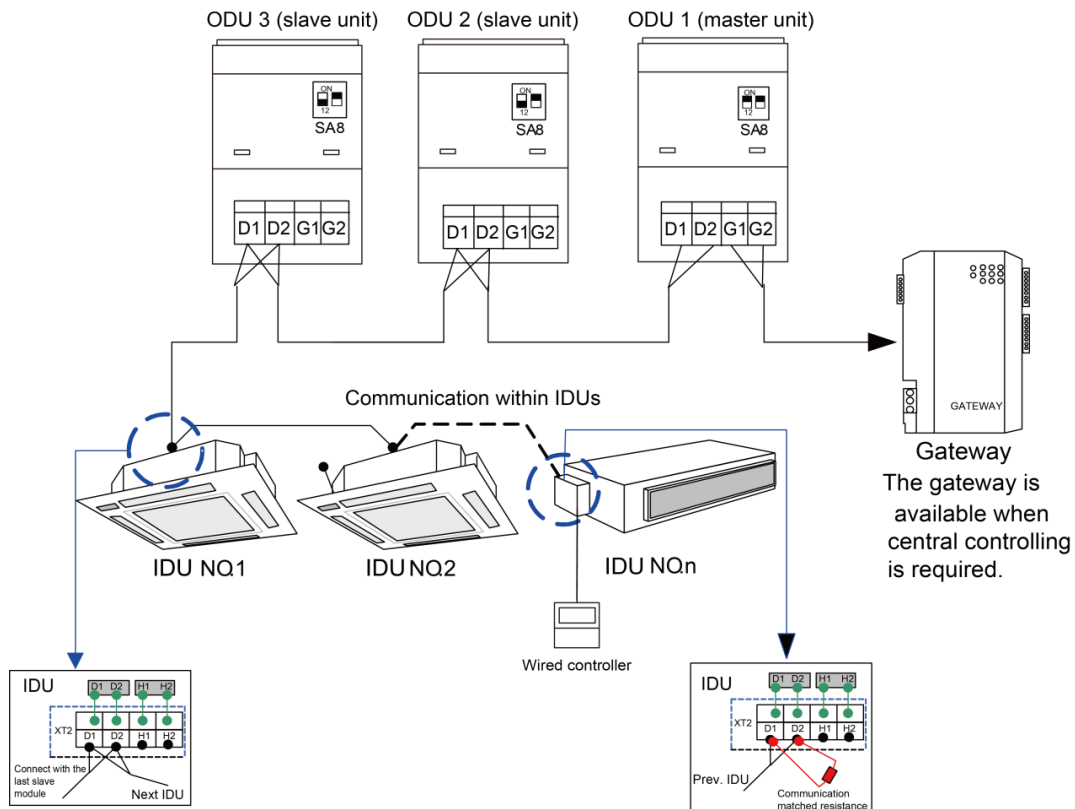

**NOTICE!**

- ① If there are multiple modules for the modular ODU, the master unit must be the first ODU module on the communication cable and cannot be connected to the IDU. (The master unit is set by SA8 on the main board of the ODU.)
- ② If there are multiple modules for the modular ODU, the IDU must be connected to the slave module of the last ODU. (The slave unit is set by SA8 on the main board of the ODU.)
- ③ The communication cable and power cable must be laid separately to avoid interference.
- ④ The communication cable must be long enough to avoid joints.
- ⑤ Indoor units must be connected in series. The last IDU shall be connected to a matching resistor (placed in the package of the ODU).

### 7.3.3.2 Communication cable connection between the IDU and wired controller

Connection modes for the communication cable between the IDU and wired controller are shown in the following figures.

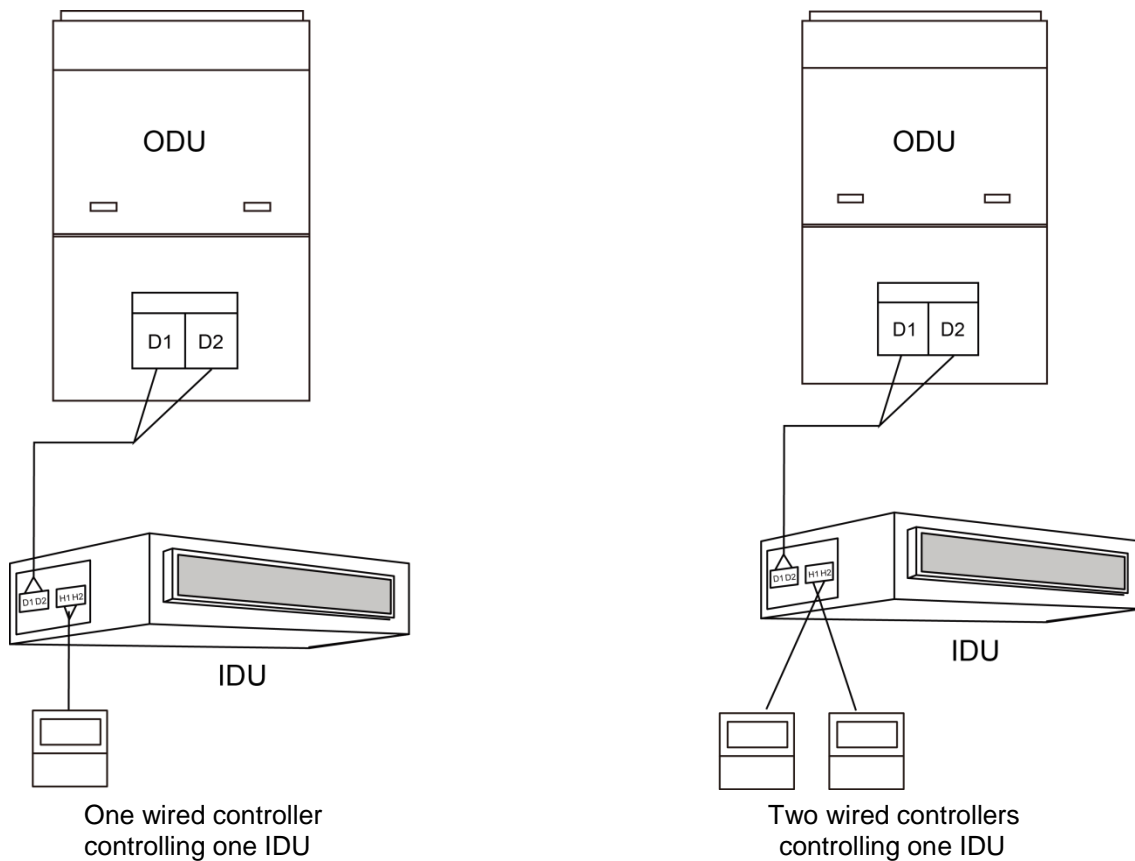

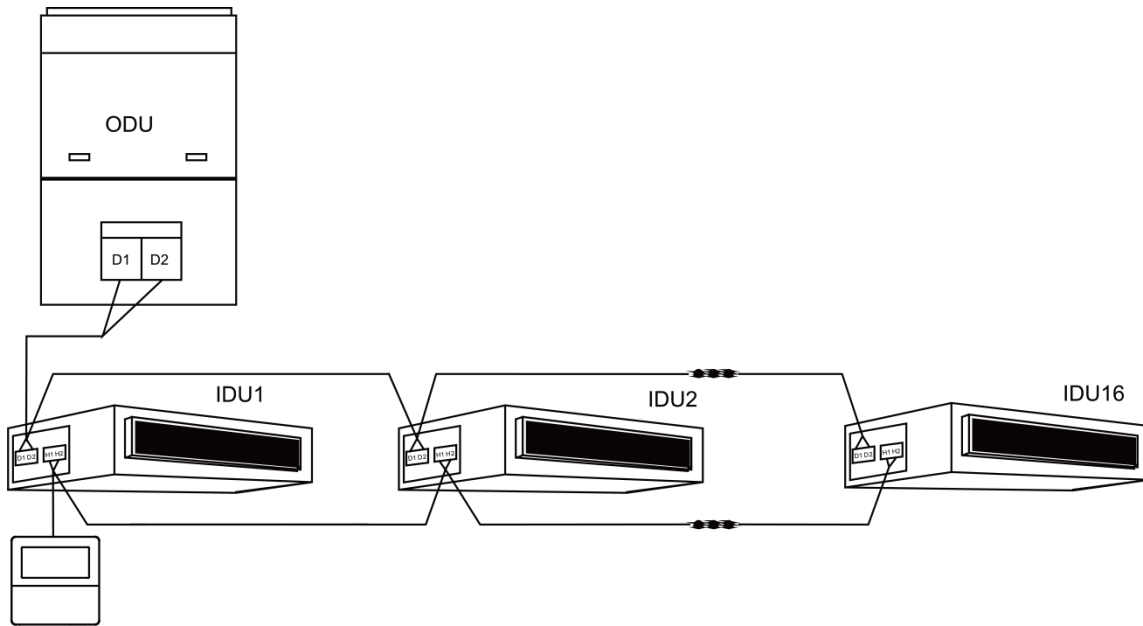

One wired controller controlling multiple IDUs

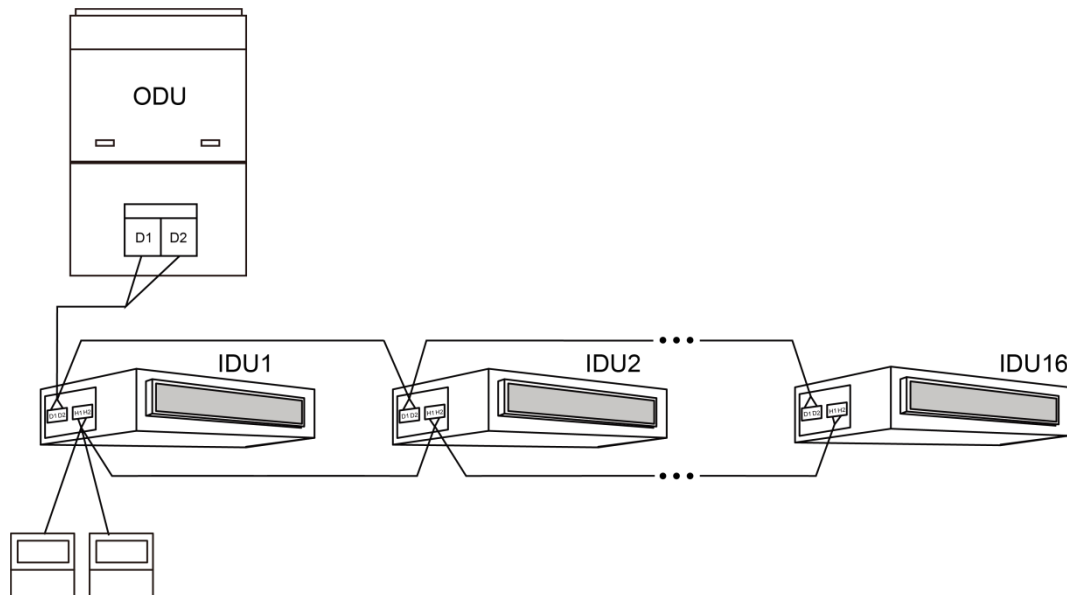

Two wired controllers controlling multiple IDUs

When two wired controllers control multiple IDUs, the wired controller can be connected to any one IDU, provided that the connected IDU is of the same series. Meanwhile, one and only one of the wired controllers must be set as a slave controller. At most 16 IDUs can be controlled by wired controllers and the connected IDUs shall be within a same IDU network.

No matter when unit is turned on or off, slave controller can be set.

How to set a slave controller: hold "function" button on the designated controller for 5s, and temperature zone displays C00. Continue holding "function" button for 5s and setting screen of controller parameter will come out. Default temperature zone displays P00.

Press ▲ button or ▼ button to select parameter code P13. Press "mode" button to switch to setup of parameter values. Then the parameter value will blink. Press ▲ button or ▼ button to select code 02. And then press "confirm/cancel" to finish setting.

Press "confirm/cancel" to return to the previous display until you exit from the setup of parameter values.

Below are user's parameter settings:

Parameter code	Parameter name	Parameter scope	Default value	Remark
P13	Set up address for wired controller	01: master wired controller 02: slave wired controller	01	When 2 wired controllers control one or more IDUs, they shall have different addresses. Slave wired controller (02) can't set up units' parameters except its own address.

Communication connection between duct type IDU and light board receiver

When the duct type IDU needs to be connected to light board remote receiver, it can be connected via DISP1 and DISP2 on the IDU main board.

IDU type	Connection wire	Main board interface of corresponding IDU
Duct type IDU	Between boards (17-core)	DISP1 (direct to 8-core interface) DISP2 (direct to 9-core interface)

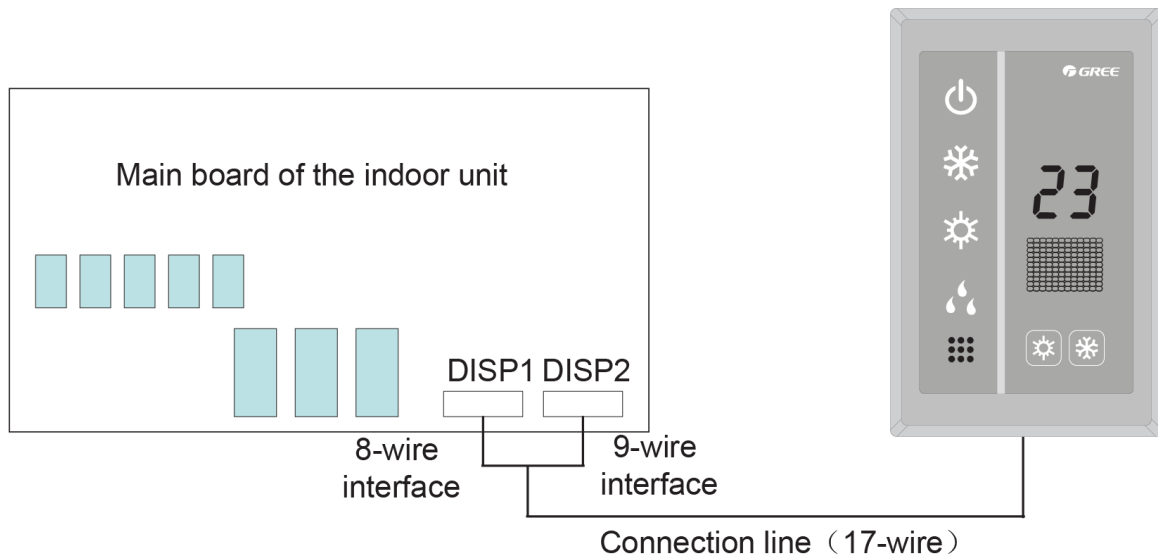

Fig.54

<b>NOTICE</b>
(1) Wired controller and light board remote receiver can be used at the same time.
(2) When light board remote receiver is used, please use remote controller at the same time.



# 8 VACUUMIZATION AND DESICCATION FOR THE REFRIGERANT SYSTEM

Works for the refrigerant system include cleaning and desiccating the pipes, performing an air-tightness test, and perfusing refrigerant.

## 8.1 AIR-TIGHTNESS TEST

### 8.1.1 Importance of the Air-tightness Test

Air-tightness of the multi-module air conditioning system mainly refers to the tightness of the refrigerant pipes, which ensures secure and reliable running of the air conditioner.

Refrigerant leakage may affect functions of the air conditions or even damage the compressor and make the system to break down. Therefore, a air-tightness test must be performed. If refrigerant leakage is detected after the system is installed, it is very difficult to locate the leaking point as the suspending ceiling has been decorated. Therefore, the air-tightness test must be performed before ceiling sealing for indoor decoration is finished.

### 8.1.2 Procedure for Performing the Air-tightness Test

Stop valves of the gas and liquid pipes of the ODU are turned off at delivery.

Before test, apply a small amount of required lubricant on the block nut and pipe terminals and use two wrenches to fix the block nut.

The ODU pipes cannot be connected when the air-tightness test is being performed.

The test pressure for R410A system is 4.0 MPa. Use dry nitrogen as media for the air-tightness test. Increase the pressure slowly by following the steps below:

Step 1: Increase the pressure to 0.5 MPa. Stop for 5 minutes and then perform air-tightness check. Major leakage may be detected.

Step 2: Increase the pressure to 1.5 MPa. Stop for 5 minutes and then perform air-tightness check. Minor leakage may be detected.

Step 3: Increase the pressure for R410A system to 4.15 MPa. Stop for 5 minutes and then perform strength check. Slight leakage or blow holes may be detected. After increasing the pressure to the test pressure, keep the pressure for 24 hours and check whether it decreases. If the pressure does not decrease, it meets the requirement.

### 8.1.3 Precautions

- (1) The measuring range of the test pressure gauge for R410A system must be above 4.5 MPa.
- (2) Record the value displayed on the pressure gauge, ambient temperature, and test time.
- (3) Pressure correction: The pressure changes by 0.01 MPa when the temperature changes by 1°C.
- (4) The pressure meets the requirement if it does not change.
- (5) If the pressure must be kept for a long time, decrease the pressure to 0.5 MPa or lower. High pressure for a long time may cause leakage at the welding point or safety hazard.
- (6) Before performing the air-tightness test to the refrigerant pipes, do not conduct insulation or

wrapping at the welding or flaring opening joints of the IDU. The pressure must be increased simultaneously for pipes on outdoor sides and cannot be increased for pipes on one side.

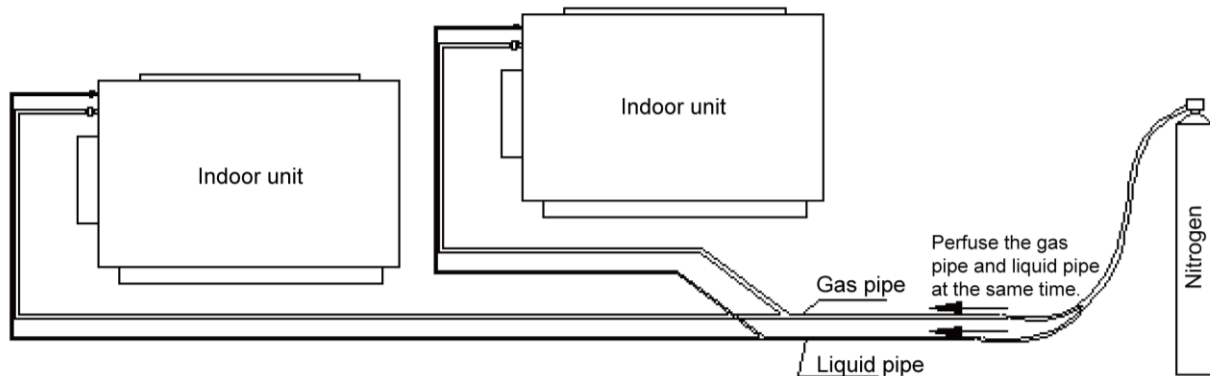

### ▲ CAUTION

- Before performing the air-tightness test, do not conduct insulation or wrapping at the welding joints, Otherwise, leak source cannot be detected quickly.

## 8.2 VACUUMIZATION AND DESICCATION FOR THE SYSTEM

### 8.2.1 Requirements on the Vacuum Pump

The vacuum pump for different refrigerant systems cannot be the same.

The ultimate vacuum degree of the vacuum pump should reach -0.1 Mpa.

The air discharge capacity of the vacuum pump must be greater than 4 L/S.

The precision of the vacuum pump must be greater than 0.02 mmHg.

The system vacuum pump must be equipped with a check valve.

### 8.2.2 Procedure and Precautions for Vacuumization and Desiccation

#### 8.2.2.1 Procedure

- (1) Before vacuumization, ensure that the stop valves of the gas and liquid pipes are turned off.
- (2) Use the perfusing duct to connect the regulator valve and vacuum pump to detection connectors of the gas pipe and liquid pipe.
- (3) Vacuumize for 4 hours and check whether the vacuum degree reaches -0.1 MPa or more. If not, leakage may exist. Perform leakage check again. If no leakage exists, continue to vacuumize for 2 hours.
- (4) If the vacuum degree cannot be kept after vacuumization is performed for twice, there may be water in the pipe when it is confirmed that no leakage exists. In this case, discharge water by means of vacuum breaking. Perfuse nitrogen at 0.05 MPa to the pipe. Vacuumize for 2 hours and keep vacuuming for 1 hour. If the vacuum degree of -0.1 MPa cannot be reached, repeat this operation till water is discharged.
- (5) After vacuumization, turn off the regulator valve and keep for 1 hour. Ensure that the pressure of the regulator valve does not increase.

8.2.2.2 Precautions:

(1) The gas pipe and liquid pipe must be vacuumized at the same time.

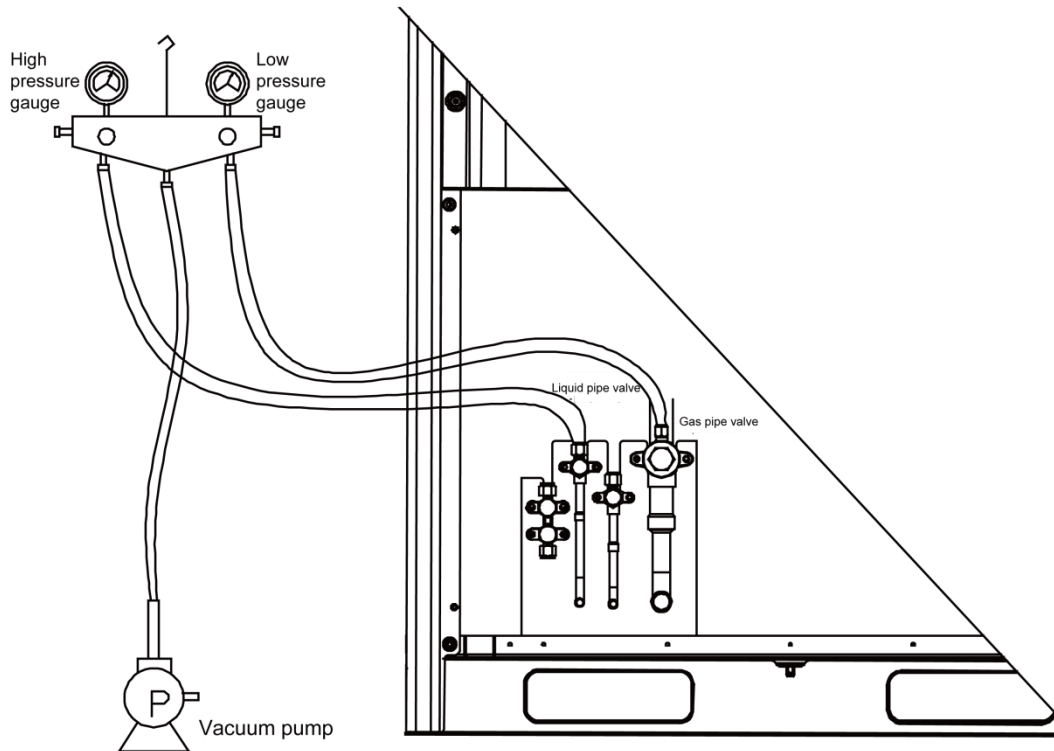

- (2) Turn off the valve before powering off the vacuum pump.
- (3) Keep vacuuming for 2 hours. The vacuum meets the requirement if the pressure displayed by the vacuum gauge does not increase.
- (4) The units parallel connected to the module and oil-equalizing pipe also need to be vacuumized.

# 9 REFRIGERANT PERFUSION

## 9.1 CALCULATION METHOD FOR PERFUSING REFRIGERANT

Outdoor unit has been charged refrigerant before delivery.

Charge additional refrigerant for field-installed connecting pipe. If the pipeline is longer than 1m (39-3/8inch), please refer to the following table for charging amount of refrigerant. (Liquid pipe prevails)

How much additional refrigerant should be charged

Total refrigerant charging amount  $R = \text{Pipeline charging amount } A + \sum \text{charging amount } B \text{ of every module}$

(1) Pipeline charging amount

Added refrigerant quantity  $A \text{ for piping} = \sum \text{Liquid pipe length} \times \text{Added refrigerant quantity for each meter (inch) of liquid pipe}$

	Diameter of liquid pipe							
	mm(inch)							
	28.6(1-1/8)	25.4(1)	22.2(7/8)	19.05(3/4)	15.9(5/8)	12.7(1/2)	9.52(3/8)	6.35(1/4)
kg/m	0.680	0.520	0.350	0.250	0.170	0.110	0.054	0.022
OZ/in.	0.61	0.47	0.31	0.22	0.15	0.10	0.05	0.02

(2)  $\Sigma$ Refrigerant charging amount B of every module

Refrigerant charging amount B of every module kg(Pounds)		Rated Capacity(1000Btu/h)				
IDU/ODU rated capacity collocation ratio C	Quantity of included IDUs(N)	72	96	120	144	168
50% $\leq$ C $\leq$ 90%	N<4	0	0	0	0	1.5(3.3)
	N $\geq$ 4	0.5(1.1)	0.5(1.1)	0.5(1.1)	0.5(1.1)	3.5(7.7)
90%<C $\leq$ 105%	N<4	1(2.2)	1(2.2)	1.5(3.3)	1.5(3.3)	5.5(12.1)
	8>N $\geq$ 4	2(4.4)	2(4.4)	3(6.6)	3(6.6)	6.5(14.3)
	N $\geq$ 8	4(8.8)	3.5(7.7)	4(8.8)	5.5(12.1)	8(17.6)
105%<C $\leq$ 135%	N<4	2(4.4)	2(4.4)	2.5(5.5)	3(6.6)	6.5(14.3)
	8>N $\geq$ 4	4(8.8)	3.5(7.7)	4(8.8)	4.5(9.9)	8(17.6)
	N $\geq$ 8	4.5(9.9)	4.5(9.9)	5(11.0)	6(13.2)	9(19.8)

**CAUTION**

- (1) IDU/ODU rated capacity collocation ratio C = Sum of rated cooling capacity of indoor unit / Sum of rated cooling capacity of outdoor unit.
- (2) If all of the indoor units are fresh air indoor units, the quantity of refrigerant added to each module is 0kg.
- (3) If outdoor air processor is connected with normal VRF indoor unit, adopt the perfusion method for normal indoor unit for perfusion.

**For example1:**

The OUD is composed of 3 modules: 72kBtu/h, 120 kBtu/h and 120 kBtu/h. The IDUs are made up of 7sets of 48 kBtu/h.

IDU/ODU rated capacity collocation ratio C= 48 $\times$ 7/ (72+120+120) =108%.The quantity of included IDUs is more than 4 sets. Please refer to the above table.

Refrigerant charging amount B for 72kBtu/h module is 4.0kg (8.8pounds).

Refrigerant charging amount B for 120 kBtu/h module is 4.0kg (8.8pounds).

Refrigerant charging amount B for 120 kBtu/h module is 4.0kg (8.8pounds).

So,  $\Sigma$  Refrigerant charging amount B of every module=4.0+4.0+4.0=12kg (8.8+8.8+8.8=26.4pounds).

Suppose the Pipeline charging amount A= $\Sigma$  Liquid pipe length  $\times$  refrigerant charging amount of every 1m (or 1in.) liquid pipe=25kg (55.1 pounds)

Total refrigerant charging amount R=25+12=37kg (55.1+26.4=81.5pounds).

**For example 2:**

Outdoor unit is a 72kBtu/h module and the indoor unit is a 72kBtu/h fresh air unit. The quantity (B) of refrigerant added to this module is 0kg (0pounds).

So,  $\Sigma$ B (Quantity of refrigerant added to each module) = 0kg (0pounds).

Suppose that A (Quantity of refrigerant added to connection pipe) =  $\Sigma$  Length of liquid pipe  $\times$

Quantity of refrigerant added to liquid pipe per meter) = 5kg (11pounds).

R (Quantity of added refrigerant in total) = 5+0=5kg (11+0=11pounds).

Modular combination of outdoor unit subjects to combinations that is currently available.

After confirming that there is no leakage from the system, when the compressor is not in operation, charge additional R410A with specified amount to the unit through the filling opening of the liquid pipe valve of the outdoor unit. If required additional refrigerant cannot be quickly filled for increase of pressure in the pipe, set the unit at cooling startup and then fill the refrigerant from gas valve of outdoor unit. If ambient temperature is low, the unit can't be set to cooling mode but heating mode.

### 9.1.1 Precautions on Refrigerant Leakage

- (1) Personnel related to air conditioning engineering design and installation operators must abide by the safety requirement for preventing refrigerant leakage specified in local laws and regulations.
- (2) The units adopt the R410A refrigerant, which is nonflammable and nontoxic. However, the space for refrigerant leakage must be sufficient to ensure that the refrigerant concentration does not exceed that specified in the safety requirement; otherwise, people involved can be stifled by the refrigerant. For example the maximum allowed concentration level of refrigerant to a humanly space for R410A according to the appropriate European Standard is limited to 0.44 kg/m<sup>3</sup>.

The maximum amount of refrigerant (kg) in the system = The volume of the room (m<sup>3</sup>) × The maximum allowed concentration level of refrigerant (kg/m<sup>3</sup>)

Total amount of refrigerant (kg) in the system = Total additional charging amount (kg) + Amount of refrigerant (kg) which is charged before leaving the factory (for the system consisting of multiple modules in parallel, the accumulative charge quantity of modules before leaving the factory is used)

Total amount of refrigerant (kg) in the system ≤ The maximum amount of refrigerant (kg) in the system

- (3) When the total amount of refrigerant in the system is more than the maximum amount of refrigerant, the cooling system should be designed again. In this case, the cooling system can also be separated into several cooling systems with small capacity, or add corresponding ventilation measures or alarming display.

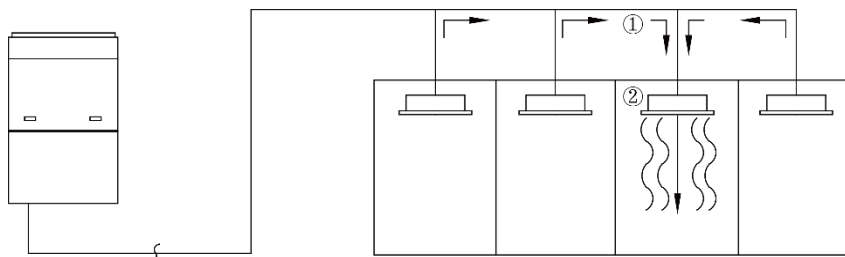

① Flow direction of refrigerant leakage.

② Room for refrigerant leakage. Since the concentration of refrigerant is greater than that of air, pay attention to the spaces where the refrigerant may residue, for example, the basement.

## 9.2 METHOD FOR PERFUSING REFRIGERANT

Refrigerant perfusion for the VRF system is classified into pre-perfusion and perfusion during running.

### 9.2.1 Refrigerant Pre-perfusion

Step 1: Connect the high pressure gauge pipe to the detection opening of the liquid pipe, the low pressure gauge pipe to the detection opening of the gas pipe, and the medium gauge pipe to the vacuum pump. Power on the vacuum pump to perform vacuumization and desiccation.

Step 2: After vacuumization and desiccation are finished, turn off valves of the high pressure gauge and low pressure gauge. Disconnect the medium gauge pipe from the vacuum pump and connect it to the refrigerant tank.

Step 3: Properly loosen the joint between the medium gauge pipe and the pressure gauge and slightly turn on the valve of the refrigerant tank. Vacuumize the medium gauge pipe. After that, fasten the joint and turn on the valve of the refrigerant tank completely.

Step 4: If the refrigerant tank is not equipped with a siphon, reverse the refrigerant tank and place it on the electronic scale. Then record the current weight (m1). If the refrigerant tank is equipped with a siphon, record the current weight (m1) directly.

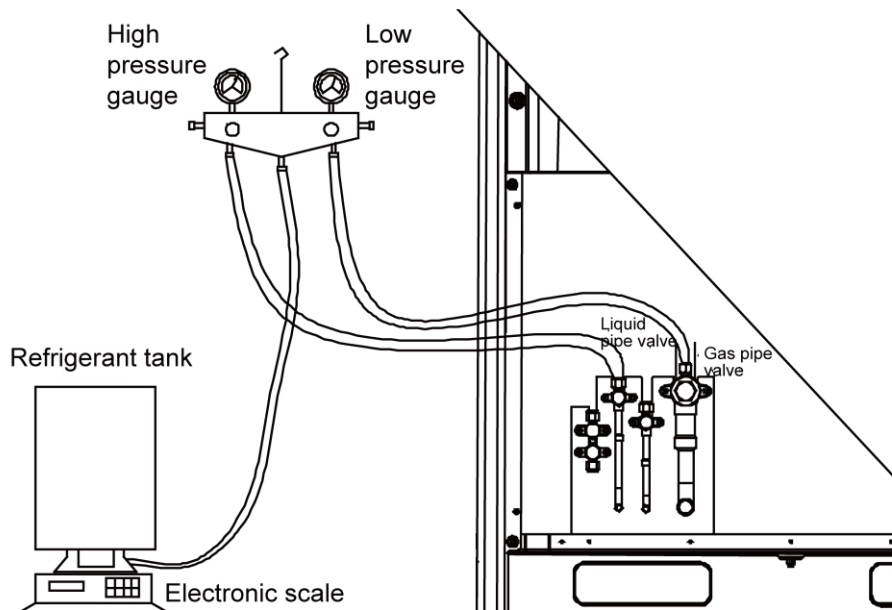

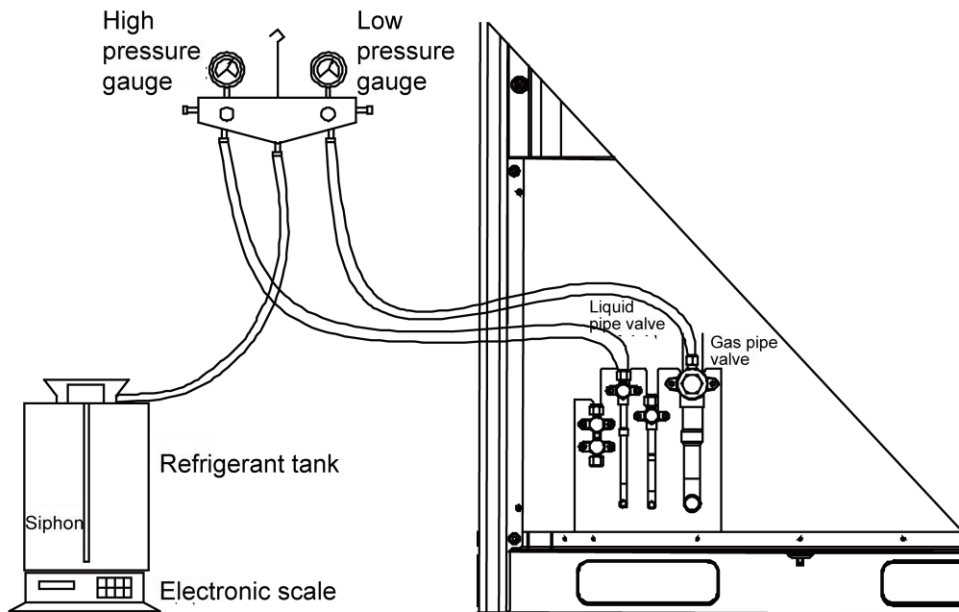

Step 5: Turn on the valve of the high pressure gauge (while keep the valve of the high pressure gauge turned off) and then perfuse refrigerant to the system. Record the change of weight of the refrigerant tank.

Step 6: When all refrigerant in the refrigerant tank is perfused, record the current weight  $m_2$ .

Step 7: Turn off the valve of the high pressure gauge and replace the refrigerant tank.

Step 8: Perform step 3 again.

Step 9: Perform step 5 and step 6 again. Record the weight before perfusion  $m_3$  and weight after perfusion  $m_4$ .

Step 10: If there is no sufficient refrigerant and the calculated quantity of refrigerant is not fulfilled for the system, record the current total perfusion quantity.

$$m = (m_1 - m_2) + (m_3 - m_4) + \dots + (m_{n-1} - m_n)$$

Quantity of refrigerant to be perfused during running  $m' = M - m$

$M$  is the required total quantity

If the pre-perfusion quantity ( $m$ ) reaches the required total quantity for the system, turn off the valve of the refrigerant tank immediately to finish perfusing and proceed with step 11.

Step 11: Remove the pressure gauge.

## 9.2.2 Refrigerant Perfusion During Running

Step 1: Turn off the valve of the refrigerant tank and reconnect the pressure gauge pipe. Disconnect the low pressure gauge pipe from the detection valve opening of the gas liquid and connect it to the low pressure detection valve, as shown in the following figure.

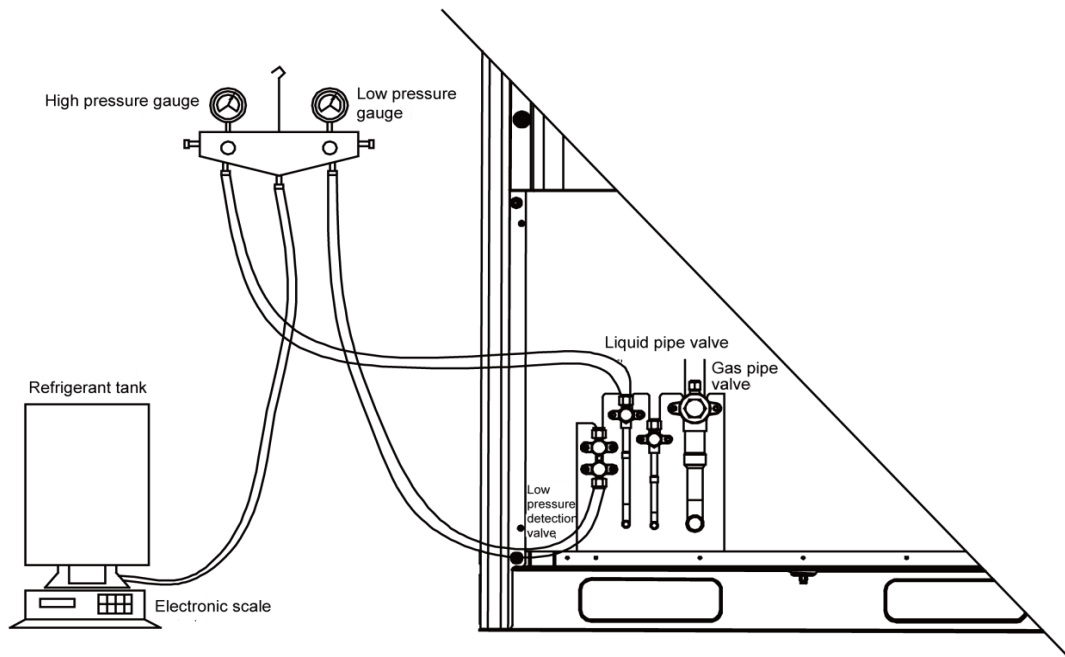

Step 2: Turn on the valves for the liquid and gas pipes of each module completely. For the modular unit, the oil-equalizing valve of each module also needs to be turned on.

Step 3: Make the system to run in commissioning mode via the commissioning software or the main board of the ODU. (For details, see the description on commissioning.)

Step 4: When the commissioning step goes to refrigerant perfusion, turn on the valve of the refrigerant tank and perfuse the remaining quantity (m<sup>3</sup>).

Step 5: After all refrigerant is perfused, turn off valve of the refrigerant tank and wait till commissioning is automatically is completed for the system.

Step 6: Remove the pressure gauge to finish refrigerant perfusion.

### ▲ CAUTION

- Because R410A is a mixture of refrigerant, therefore, it must be charged in a liquid form. Otherwise, unit will not work stably and effectively.

- Do not expose the R410A refrigerant tank to direct sunlight. Otherwise, the internal pressure may get too high and cause explosion.

- Pipeline for the R410A refrigerating system must have relevant valid certificates.
- During welding, avoid overheating the pipeline.
- System must not filled with refrigerant other than R410A.

### ▲ WARNING

- Pipe to be vacuumed : gas pipe, water pipe, common pipe
- If the refrigerant amount is not exact, it may not operate properly.
- If additionally bottled refrigerant amount is over  $\pm 10\%$ , condenser burning or insufficient indoor unit performance may be caused.



# CHAPTER 3 COMMISSIONING OPERATION

## 1 SECURITY REQUIREMENTS

### 1.1 PRECAUTIONS FOR CONSTRUCTION

#### ▲WARNING

- All commissioning and maintenance personnel must learn and strictly comply with construction security specifications. Security measures must be taken especially for outdoor operations.
- Workers of special types of labor, such as refrigerating engineers, electricians, and welders, must have professional certificates. No worker is allowed to do another type of labor.
- The equipment must be powered off before relevant operations, and other security requirements should be strictly complied with.
- All installation and maintenance operations must comply with design requirements of this product and national and local security operation requirements. Rule-breaking operations are prohibited.

### 1.2 PRECAUTIONS FOR THE USE OF REFRIGERANTS

The GMV5 serial unit is a refrigerating system of R410A working substances. Pay attention to the following points:

#### ▲WARNING

- The refrigerating system of R410A working substances has a higher working pressure than that of R22 working substances. The working pressure of the former is 1.6 times than that of the latter.
- The refrigerating system of R410A working substances uses thicker-walled copper tubes than that of R22 working substances. Adopt copper tubes with appropriate wall thickness.
- R410A working substances are azeotropic mixture working substances. Refrigerants must be appended in the form of liquid.

### 1.3 FUNCTION SETTINGS OF ODU

Function application of ODUs consists of function DIP switch settings and function button settings, including special engineering requirements.

#### 1.3.1 System Function DIP Switch Settings

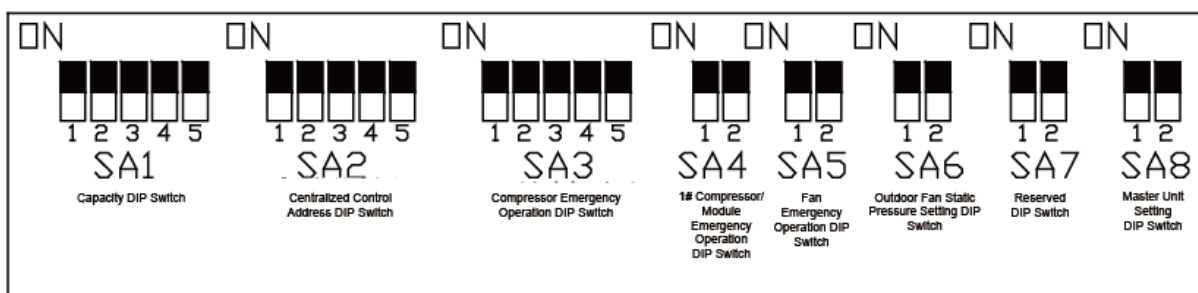

DIP Switch	Name	Meaning	Factory Settings	Remark
SA1_capacity	Capacity DIP switch	Defines the rated capacity of the unit.	Defined based on the model.	The factory settings cannot be changed.
SA2_A ddr-CC	Centralized control address DIP switch	Defines and differentiates addresses of different systems in the case of centralized control by multiple systems.	00000	The address DIP switch is used only when centralized control is required. Otherwise, the factory settings are used without being changed. The address DIP switch is valid only when it is set on the master unit.
SA3_C OMP-E	2#-6# compressor emergency operation DIP switch	Provides aftersales emergency settings for 2#-6# compressors.	00000	It is better not to use the emergency function. Replace the compressor at the first time when an exception occurs.
SA4_I/M-E	1# compressor/module emergency operation DIP switch	Provides aftersales emergency settings for 1# compressor/module.	00	It is better not to use the emergency function. Replace the compressor at the first time when an exception occurs.
SA5_F AN-E	Fan emergency operation DIP switch	Provides aftersales emergency settings for fans.	00	It is better not to use the emergency function. Replace relevant parts of the fan at the first time when an exception occurs.
SA6_E SP_S	Outdoor fan static pressure setting DIP switch	Sets the static pressure of the fan according to the static pressure of the exhaust pipeline connected with the engineering unit, to guarantee normal operation of the unit.	00	This DIP switch should be set based on actual engineering conditions, neither over-large nor over-small. It is unnecessary to change the factory settings in outdoor scenarios.
SA7	Reserved DIP switch	—	00	—
SA8_M ASTER-S	Master unit setting DIP switch	Defines the master unit.	00	A master unit must be set, and only one master unit can be set in each refrigerating system. This DIP switch is mandatory. The default factory setting is the master unit status.

### **▲ CAUTION**

- On the master module, the SA8 DIP switch must be set again, the SA1 DIP switch cannot be further set, and other DIP switches retain the factory settings without special requirements.
- Function DIP switches must be set when the ODU is powered off, and then the settings are valid after the ODU is powered on.

### **▲ CAUTION**

- If above DIP switch setting is incorrect, unit will work abnormally and compressor may even be damaged.

Meanings and setting methods of function DIP switches are as follows:

### 1.3.1.1 Unit Capacity DIP Switch (SA1\_capacity)

The unit capacity DIP switch (SA1\_capacity) has been set upon factory departure. It is unnecessary to further set the DIP switch. In addition, users are not allowed to change the DIP switch settings. Otherwise, the system may work abnormally or even the compressor may be damaged.

### 1.3.1.2 Centralized Control Address DIP Switch (SA2\_Addr-CC)

The centralized control address DIP switch (SA2\_Addr-CC) indicates the centralized control address required when different refrigerating systems are controlled in a centralized manner. The default factory setting is "00000".

If it is not required to use centralized control between multiple refrigerating systems, this DIP switch can retain the factory settings without being changed.

If it is required to use centralized control between multiple refrigerating systems, set the DIP switch according to the following methods:

- 1) The DIP switch must be set on the master unit. Otherwise, the setting is invalid.
- 2) On the same refrigerating system, the centralized control address DIP switch (SA2\_Addr-CC) on a non-master unit is invalid, and it is unnecessary to change the settings.
- 3) The centralized control address DIP switch (SA2\_Addr-CC) on the master unit of a refrigerating system must be set to "0000×", and this system is the master system.
- 4) The centralized control address DIP switch (SA2\_Addr-CC) on the master unit of other refrigerating systems must be set as follows:

SA2					Address No.
DIP1	DIP2	DIP3	DIP4	DIP5	
1	0	0	0	×	2
0	1	0	0	×	3
1	1	0	0	×	4
0	0	1	0	×	5
1	0	1	0	×	6
0	1	1	0	×	7
1	1	1	0	×	8
0	0	0	1	×	9
1	0	0	1	×	10
0	1	0	1	×	11
1	1	0	1	×	12
0	0	1	1	×	13
1	0	1	1	×	14
0	1	1	1	×	15
1	1	1	1	×	16

On the DIP switch, "ON" indicates "0" status and the opposite direction indicates "1" status. "×" indicates invalid status.

- 5) The centralized control address DIP switch (SA2\_Addr-CC) cannot be the same between different refrigerating systems. Otherwise, address conflicts may occur and the unit cannot run properly.

6) Suppose the centralized control address (SA2-Addr-CC) of the master unit for one GMV system is set to “1 1 1 1 X”, this system is the master mode system and its running mode will take the priority. That is, the running mode of the indoor units of other systems cannot conflict with that of this master mode system. For instance, when the running mode of the master mode system is set to cooling, it for the indoor units of other systems cannot be set to heating.

1.3.1.3 Compressor Emergency Operation DIP Switch (SA3\_COMP-E)

Corresponding to 2#-6# compressors, the compressor emergency operation DIP switch (SA3\_COMP-E) is used for aftersales emergency settings when an exception occurs on a compressor. It can shield the operation of the abnormal compressor in a short time and guarantee the emergency operation of other compressors.

When it is required to shield the operation of 2#-6# compressors upon failure, set the DIP switch according to the following methods:

Compressor Emergency Operation DIP Switch (SA3_COMP-E)					Remark
DIP1	DIP2	DIP3	DIP4	DIP5	
0	0	0	0	0	Not shielding the operation of 2#-6# compressors
1	0	0	0	0	Shielding the operation of 2# compressor
0	1	0	0	0	Shielding the operation of 3# compressor
0	0	1	0	0	Shielding the operation of 4# compressor
0	0	0	1	0	Shielding the operation of 5# compressor
0	0	0	0	1	Shielding the operation of 6# compressor

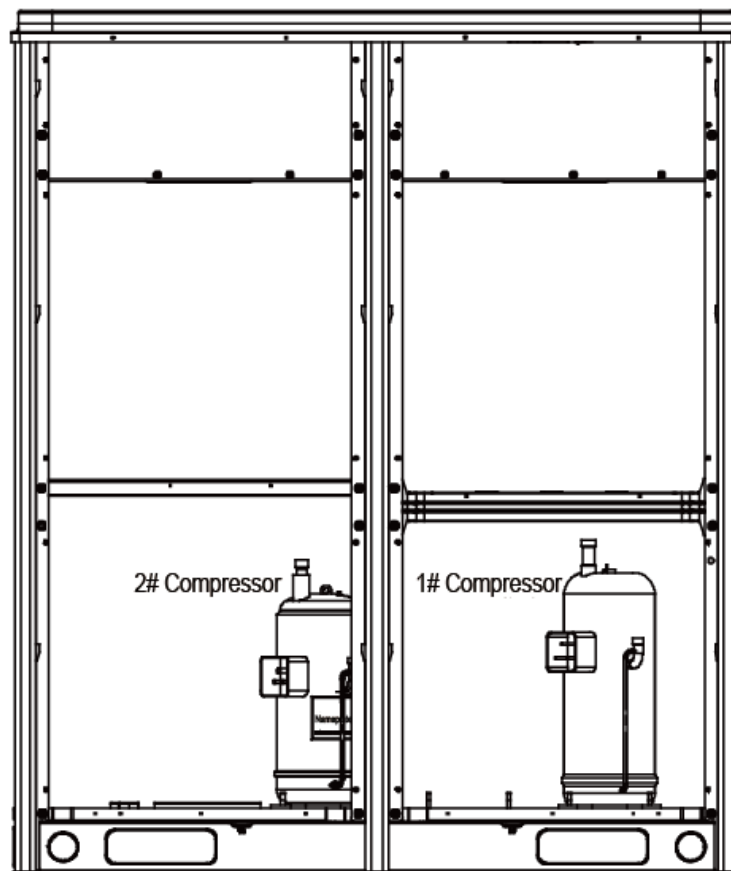

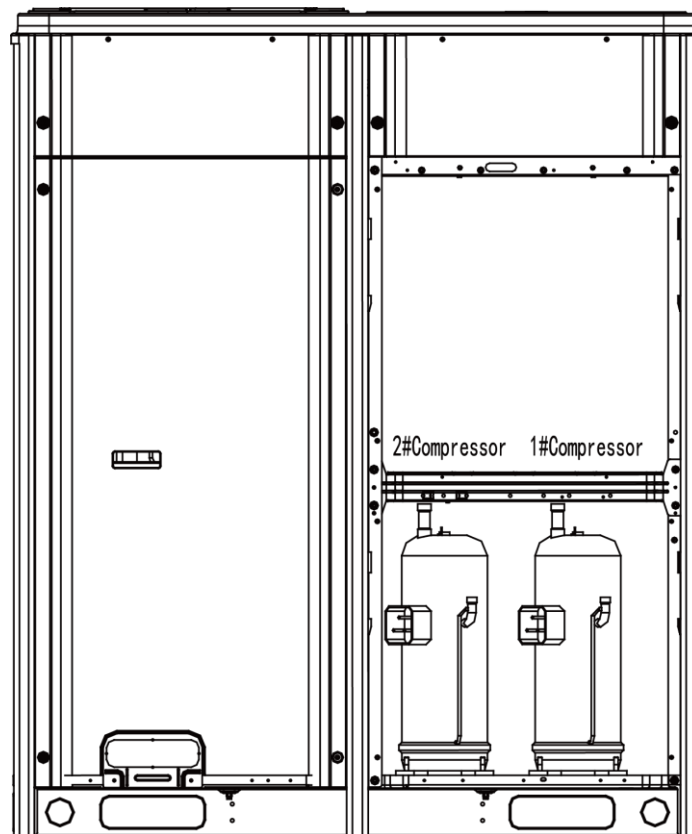

**Precautions:**

- ① When the DIP switch setting is not covered in the above scope, a DIP switch setting exception fault may occur.
- ② Only one compressor can be set to emergency mode on a module.
- ③ The compressor emergency operation mode is valid only in a single-module multi-compressor system.
- ④ The default factory setting is “00000”.
- ⑤ The system cannot continually run for more than 24 hours in compressor emergency operation status. Once 24 hours are exceeded, the entire unit will be forcibly stopped and the limited operation code “Ad” is displayed on the IDU.
- ⑥ 1#-6# compressors are defined from right to left facing the front of the unit.

**1.3.1.4 1# Compressor/Module Emergency Operation DIP Switch (SA4\_I/M-E)**

The 1# compressor/module emergency operation DIP switch (SA4\_I/M-E) is used for aftersales emergency settings when an exception occurs on the 1# compressor/module. It can shield the operation of the abnormal compressor/module in a short time and guarantee the emergency operation of other compressors.

When it is required to set the 1# compressor/module to emergency mode, set the DIP switch as follows:

1# Compressor/Module Emergency Operation DIP Switch (SA4_I/M-E)		
DIP1	DIP2	Remark
0	0	Not shielding the operation of 1# compressor/module
1	0	Shielding the operation of 1# compressor
0	1	Shielding the operation of the module

**Precautions:**

- ① When the DIP switch setting is not covered in the above scope, a DIP switch setting exception fault may occur.
- ② Only one compressor can be set to emergency mode on a module.
- ③ The compressor emergency operation mode is valid only in a single-module multi-compressor system.
- ④ The module emergency operation mode is valid only in a system with more than two modules connected in parallel.
- ⑤ Only one module can be set to emergency operation mode in each system.
- ⑥ The default factory setting is "00".
- ⑦ The system cannot continually run for more than 24 hours in compressor emergency operation status. Once 24 hours are exceeded, the entire unit will be forcibly stopped and the limited operation code "Ad" is displayed on the IDU.
- ⑧ The system cannot continually run for more than 48 hours in module emergency operation status. Once 48 hours are exceeded, the entire unit will be forcibly stopped and the limited operation code "Ad" is displayed on the IDU.
- ⑨ 1#-6# compressors are defined from right to left facing the front of the unit.

**1.3.1.5 Fan Emergency Operation DIP Switch (SA5\_FAN-E)**

The fan emergency operation DIP switch (SA5\_FAN-E) is used for aftersales emergency settings when an exception occurs on a dual-module fan. It can shield the operation of a fan in a short time and guarantee the emergency operation of the system.

(1) Fan positions

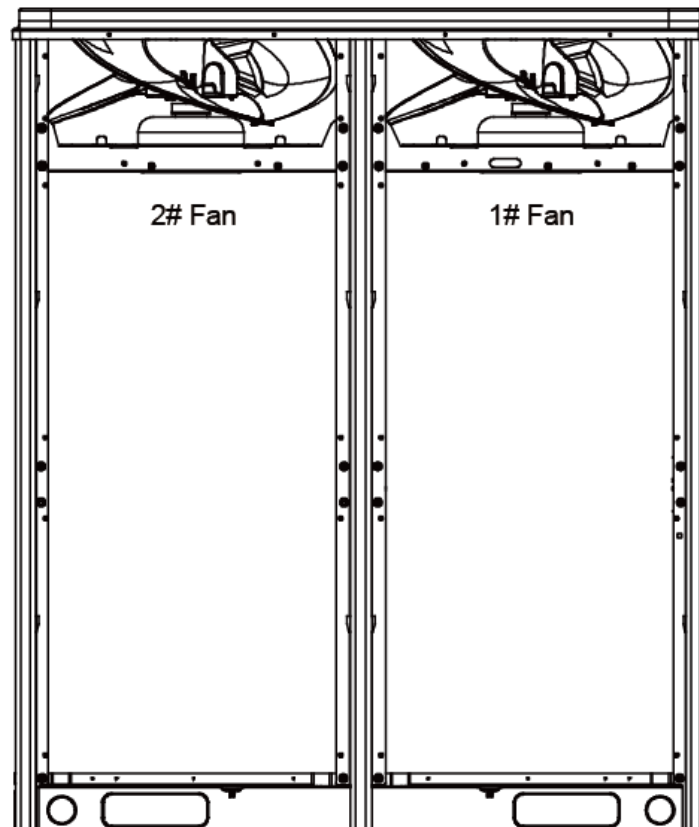

(2) When it is required to set the fan to emergency mode, set the DIP switch as follows:

Fan Emergency Operation DIP Switch (SA5_FAN-E)		
DIP1	DIP2	Remark
0	0	No fan in emergency operation mode
1	0	Shielding the operation of 1# fan
0	1	Shielding the operation of 2# fan

#### Precautions:

- ① When the DIP switch setting is not covered in the above scope, a DIP switch setting exception fault may occur.
- ② Only one fan can be set to emergency mode on a module.
- ③ The default factory setting is “00”.
- ④ The system cannot continually run for more than 120 hours in fan emergency operation status. Once 120 hours are exceeded, the entire unit will be forcibly stopped and the limited operation code “Ad” is displayed on the IDU.

#### 1.3.1.6 Outdoor Fan Static Pressure Setting DIP Switch (SA6\_ESP\_S)

The outdoor fan static pressure setting DIP switch (SA6\_ESP\_S) is used in special scenarios such as the unit installation equipment room. In scenarios where air ducts are required to be connected, zero static pressure (0 Pa), low static pressure (30 Pa), medium static pressure (50 Pa), and high static pressure (82 Pa) can be set according to the design of air ducts. The setting methods are as follows:

Outdoor Fan Static Pressure Setting DIP Switch (SA6_ESP_S)		
DIP1	DIP2	Static Pressure Range
0	0	0 Pa/0in.W.G.
1	0	30 Pa/0.12in.W.G.
0	1	50 Pa/0.2in.W.G.
1	1	82 Pa/0.328in.W.G.

The default factory setting is “00”.

Note that the DIP switch should be independently set on each module.

#### 1.3.1.7 Reserved Function DIP Switch (SA7)

SA7 is the reserved function DIP switch and meaningless currently.

#### 1.3.1.8 Master Unit Setting DIP Switch (SA8\_MASTER-S)

The master unit setting DIP switch (SA8\_MASTER-S) defines module management of a system. A master unit must be set, and only one master unit can be set in each refrigerating system (in power-off status). The setting methods are as follows:

Master Unit Setting DIP Switch (SA8_MASTER-S)		
DIP1	DIP2	Remark
0	0	Master unit
1	0	Sub-module

Upon factory departure, all modules are in “00” master unit status by default. When multiple modules are connected in parallel, only one module retains the master unit status and other modules are set to sub-module status. When a module is independently used, it uses the factory settings.

For the basic module set to master unit, the module address is displayed as “01” on the main board.

**Precautions:**

- ① When the DIP switch setting is not covered in the above scope, a DIP switch setting exception fault may occur.
- ② A module must be set to master unit status, and only one module can be set to master unit status in each refrigerating system. Other modules are set to sub-module status.
- ③ Settings must be performed in power-off status.
- ④ The default factory setting is "00" master unit status.



- Master module must be set correctly; otherwise units cannot be started up.

**1.3.1.9 DIP Switch Example**

(1) Explanation of DIP switch positions

On the DIP switch, "ON" indicates "0" status and the opposite direction indicates "1" status.

The position of white lever indicates the position to be set to.



(2) Example

The following takes master unit settings as an example. Assume that a system consists of three modules: module a, module b, and module c. Set module c to master unit and the other two modules to sub-modules. The settings are as follows:

**1.3.2 System Function Button Operations**

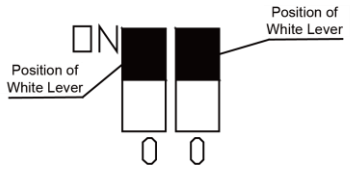
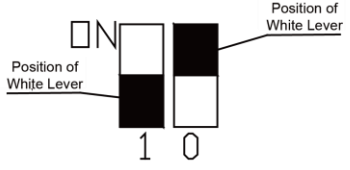
Module c (Master Module)	 <p>SAB_MASTER-S</p>
Module a/Module b (Sub-module)	 <p>SAB_MASTER-S</p>

**Note:**

- ① System function settings and query must be performed after commissioning of the entire unit.
- ② System function settings and query can be used no matter whether the entire unit runs.



### 1.3.2.1 Introduction to Function Buttons

## ▲WARNING

• When function buttons are used to set functions for outdoor unit, the cover of electric box and panel must be assembled well. Setting can only be done through the maintenance window. Otherwise, electric shock may occur.

The main board AP1 of the ODU consists of eight function buttons:

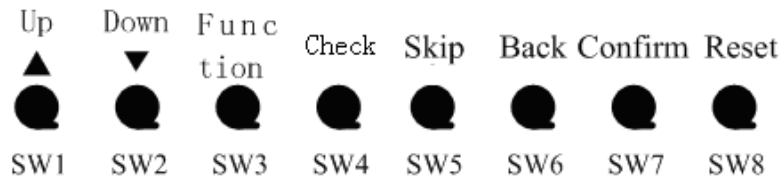

Function Button Name and Meaning		
Button	Code	Function Meaning
SW1	UP	Indicates the upward selection button.
SW2	DOWN	Indicates the downward selection button.
SW3	FUNCTION	Indicates the function button, used for function settings.
SW4	CHECK	Indicates the query button, used for function query.
SW5	SKIP	Indicates the skip button.
SW6	BACK	Indicates the return button, used to return to the upper-level menu.
SW7	CONFIRM	Indicates the confirmation button.
SW8	RESET	Indicates the reset button, used to restore factory settings.

### 1.3.2.2 Introduction to Functions

#### (1) List of functions

Function Code	Function Name	Function Meaning	Factory Settings		Remark
			Code	Meaning	
A2	Refrigerant recovery operation	Fully or partially recovers refrigerants in a faulty module or IDU pipeline according to the system pressure after automatic startup during maintenance.	—	—	It can only be set.
A6	Unit cooling/heating function	Sets the unit to cooling/heating, single-cooling, single-heating, or air supply mode for centralized management.	nA	Cooling/Heating function	It can be set and queried.
A7	Outdoor silent mode	Sets different silent modes to meet users' noise requirements.	00	No silent settings	It can be set and queried.
A8	Aftersales vacuuming mode	Automatically enables all electronic expansion valves and electromagnetic valves during maintenance to guarantee vacuum processing in all pipelines.	—	—	It can only be set.
n0	Conservation control 1	Automatically decreases the power consumption of the unit according to system operation parameters.	01	No automatic conservation settings	It can be set and queried.
n3	Forcible defrosting operation	Forcibly enables ODU defrosting operation.	—	—	It can only be set.
n4	Conservation control 2	Forcibly decreases the maximum power consumption of the unit.	00	No capacity output limitation settings	It can be set and queried.

Function Code	Function Name	Function Meaning	Factory Settings		Remark
			Code	Meaning	
n5	Indoor unit project number offset	Prevents IDU project number conflicts when different refrigerating systems are controlled in a centralized manner.	—	—	It can only be set.
n6	Fault query	Queries historical fault information of the ODU.	—	—	It can only be queried.
n7	Parameter query	Queries real-time operation parameters of the ODU.	—	—	It can only be queried.
n8	Indoor unit project number query	Displays project numbers of all IDUs through ODU operations.	—	—	It can only be queried.
n9	Online IDU quantity query	Displays the number of online IDUs.	—	—	It can only be queried.
nb	Outdoor unit bar code function query	Queries the entire-unit bar code and controller bar code of ODU.	—	—	It can only be queried.

## ▲ CAUTION

- If above function settings are incorrect, unit will run abnormal and compressor may even be damaged.

### (2) Description of Functions

#### 1) A2 Refrigerant recovery operation

This function partially recovers refrigerants in a faulty module or IDU pipeline during unit maintenance. The refrigerant recovery volume of each basic module is as follows:

Model of Basic Module		Maximum Refrigerant Recovery Volume
GMV-72WM/B-F(U)	GMV-72WM/B-U(U)	7.5kg/16.53LBS
GMV-96WM/B-F(U)	GMV-96WM/B-U(U)	13.5kg/29.76LBS
GMV-120WM/B-F(U)	GMV-120WM/B-U(U)	13.5kg/29.76LBS
GMV-144WM/B1-F(U)	/	13.5kg/29.76LBS
GMV-168WM/B1-F(U)	/	18.4kg/40.56LBS

This function falls into two modes: faulty module refrigerant recovery and IDU pipeline refrigerant recovery.

Refrigerant Recovery Mode Code	Refrigerant Recovery Mode Name	Remark
01	Indoor unit pipeline refrigerant recovery	This mode is selected when an IDU fails and it is required to recover refrigerants from the IDU pipeline to the out door units.
02	Basic module refrigerant recovery	This mode is selected when a basic module fails and it is required to recover refrigerants from this basic module to the other out door units and pipeline..

When this function is enabled, the ODU automatically starts and recovers refrigerants to the ODU or IDU pipeline.

## 2) A6 Unit cooling/heating function

This function sets operation modes of the entire unit, including:

Function Mode of ODU		Operation Mode of IDU
Code	Name	
nA	Cooling/Heating	Cooling mode, dehumidifying mode, heating mode, and air supply mode. (Note: The heating mode cannot work with other modes at the same time.) (factory settings)
nC	Single-cooling	Cooling mode, dehumidifying mode, and air supply mode.
nH	Single-heating	Heating mode and air supply mode. (Note: The heating mode cannot work with the air supply mode at the same time.)
nF	Air supply	Air supply mode.

The user or administrator can set operation modes of the ODU based on actual situations to prevent conflicts.

When it is required to set different refrigerating systems to the same function mode, set the master system according to the above requirements. For the master system settings, see the "Centralized Control Address DIP Switch (SA2\_Addr-CC)" section.

## 3) A7 Outdoor silent mode

This function is used when users require lower environment noises, including nighttime automatic silent mode and forcible silent mode.

For the nighttime automatic silent mode, the system automatically judges the highest daytime environment temperature and then starts silent operations in a certain interval to guarantee nighttime low-noise operations. The nighttime automatic silent mode falls into nine categories:

Silent Mode	Code	Starting the Silent Mode X Hours after the Daytime Temperature Reaches the Highest	Stopping the Nighttime Silent Mode after Continual Operations for Y Hours	Noise Degree
Mode 1	01	6	10	Low-noise mode
Mode 2	02	6	12	
Mode 3	03	8	8	
Mode 4	04	8	10	
Mode 5	05	10	8	
Mode 6	06	10	10	
Mode 7	07	4	14	
Mode 8	08	6	8	Low- and medium-noise mode
Mode 9	09	12	10	superlow-noise mode

**NOTE:** The highest daytime temperature is generally in 13:00-15:00.

Recommendation: Model 1.

For the forcible silent mode, the system runs in low-noise mode no matter in the daytime or nighttime. The forcible silent mode falls in three categories:

Silent Mode	Code	Noise Degree
Mode 10	10	Low-noise mode
Mode 11	11	Low- and medium-noise mode
Mode 12	12	superlow-noise mode

**NOTE:** The factory setting is "00".

## ▲ CAUTION

- After silent mode is set, unit's cooling and heating capacity will be lowered correspondingly. Please be noted.

### 4) A8 Aftersales vacuuming mode

This function ensures the vacuum degree of the entire system during maintenance to prevent operation functions of dead zones. Expansion valves and electromagnetic valves of the unit will be enabled after this function is set.

### 5) Conservation control 1

System conservation is set when conservation operations are required. The default factory setting is capacity priority control mode. The system capacity may fall off after the conservation mode is set.

Code	Function Name
01	Conservation control – invalid (factory settings)
02	Conservation control - valid

### 6) Forcible defrosting operation

This function is set when forcible defrosting is required for the unit during maintenance. After this function is enabled, the system automatically quits based on quitting conditions and then automatically runs based on system conditions.

### 7) Conservation control 2

The highest capacity output limitation is set when users require forcibly limiting the system power consumption. The setting scope is as follows:

Code	Highest Output Capacity
10	100% (factory settings)
09	90%
08	80%

**Note:** The cooling or heating effect may fall off after the capacity limitation is set.

### 8) Indoor unit project number offset

This function sets the IDU project number when multiple refrigerating systems are controlled in a centralized manner (by using a remote monitor or centralized controller), avoiding the same project number between different systems. If the project number is not set, project number conflicts may occur between systems.

This function only needs to be set on the master system, which is the system with the centralized control address SA2 DIP switch being "0000X". For details, see the "Centralized Control Address DIP Switch (SA2\_Addr-CC)" section.

### 9) Fault query

This function queries historical faults of the system. Up to five historical faults can be memorized in time order.

### 10) Parameter query

This function queries operation parameters of each module of the ODU in real time.

### 11) Indoor unit address query

This function queries addresses of all IDUs through one operation of the ODU.

12) n9 Online IDU quantity query

This function queries the number of online IDUs through the ODU.

### 1.3.3 Function Setting Operations

Step 1: Open the commissioning window of the master unit panel.

Step 2: Power on the entire unit.

Step 3: Press "SW3" on the master unit to enter the to-be-selected status of function settings. By default, the master unit is displayed as follows:

LED1		LED2		LED3	
Function Code	Display Mode	Current Progress	Display Mode	Current Status	Display Mode
A7	Blinking	00	Blinking	00	Blinking

Users can select corresponding functions by pressing "SW1 (UP)" or "SW2 (DOWN)" on the master unit, including:

LED1		LED2		LED3	
Function Code	Display Mode	Current Progress	Display Mode	Current Status	Display Mode
A7	Blinking	00	Blinking	00	Blinking
A6	Blinking	00	Blinking	00	Blinking
A2	Blinking	00	Blinking	00	Blinking
A8	Blinking	00	Blinking	00	Blinking
n0	Blinking	01	Blinking	00	Blinking
n3	Blinking	00	Blinking	00	Blinking
n4	Blinking	00	Blinking	00	Blinking
n5	Blinking	00	Blinking	00	Blinking

After selecting the functions to be set, press "SW7" to confirm entering function settings. The master unit is displayed as follows:

LED1		LED2		LED3	
Function Code	Display Mode	Current Progress	Display Mode	Current Status	Display Mode
A7	On	00	Blinking	OC	Blinking
A6	On	nC	Blinking	nC	Blinking
A2	On	01	Blinking	00	Blinking
A8	On	00	Blinking	OC	Blinking
n0	On	01	Blinking	OC	Blinking
n3	On	00	Blinking	00	Blinking
n4	On	10	Blinking	OC	Blinking
n5	On	00	Blinking	OC	Blinking

Then go to step 4 to set corresponding functions.

Step 4: Set function parameters.

Setting methods of function parameters are as follows:

(1) A7 Outdoor silent mode settings

Step 1: Confirm entering the A7 outdoor silent mode settings. The master unit is displayed as follows:

LED1		LED2		LED3	
Function Code	Display Mode	Silent Mode Code	Display Mode	Current Status	Display Mode
A7	On	00	Blinking	OC	Blinking

Step 2: Select a corresponding silent mode by pressing "SW1 (UP)" or "SW2 (DOWN)".

LED1		LED2		LED3	
Function Code	Display Mode	Silent Mode Code	Display Mode	Current Status	Display Mode
A7	On	00	Blinking	OC	Blinking
A7	On	01	Blinking	OC	Blinking
A7	On	02	Blinking	OC	Blinking
A7	On	03	Blinking	OC	Blinking
A7	On	04	Blinking	OC	Blinking
A7	On	05	Blinking	OC	Blinking
A7	On	06	Blinking	OC	Blinking
A7	On	07	Blinking	OC	Blinking
A7	On	08	Blinking	OC	Blinking
A7	On	09	Blinking	OC	Blinking
A7	On	10	Blinking	OC	Blinking
A7	On	11	Blinking	OC	Blinking
A7	On	12	Blinking	OC	Blinking

Step 3: Press "SW7" to confirm selecting the mode. The master unit is displayed as follows:

LED1		LED2		LED3	
Function Code	Display Mode	Silent Mode Code	Display Mode	Current Status	Display Mode
A7	On	00	On	OC	On
A7	On	01	On	OC	On
A7	On	02	On	OC	On
A7	On	03	On	OC	On
A7	On	04	On	OC	On
A7	On	05	On	OC	On
A7	On	06	On	OC	On
A7	On	07	On	OC	On
A7	On	08	On	OC	On
A7	On	09	On	OC	On
A7	On	10	On	OC	On
A7	On	11	On	OC	On
A7	On	12	On	OC	On

On the master unit, press "SW6" to return to the upper level (press "SW6" in setting status to return to the upper level; press "SW6" after settings are completed to restore the normal operating status of the unit).

If no button operations are performed on the master unit for five minutes, the function setting automatically quits and the unit restores the current status.

The default factory setting is "00", that is, no silent mode.

#### (2) A6 Unit cooling/heating function settings

Step 1: Confirm entering the A6 unit cooling/heating function settings. The master unit is displayed as follows:

LED1		LED2		LED3	
Function Code	Display Mode	ODU Function Mode Code	Display Mode	ODU Function Mode Code	Display Mode
A6	On	nC	Blinking	nC	Blinking

Step 2: Select a corresponding cooling/heating function by pressing "SW1 (UP)" or "SW2 (DOWN)".

LED1		LED2		LED3	
Function Code	Display Mode	ODU Function Mode Code	Display Mode	ODU Function Mode Code	Display Mode
A6	On	nC	Blinking	nC	Blinking
A6	On	nH	Blinking	nH	Blinking
A6	On	nA	Blinking	nA	Blinking
A6	On	nF	Blinking	nF	Blinking

Step 3: Press "SW7" to confirm selecting the mode. The master unit is displayed as follows:

LED1		LED2		LED3	
Function Code	Display Mode	ODU Function Mode Code	Display Mode	ODU Function Mode Code	Display Mode
A6	On	nC	On	nC	On
A6	On	nH	On	nH	On
A6	On	nA	On	nA	On
A6	On	nF	On	nF	On

On the master unit, press "SW6" to return to the upper level (press "SW6" in setting status to return to the upper level; press "SW6" after settings are completed to restore the normal operating status of the unit).

If no button operations are performed on the master unit for five minutes, the function setting automatically quits and the unit restores the current status.

The default factory setting is "nA" cooling/heating.

### (3) A2 Refrigerant recovery operation settings

Step 1: Confirm entering the A2 refrigerant recovery operation settings. The master unit is displayed as follows:

LED1		LED2		LED3	
Function Code	Display Mode	Refrigerant Recovery Code	Display Mode	Current Status	Display Mode
A2	On	01	Blinking	00	Blinking

Step 2: The default setting is "01". Select "01" or "02" by pressing "SW1 (UP)" or "SW2 (DOWN)". Press "SW7" to confirm selecting the mode.

On the master unit, press "SW6" to return to the upper level.

If no button operations are performed on the master unit for five minutes, the function setting automatically quits and the unit restores the current status.

### ✧ Indoor unit pipeline refrigerant recovery

Step 3: Select "01" as in step 2 to enter IDU refrigerant recovery. Digital LEDs and status LEDs of all basic modules are displayed as follows:

LED1		LED2		LED3	
Function Code	Display Mode	Refrigerant Recovery Code	Display Mode	Current Status	Display Mode
A2	On	01	On	[Module low-pressure Ps]	On

LED3 shows the low-pressure value of a module. If the value is negative, LED3 circularly displays the negative code "nE" and the numeric value every one second. For example, for -30°C, LED3 alternately displays "nE" for one second and then "30" for another second.

Step 4: Close liquid-tube stop valves of all basic modules of the ODU. When the low-pressure value displayed on LED3 continually blinks, quickly close air-tube stop valves of all basic modules and then press "SW7" on the master unit to confirm completing refrigerant recovery or power off the entire unit.

If no operations are performed after the low-pressure value displayed on LED3 continually blinks for three minutes, the entire unit will be forcibly stopped.

On the master unit, press "SW6" to return to the upper level for restoring the standby status of the entire unit (press "SW6" in setting status to return to the upper level; press "SW6" after settings are completed to restore the normal operating status of the unit).

**NOTICE!** Another startup is not allowed within 10 minutes after refrigerant recovery.

✧ **Basic module refrigerant recovery**

Step 3: Set the basic module requiring refrigerant recovery to module emergency operation status and close the liquid-tube stop valve of the emergency status module. Select "02" as in step 2 to enter basic module refrigerant recovery. The display is as follows:

LED1		LED2		LED3	
Function Code	Display Mode	Current Progress	Display Mode	Current Status	Display Mode
A2	On	02	On	Module high-pressure	On

LED3 shows the high-pressure value of the module.

Step 4: When the high-pressure value displayed on LED3 continually blinks (displayed as 0°C if the high pressure is less than 0°C), quickly close the air-tube stop valve of the emergency module and then press "SW7" on the master unit to confirm completing refrigerant recovery or power off the entire unit.

If no operations are performed after the high-pressure value displayed on LED3 continually blinks for three minutes, the entire unit will be forcibly stopped.

On the master unit, press "SW6" to return to the upper level for restoring the standby status of the entire unit (press "SW6" in setting status to return to the upper level; press "SW6" after settings are completed to restore the normal operating status of the unit).

**NOTICE!**

Before the basic module refrigerant recovery operation, users must close the liquid-tube stop valve of the basic module requiring refrigerant recovery.

Another startup is not allowed within 10 minutes after refrigerant recovery.

(4) A8 Aftersales vacuuming mode settings

Step 1: Confirm entering the A8 aftersales vacuuming mode settings. The master unit is displayed as follows:

LED1		LED2		LED3	
Function Code	Display Mode	Current Progress	Display Mode	Current Status	Display Mode
A8	On	00	Blinking	OC	Blinking

Enter the to-be-confirmed status of system vacuuming mode settings.



Step 2: Press "SW7" to confirm entering the to-be-confirmed status of system vacuuming mode settings. All modules are displayed as follows:

LED1		LED2		LED3	
Function Code	Display Mode	Current Progress	Display Mode	Current Status	Display Mode
A8	On	00	On	OC	On

Expansion valves and electromagnetic valves of all outdoor and IDUs are opened, and the entire unit cannot be enabled.

Press "SW6" on the master unit to quit the vacuuming status. Alternatively, the entire unit quits the vacuuming status after 24 hours.

#### (5) n0 System conservation operation settings

Step 1: Confirm entering the n0 system conservation operation settings. The master unit is displayed as follows:

LED1		LED2		LED3	
Function Code	Display Mode	Code	Display Mode	Current Status	Display Mode
n0	On	01	Blinking	OC	Blinking

Step 2: Select a corresponding mode by pressing "SW1 (UP)" or "SW2 (DOWN)".

LED1		LED2		LED3	
Function Code	Display Mode	Code	Display Mode	Current Status	Display Mode
n0	On	01	Blinking	OC	Blinking
n0	On	02	Blinking	OC	Blinking

Step 3: Press "SW7" to confirm selecting the mode. The master unit is displayed as follows:

LED1		LED2		LED3	
Function Code	Display Mode	Code	Display Mode	Current Status	Display Mode
n0	On	01	On	OC	On
n0	On	02	On	OC	On

If no button operations are performed for five minutes, the function setting automatically quits and the unit restores the current status. (Press "SW6" in setting status to return to the upper level; press "SW6" after settings are completed to restore the normal operating status of the unit.)

#### (6) n3 Forcible defrosting operation settings

Step 1: Confirm entering the n3 forcible defrosting operation settings. The master unit is displayed as follows:

LED1		LED2		LED3	
Function Code	Display Mode	Current Progress/Mode	Display Mode	Current Status	Display Mode
n3	On	00	Blinking	00	Blinking

Step 2: Press "SW7" to confirm entering forcible defrosting. The master module is displayed as follows:

LED1		LED2		LED3	
Function Code	Display Mode	Current Progress/Mode	Display Mode	Current Status	Display Mode
n3	On	00	On	00	On

When the unit reaches defrosting quit conditions, the system automatically quits and restores the normal operation control.

#### (7) n4 Highest capacity output limitation settings

Step 1: Confirm entering the n4 highest capacity output limitation settings. The master unit is displayed as follows:

LED1		LED2		LED3	
Function Code	Display Mode	Highest Output Capacity	Display Mode	Current Status	Display Mode
n4	On	10	Blinking	OC	Blinking

Step 2: Select a corresponding capacity limitation value by pressing "SW1 (UP)" or "SW2 (DOWN)".

LED1		LED2		LED3	
Function Code	Display Mode	Highest Output Capacity	Display Mode	Current Status	Display Mode
n4	On	10	Blinking	OC	Blinking
n4	On	09	Blinking	OC	Blinking
n4	On	08	Blinking	OC	Blinking

Step 3: Press "SW7" to confirm selecting the mode. The master module is displayed as follows:

LED1		LED2		LED3	
Function Code	Display Mode	Highest Output Capacity	Display Mode	Current Status	Display Mode
n4	On	10	On	OC	On
n4	On	09	On	OC	On
n4	On	08	On	OC	On

If no button operations are performed on the master unit for five minutes, the function setting automatically quits and the unit restores the current status. (Press "SW6" in setting status to return to the upper level; press "SW6" after settings are completed to restore the normal operating status of the unit.)

(8) n5 Indoor unit project number offset settings

Step 1: Confirm entering the n5 IDU project number offset settings. The master unit is displayed as follows:

LED1		LED2		LED3	
Function Code	Display Mode	Current Progress/Mode	Display Mode	Current Status	Display Mode
n5	On	00	Blinking	00	Blinking

Step 2: Press "SW7" to send the project number offset command. The master module is displayed as follows:

LED1		LED2		LED3	
Function Code	Display Mode	Current Progress/Mode	Display Mode	Current Status	Display Mode
n5	On	00	On	OC	On

After 10 seconds, the system quits this mode and restores the normal operation mode.

**NOTE:** This function only needs to be set on the master system, which is the system with the centralized control address SA2 DIP switch being "00000". For details, see the "Centralized Control Address DIP Switch (SA2\_Addr-CC)" section.

### 1.3.4 Function Query Operations

Step 1: Open the commissioning window of the master unit panel.

Step 2: Power on the entire unit.

Step 3: Press "SW4" on the master unit to enter the query status.

Step 4: Select a function to be queried by pressing "SW1 (UP)" or "SW2 (DOWN)" on the master unit. By default, the A7 outdoor silent mode is displayed for query.

For example, select the A6 unit cooling/heating function. The display is as follows:

LED1		LED2		LED3	
Function Code	Display Mode	ODU Function Mode Code	Display Mode	ODU Function Mode Code	Display Mode
A6	On	nA	On	nA	On

ED1		LED2		LED3	
Function Code	Display Mode	Current Progress/Mode	Display Mode	Current Status	Display Mode
n8	Blinking	00	Blinking	00	Blinking

Press "SW7" and select the IDU project number query on the master unit. The master unit is displayed as follows. Other modules are displayed in normal status.

LED1		LED2		LED3	
Function Code	Display Mode	Current Progress/Mode	Display Mode	Current Status	Display Mode
n8	On	00	On	00	On

Regardless of the current display status of wired controllers or display panels of all IDUs, the current display status is all switched to the IDU project number. However, it does not influence the settings and operation status of outdoor and IDUs.

On the master unit, press "SW6" to return to the upper level. The IDU retains the project number display status.

On the master unit, press and hold "SW6" to quit the address display status for all IDUs and return to the upper level.

If no quit button operations are performed on the master unit for 30 minutes, the function setting automatically quits and the unit restores the current status.

Step 6: If the n9 IDU address query is selected, the display is as follows:

LED1		LED2		LED3	
Function Code	Display Mode	Number of IDUs (Thousands-place Hundreds-place)	Display Mode	Number of IDUs (Tens-place Ones-place)	Display Mode
n9	On	00	On	00	Blinking

The digital LED2 displays the number of IDUs (thousands-place hundreds-place) and the digital LED3 displays the number of IDUs (tens-place ones place). For example, if the number of IDUs is 75, "0075" is displayed.

If no button operations are performed on the master unit for five minutes, the function setting automatically quits and the unit restores the current status.

Note: The online IDU quantity query function applies to a single refrigerating system only.

Step 7: If the n6 fault query is selected, the display is as follows. Enter the to-be-confirmed status of fault query.

LED1		LED2		LED3	
Function Code	Display Mode	Current Progress/Mode	Display Mode	Current Status	Display Mode
n6	Blinking	00	Blinking	00	Blinking

Press "SW7" on the master unit to confirm fault query.

Select a fault to be queried by pressing "SW1 (UP)" or "SW2 (DOWN)". LED3 alternately displays the historical fault code and module address in an interval of one second in the sequence of fault records. LED2 displays the fault sequence number. If there not historical faults, LED2 and LED3 display "00" by

default. Up to five historical faults can be queried. The faults that can be queried are as follows:

Code		Code	
E1	High-pressure protection	PC	Current detection circuit failure of inverter compressor driver
E3	Low-pressure protection	P9	Inverter compressor out-of-step protection
U4	Lack of refrigerant protection	C2	Communication failure between the master unit and inverter compressor driver
E2	Discharge low-temperature protection	P8	Over-high temperature protection for inverter compressor driver module
E4	Compressor high discharge temperature protection	P7	Temperature sensor failure of inverter compressor driver module
J1	Compressor 1 overcurrent protection	PF	Charge circuit failure of inverter compressor driver
J9	Over-low pressure ratio protection	HL	DC bus line over-low voltage protection for inverter outdoor fan driver
J8	Over-high pressure ratio protection	HH	DC bus line over-high voltage protection for inverter outdoor fan driver
J7	Gas-mixing protection of 4-way valve	H6	Inverter outdoor fan driver IPM module protection
J2	Over-current protection of compressor 2	HJ	Inverter outdoor fan startup failure
PL	DC bus line over-low voltage protection for inverter compressor driver	HE	Inverter outdoor fan phase lack protection
PH	DC bus line over-high voltage protection for inverter compressor driver	H3	Inverter outdoor fan driver module reset
P6	Inverter compressor driver IPM module protection	H5	Inverter outdoor fan over-current protection
PJ	Inverter compressor startup failure	HC	Current detection circuit failure of inverter outdoor fan driver
PE	Inverter compressor phase lack protection	H9	Inverter outdoor fan out-of-step protection
P3	Inverter compressor driver module reset	C3	Communication failure between the master unit and inverter outdoor fan driver
P5	Inverter compressor over-current protection	H8	Over-high temperature protection for inverter outdoor fan driver module
		H7	Temperature sensor failure of inverter outdoor fan driver module

The display is as follows:

LED1		LED2		LED3	
Function Code	Display Mode	Fault Sequence	Display Mode	Current Status	Display Mode
n6	On	01	On	Historical fault/module address	Displayed alternately
n6	On	02	On		Displayed alternately
n6	On	03	On		Displayed alternately
n6	On	04	On		Displayed alternately
n6	On	05	On		Displayed alternately

"01-05" indicates the fault sequence from the earliest to the latest.

If there are less than five historical faults, LED2 and LED3 display "00" indicating there are no more historical faults after the last fault is displayed.

In fault query status, press and hold "SW7" for five seconds to clear all historical faults of the ODU.

Step 8: If the n7 parameter query is selected, the display is as follows. Enter the to-be-confirmed status of parameter query.

LED1		LED2		LED3	
Function Code	Display Mode	Current Progress/Mode	Display Mode	Current Status	Display Mode
n7	Blinking	00	Blinking	00	Blinking

On the master unit, press "SW7" to confirm parameter query and enter the module confirmation status for parameter query. The display is as follows:

LED1		LED2		LED3	
Function Code	Display Mode	Module Address	Display Mode	Current Status	Display Mode
n7	On	01	Blinking	00	Blinking
n7	On	02	Blinking	00	Blinking
n7	On	03	Blinking	00	Blinking
n7	On	04	Blinking	00	Blinking

Select a module for parameter query by pressing "SW1 (UP)" or "SW2 (DOWN)" and then press "SW7". The display is as follows:

LED1		LED2		LED3	
Function Code	Display Mode	Parameter Code	Display Mode	Current Status	Display Mode
n7	On	XX	On	Parameter value	Blinking

LED2 displays the parameter code of the module and LED3 displays the parameter value. Parameters are displayed in the following sequence. By default, the outdoor environment temperature value is displayed. Select a corresponding parameter value by pressing "SW1 (UP)" or "SW2 (DOWN)".

Parameter Code	Parameter Name	Unit	Remark
01	Outdoor environment temperature	°C	
02	Operation frequency of compressor 1	Hz	
03	Operation frequency of compressor 2	Hz	
04	Operation frequency of outdoor fan	Hz	
05	Module high-pressure	°C	
06	Module low-pressure	°C	
07	Discharge temperature of compressor 1	°C	
08	Discharge temperature of compressor 2	°C	
09	Discharge temperature of compressor 3	°C	This parameter is invalid for the GMV5 series.
10	Discharge temperature of compressor 4	°C	This parameter is invalid for the GMV5 series.
11	Discharge temperature of compressor 5	°C	This parameter is invalid for the GMV5 series.
12	Discharge temperature of compressor 6	°C	This parameter is invalid for the GMV5 series.
13	Operation frequency of compressor 3	Hz	This parameter is invalid for the GMV5 series.
14	Current value of compressor 1	A	
15	Current value of compressor 2	A	
16	Current value of compressor 3	A	This parameter is invalid for the GMV5 series.
17	Current value of compressor 4	A	This parameter is invalid for the GMV series.
18	Current value of compressor 5	A	This parameter is invalid for the GMV5 series.
19	Current value of compressor 6	A	This parameter is invalid for the GMV5 series.
20	Reserved		
21	Module temperature of compressor 1	°C	
22	Module temperature of compressor 2	°C	
23	Module temperature of outdoor fan 1	°C	
24	Module temperature of outdoor fan 2	°C	
25	Outdoor unit heating EXV1	PLS	

Parameter Code	Parameter Name	Unit	Remark
26	Outdoor unit heating EXV2	PLS	
27	Subcooler EXV	PLS	
28	Defrosting temperature	°C	
29	Liquid-extracting temperature of subcooler	°C	
30	Outlet temperature of accumulator	°C	
31	Oil return temperature	°C	This parameter is invalid for the GMV5 series.
32	Inlet-tube temperature of condenser	°C	This parameter is invalid for the GMV5 series.
33	Outlet temperature of condenser	°C	This parameter is invalid for the GMV5 series.

**NOTE:**

- ① If a parameter value is negative, LED3 circularly displays the negative code "nE" and the numeric value every one second. For example, for -30°C, LED3 alternately displays "nE" for one second and then "30" for another second.
- ② The discharge temperature and environment temperature are displayed as four-digit values, circularly displaying the higher two digits and the lower two digits. For example, if "01" and "15" are alternately displayed, it indicates 115°C. If "nE", "00", and "28" are alternately displayed, it indicates -28°C.
- ③ If a parameter is invalid for the unit, "00" is displayed.
- ④ If no button operations are performed on the master unit for five minutes, the function setting automatically quits and the unit restores the current status.

Step 9: If the nb ODU bar code query is selected, the display is as follows. Enter the to-be-confirmed status of ODU bar code query.

LED1		LED2		LED3	
Function Code	Display Mode	Current Progress/Mode	Display Mode	Current Status	Display Mode
nb	Blinking	00	Blinking	00	Blinking

Press "SW7" on the master unit to enter the next-level menu selection. The display is as follows:

LED1		LED2		LED3	
Function Code	Display Mode	Module Address	Display Mode	Current Status	Display Mode
nb	On	01	Blinking	00	Blinking
nb	On	02	Blinking	00	Blinking
nb	On	03	Blinking	00	Blinking
nb	On	04	Blinking	00	Blinking

Select a module for query by pressing "SW1 (▲)" or "SW2 (▼)" and then press "SW7". The display is as follows:

LED1		LED2		LED3	
Function Code	Display Mode	Parameter Code	Display Mode	Current Status	Display Mode
nb	On	Un/Pc	Blinking	-n	Blinking

**Note:** Un indicates the entire-unit bar code and Pc indicates the controller bar code.

After confirming the module, select a bar code sequence by pressing "SW1 (▲)" or "SW2 (▼)". The display sequence is as follows:

Entire-unit bar code (bits 1-13) and controller bar code (bits 1-13), that is, entire-unit bar code header → entire-unit bar code (bits 1-6) → entire-unit bar code (bits 7-12) → entire-unit bar code (bit 13) → controller bar code header → controller bar code (bits 1-6) → controller bar code (bits 7-12) → controller bar code (bit 13). The display is as follows:

LED1		LED2		LED3	
Parameter Code	Display Mode	Parameter Code	Display Mode	Parameter Code	Display Mode
Code	On	Code	On	Code	On

Example:

Entire-unit bar code: N1R0128150066

Controller bar code: N1M0128150067

The display sequence is as follows:

LED1		LED2		LED3	
Parameter Code	Display Mode	Parameter Code	Display Mode	Parameter Code	Display Mode
nb	On	Un	Blinking	-n	Blinking

↓

LED1		LED2		LED3	
Parameter Code	Display Mode	Parameter Code	Display Mode	Parameter Code	Display Mode
N1	On	R0	On	12	On

↓

LED1		LED2		LED3	
Parameter Code	Display Mode	Parameter Code	Display Mode	Parameter Code	Display Mode
81	On	50	On	06	On

↓

LED1		LED2		LED3	
Parameter Code	Display Mode	Parameter Code	Display Mode	Parameter Code	Display Mode
6X	On/Off	XX	Off	XX	Off

↓

LED1		LED2		LED3	
Parameter Code	Display Mode	Parameter Code	Display Mode	Parameter Code	Display Mode
nb	On	Pc	Blinking	-n	Blinking

↓

LED1		LED2		LED3	
Parameter Code	Display Mode	Parameter Code	Display Mode	Parameter Code	Display Mode
N1	On	M0	On	12	On

↓

LED1		LED2		LED3	
Parameter Code	Display Mode	Parameter Code	Display Mode	Parameter Code	Display Mode
81	On	50	On	06	On

↓

LED1		LED2		LED3	
Parameter Code	Display Mode	Parameter Code	Display Mode	Parameter Code	Display Mode
7X	On/Off	XX	Off	XX	Off

If a parameter is invalid for the unit, "00" is displayed.

On the master unit, press "SW6" to return to the upper level if there are two levels of menu. Press "SW4" to quit the query status.

If no button operations are performed on the master unit for five minutes, the function setting automatically quits and the unit restores the current status.

Step 4: In query status, press "SW4" to quit.

## 1.3.5. Basic Operations for Engineering Commissioning

### 1.3.5.1 Basic Operations

Basic Operations	Operation Method	Remark
Starting engineering commissioning	Press and hold "SW7" on the master unit for more than five seconds.	—
Selecting no-wired-controller commissioning mode	Press "SW4" and "SW5" simultaneously in any commissioning progress after the unit enters the commissioning status.	In this mode, the system does not detect the communication status between the IDU and wired controller any more. Commissioning can be performed on the IDU without configuring the wired controller.
Quitting engineering commissioning	In engineering commissioning status, press and hold "SW7" for more than five seconds on the master unit to quit commissioning.	—
Pausing engineering commissioning	In engineering commissioning status, press "SW6" on the master unit to retain the previous commissioning completion phase of the current commissioning phase.	This function is valid after step 9. For example, if receiving a pausing engineering commissioning signal during the process of "10. Pre-startup ODU valve status judging phase" in step 11, the system will restore the completion phase of "9. Pre-startup refrigerant judging phase" in step 10.
Continuing engineering commissioning	In engineering commissioning pause status, press "SW6" on the master unit to continue engineering commissioning.	—

### 1.3.5.2 Restoring Factory Settings

Restoring Factory Settings	Setting Method	Prompt for Successful Settings	Remark
Restoring setting 1	Press and hold "SW8" on the master unit for more than 10 seconds.	All LEDs blink for three seconds.	All factory settings of the ODU are restored and the unit waits for re-commissioning.
Restoring setting 2	Press and hold "SW3" and "SW8" on the master unit for more than 10 seconds.	All LEDs blink for five seconds.	Re-commissioning is not required. The number of outdoor and IDUs is memorized. Addresses of outdoor and IDUs are all cleared. All the other function settings are cleared.
Restoring setting 3	Press and hold "SW5" and "SW8" on the master unit for more than 10 seconds.	All LEDs blink for seven seconds.	Re-commissioning is not required. The number of outdoor and IDUs is memorized. Addresses of outdoor and IDUs retain the preceding settings. All the other function settings are cleared.

## ▲ CAUTION

• If above function settings are incorrect, unit will run abnormal and compressor may even be damaged.



## 2 COMMISSIONING PROCESS

### NOTICE!

- ① It is forbidden to directly connect the compressor with power supply and forcibly power it on during commissioning and maintenance.
- ② Engineering commissioning operations must be performed on the GMV5 serial unit. Otherwise, the unit cannot properly run.
- ③ Before commissioning is completed, the main board of ODU displays "module address 0F A0" and that of IDU displays "A0".
- ④ A module must be set to master module and only one can be set during commissioning.
- ⑤ An IDU must be set to master IDU and only one can be set during commissioning.
- ⑥ Other functions can use the factory settings if there are not special engineering requirements.

### 2.1 NECESSITY OF VRF ENGINEERING COMMISSIONING

Different from ordinary air conditioning units, the VRF system raises high design requirements and easily incurs operation-affected factors such as impurities and water during engineering installation. Due to the requirements on engineering design/installation complexity and high-precise system control, commissioning is mandatory after engineering installation. Only a qualified unit can be delivered for use.

### 2.2 REQUIRED FILES AND TOOLS FOR ENGINEERING COMMISSIONING

#### 2.2.1 Required Tools for Engineering Commissioning of GREE VRF

Inner hexagon spanner	Digital thermometer
Shifting spanner	Noise meter
Cross screwdriver	Clamp meter
Straight screwdriver	Digital multimeter
Vacuum pump	Electricity meter
Electronic balance	Timer
System high and low pressure gauges for corresponding refrigerants	Step ladder
Wind-speed transmitter	...

The GMV5 VRF provides two commissioning methods. One is to perform commissioning by pressing buttons on the main board of ODU. The other is to perform commissioning on a PC through professional software. Parameters of the ODU and IDU can be simultaneously displayed with the second method. (For details about these methods, refer to respective instructions.)

#### 2.2.2 Commissioning Files

The following commissioning files are required to record installation and commissioning of units: pre-commissioning scheme determination meeting minutes, commissioning personnel record tables, commissioning system appearance check record tables, commissioning data record tables, and commissioning reports. See attached tables for file formats.

## 2.3 ENGINEERING COMMISSIONING PROCEDURES

### 2.3.1 Pre-commissioning Preparations

#### 2.3.1.1 Overall Commissioning Plan

Before commissioning, the person-in-charge should learn about the overall engineering progress plan, overall workload of engineering commissioning, possible influence factors in achieving the commissioning progress, and required labors and materials.

#### 2.3.1.2 Composition of Commissioning Members

Commissioning members comprise aftersales commissioning personnel and installation personnel.

All commissioning participants must take part in professional training courses before unit commissioning. All participants can be grouped as required and each group should include at least professional commissioning personnel and assistants.

#### 2.3.1.3 Preparations of Commissioning Tools and Instruments

- (1) Make sure that the following tools or instruments are prepared before commissioning.
- (2) Make sure that the commissioning software is correct before commissioning.
- (3) The professional aftersales commissioning software provided by GREE should be used for commissioning of GREE VRF system.
- (4) Make sure that all required files and parameter records are prepared.

### 2.3.2 Pre-commissioning Check

Installation environment check covers the heat exchange environment of unit and electromagnetic radiant components. All requirements should comply with national and local electrical standards. For any installation incompliance, records should be made for providing an analysis basis during refrigerating system testing.

#### 2.3.2.1 Installation Appearance Check

Installation appearance check covers whether pipeline installation complies with specifications, whether refrigerant pipes and condensing drainage pipes are thermal insulated, and whether

Refrigerant pipes should be tidily installed, with outdoor and indoor disperse pipes leaning in the required scope. For any installation incompliance, records should be made for providing an analysis basis during refrigerating system testing.

Refrigerant pipes and condensing drainage pipes should not be exposed. If any pipe is exposed, an immediate amendment is required to avoid serious loss.

#### 2.3.2.2 Refrigerating System Check

- 1) Before commissioning, make sure that the stop valve of each module reaches the maximum opening degree. Check whether there is any refrigerator oil leakage around the valve. If there is, immediately check for leakage with soap bubbles or leak detectors. If confirming that leakage exists, immediately stop commissioning and solve the problem before continuing commissioning.

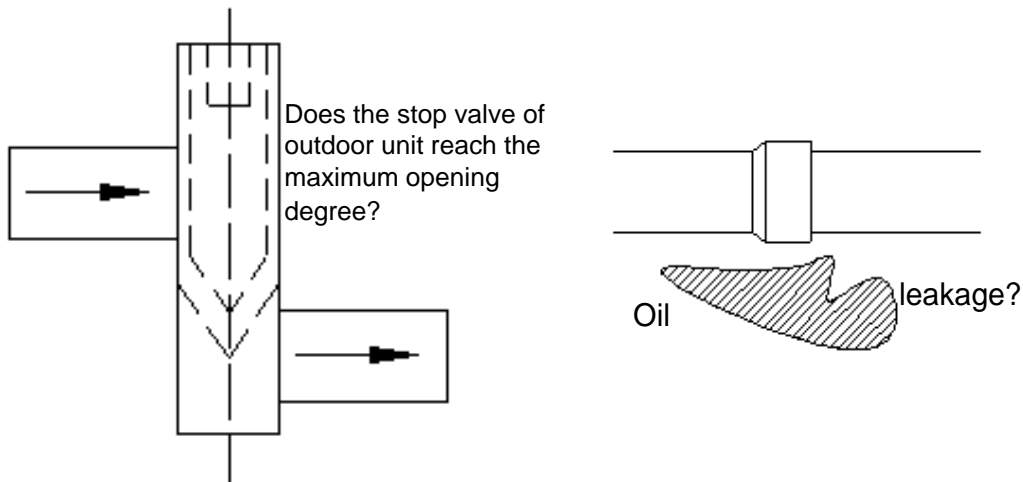

## 2) Check system refrigerants before startup

Before the system is started, connect the liquid-tube valve of ODU with a high pressure gauge and the air-tube valve of ODU with a low pressure gauge, and then read their values. In this case, high pressure and low pressure of the system should be in balance status, and the difference between the saturation temperature corresponding to the balanced pressure value and the environment temperature (the higher in outdoor and indoor temperatures is taken as environment temperature) should not be larger than 5°C K. If the difference is larger than 5°C K, it is required to check the ODU for leakage.

**NOTE:** Guarantee that the system has never been started before this test. Otherwise, the high pressure value will be over-higher than the environment temperature or the low pressure value will be over-lower than the environment temperature.

### Example:

The outdoor environment temperature is 30°C(86°F) and the indoor environment temperature is 28°C(82°F). The pressure gauges connected with the system show that the high pressure value is 28°C(82°F) and the low pressure value is 27°C(81°F). The difference between the outdoor environment temperature and either pressure value is less than 5°C K. It indicates that the system standby pressure is normal.

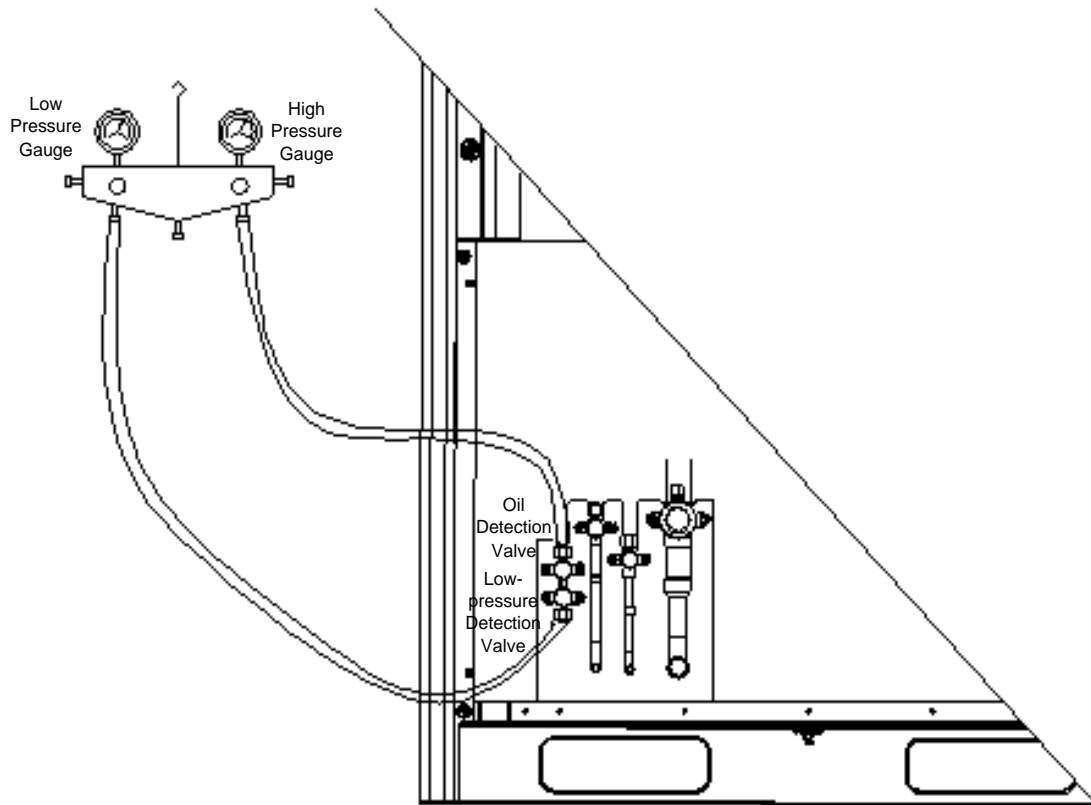

### 2.3.2.3 Electrical System Check

- 1) Check for high electromagnetic interference, dusts, and acidic or alkaline gas in the unit environment.
  - a. The air conditioning unit can neither share the same power supply system with the equipment containing variable-frequency drives, nor reside near the equipment generating high electromagnetic interference. Otherwise, the air conditioning unit may fail to properly work due to interference. If this case exists, records should be made. In the case of serious influence, the air conditioning unit must be relocated or relevant measures must be taken.
  - b. Prevent acidic or alkaline gas/liquid from rusting cables of the air conditioning unit.

#### 2) Check the installation appearance of power cables.

Check whether power cables of indoor and ODU are installed according to vendor requirements and whether cable connectors are reliably connected. Except the connection part of patch panels, wire exposure is not allowed on any connection part of power cables.

#### 3) Check the power capacity required for the unit.

The air conditioning unit works at a current much larger than the rated current (the working current changes in a large scope in different conditions). The power grid provides unstable voltages and the line power factor decreases. Therefore, the power capacity should not be less than the maximum power of the unit.

#### 4) Check air switches and fuse links for their models and using methods.

- a. Commercial air conditioning units must be installed with independent air switches, fuse links, and similar protectors. Reasonable models and using methods should be selected for air switches and fuse links.

Remarks:

a1. Air switches work for overload and short-circuit protection. Air switches provide a less breaking current than fuse links and air switches react more slowly than fuse links. The advantage of air switches is that they can be manually reset after a protection action.

a2. Fuse links only work for short-circuit protection. They provide a large breaking current and act slowly. However, fuses must be replaced after a protection action.

b. Select air switch models according to the power cable diameter and air switch specifications. In general, the rated current of air switches should be larger than or equal to the load current calculated based on the line, and less than or equal to the persistent current rating allowed by the conductor.

5) Check components in the electric box.

In the case of unit power-off, visually check whether any component in the electric box drops during transportation. Then, check whether any component or cable is loose or drops by hand. For a large-scale unit, power cable terminals of the patch panel and cable terminals connected with connectors must be tightened with a sleeve spanner or screwdriver, and tightened once more after two months of normal operation. Auxiliary contacts of AC connectors cannot be removed because they have been debugged upon factory departure.

6) Check the input power.

a. Power consistency check: Measure the power supply to be connected with the air conditioning unit for its voltage, frequency, three-phase voltage unbalance factor, and frequency offset. Specifications of the power supply should be consistent with power specifications displayed on the unit nameplate. The fluctuation range of voltage should be within  $\pm 10\%$ .

b. Phase sequence check:

b1. After powering on the unit, measure the grounded voltage value of N-bit on the power patch panel and the voltage value between every two of L1, L2, and L3 bits. In general, the voltage between N-bit and L1/L2/L3-bit should approach 220 V and the voltage between every two of L1, L2, and L3 bits should approach 380 V. If the measurement result does not match the above-mentioned normal value, check whether the external power cable is inversely connected between the N wire and one of L wires.

b2. Observe the code displayed on the digital LED of the main board AP1. If the fault code "U3" is displayed, it indicates that the phase sequence of the external power cable connected with the air conditioning unit is incorrect. Power off the unit and exchange any two phases among L1, L2, and L3 bits on one end of the external power cable. Power on the unit and observe the code again. The fault code "U3" should disappear.

### 2.3.2.4 Communication System Check

1) The following communication contents must be checked again before commissioning:

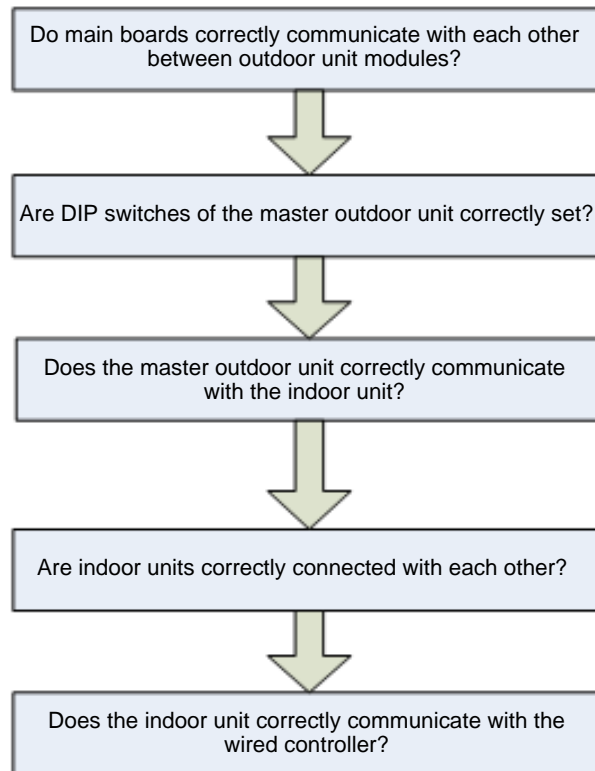

2) Communication cables cannot be laid out in the same trough as power cables. Communication cables should be independently laid out in hard fire-resistant PVC tubes. The parallel spacing between communication cables and strong electric wires should be larger than 20 cm.

### 2.3.2.5 Installation and Master of Commissioning Software

### 2.3.2.6 Spot Check

Spot Check for GMV5 Commissioning		
SN	Spot Check Item	Qualified
1	Is the engineering design diagram complete?	
2	Does the construction comply with the design diagram?	
3	Is the rated capacity of the IDU/ODU of a single refrigerating system within 50%-135%?	
4	Is the number of connected IDUs in a single refrigerating system within 80?	
5	Is the access capacity of a fresh-air unit within 30%?	
6	Does the difference of level between IDUs and ODUs comply with unit design requirements?	
7	Does the difference of level between IDUs comply with unit design requirements?	
9	Are long pipes of IDUs and ODUs less than or equal to 165 m(541ft)?	
10	Is the total length of pipes less than 1000 m(3280ft)?	
11	Is the spacing between the ODU and the first disperse pipe larger than 90 m(295ft)? If yes, is the corresponding pipe diameter increased?	
12	Is the spacing between the IDU and the nearest disperse pipe larger than 10 m(33ft)? If yes, is the corresponding pipe diameter increased?	
13	Does the wall thickness of copper tubes meet design requirements?	
14	Are disperse pipes horizontal or vertical?	
15	Does the diameter of cables connected with IDUs and ODUs comply with unit design requirements?	

Spot Check for GMV5 Commissioning		
SN	Spot Check Item	Qualified
16	Do the circuit breaker and leakage switch comply with unit design requirements?	
17	Is the spacing between the power cable and the TV set larger than 1 m?	
18	Do communication cable materials comply with unit design requirements?	
19	Are all communication cables of IDUs and ODUs serially connected?	
20	Is the last-communicating IDU installed with a communication-matched resistance?	
21	What is the load of the selected IDU model?	
22	Is the foundation of ODU firm? Do shock absorption and water drainage comply with requirements?	
23	Are basic modules installed on the same horizontal line?	
24	Does the drainage pipe of IDU retain a 1/100 ratio of slope?	
26	Is the drainage of IDU smooth?	
27	Does a U-shaped trap exist in the drainage pipe of IDU?	
28	Are the air outlet and air return vent of IDU connected with soft connectors? Is a plenum chamber installed for air return?	
29	Is the water pipe of IDU installed with an air exhaust vent?	
30	Is "MASTER" stuck to the wired controller or panel of the master IDU?	
31	Does appending refrigerants to the system comply with requirements?	
32	Does the ODU run with static pressure? Has a static pressure value been set?	
33	Has the ODU been preheated for more than eight hours before commissioning?	

## 2.3.3 Commissioning Operation

### 2.3.3.1 Precautions

- (1) Before starting commissioning, make sure that the unit compressor has been preheated for more than eight hours and check whether preheating is normal by touching. Commissioning can be started only when preheating is normal. Otherwise, the compressor may be damaged. Commissioning must be performed or guided by professional personnel.

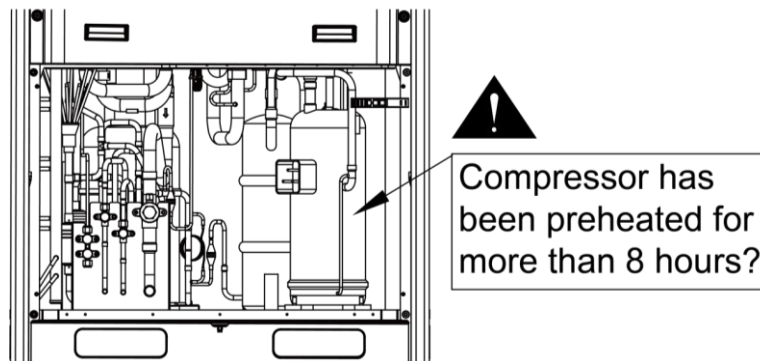

### **CAUTION**

- Before starting commissioning, the outdoor unit must be power-on for more than 8 hours. Otherwise, compressor may be damaged.
- During daily operation, please keep the outdoor unit power-on at any time.
- If unit is power-off for more than 24 hours, it must be preheated for at least 8 hours before operation.

- (2) When unit commissioning is started, the system automatically selects an operation mode

according to the environment temperature:

Cooling mode when the outdoor environment temperature is higher than 20°C(68°F).

Heating mode when the outdoor environment temperature is lower than 20°C(68°F).

(3) Before starting commissioning, make sure again that stop valves of all basic modules of the ODU have been completely opened.

(4) During commissioning, the front panel of ODU must be completely covered. Otherwise, commissioning accuracy may be affected (as shown in the following figure).

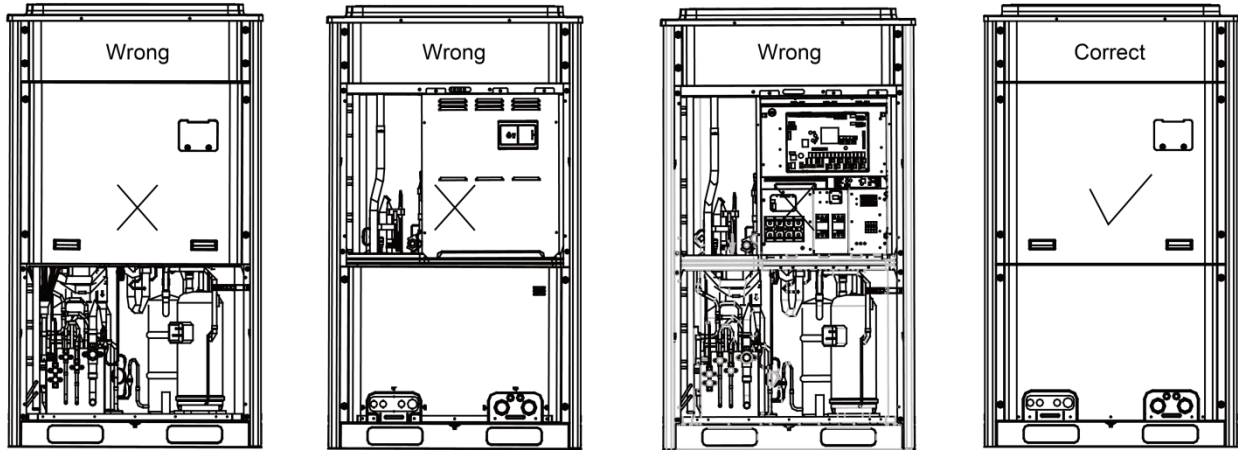

(5) Before commissioning, make sure that appending refrigerants to pipes has finished completely or for more than 70%.

(6) The following table describes progress display of each phase during commissioning:

Progress Description for Commissioning Phases							
—	Commissioning Code		Progress Code		Status Code		Meaning
Progress	LED1		LED2		LED3		
	Code	Display Status	Code	Display Status	Code	Display Status	
01_Master unit setting detection	db	On	01	On	A0	On	The system is in non-commissioning status.
	db	On	01	On	CC	On	The system does not set any master unit, and a master unit should be set.
	db	On	01	On	CF	On	The system sets more than two master units, and a master unit should be set again.
	db	On	01	On	OC	On	The system successfully sets a master unit and automatically enters the next step.
02_Unit address assignment	db	On	02	On	Ad	Blinking	The system is assigning addresses.
	db	On	02	On	L7	Blinking	There is not any master IDU, and a master IDU should be set through the commissioning software. If no master IDU is set within one minute, the system will automatically set one.
	db	On	02	On	OC	On	The system successfully assigns addresses and automatically enters the next step.



Progress Description for Commissioning Phases							
—	Commissioning Code		Progress Code		Status Code		Meaning
Progress	LED1		LED2		LED3		
	Code	Display Status	Code	Display Status	Code	Display Status	
03_Basic module quantity confirmation for ODU	db	On	03	On	01-04	Blinking	LED3 displays the module quantity, which should be manually confirmed.
	db	On	03	On	OC	On	The system confirms the module quantity and automatically enters the next step.
04_Indoor unit quantity confirmation	db	On	04	On	01-80	Blinking	LED3 displays the IDU quantity, which should be manually confirmed.
	db	On	04	On	OC	On	The system confirms the IDU quantity and automatically enters the next step.
05_Internal communication detection for basic modules	db	On	05	On	C2	On	The system detects communication failure between master unit and inverter compressor driver.
	db	On	05	On	C3	On	The system detects communication failure between master unit and inverter fan driver.
	db	On	05	On	CH	On	The rated capacity ratio is over-high between IDUs and ODUs.
	db	On	05	On	CL	On	The rated capacity ratio is over-low between IDUs and ODUs.
	db	On	05	On	OC	On	The system completes detection and automatically enters the next step.
06_Internal component detection for basic modules	db	On	06	On	Corresponding fault code	On	The system detects component failure of ODU.
	db	On	06	On	OC	On	The system detects that no ODU component fails and automatically enters the next step.
07_Component detection for IDU	db	On	07	On	XXXX/ Corresponding fault code	On	The system detects component failure of IDU. "XXXX" indicates the project number of the faulty IDU. The corresponding fault code is displayed after three seconds. For example, if a d5 fault occurs on IDU 100, LED3 will circularly display "01", "00" (two seconds later), and "d5" (two seconds later).
	db	On	07	On	OC	On	The system detects that no IDU component fails and automatically enters the next step.

Progress Description for Commissioning Phases							Meaning
—	Commissioning Code		Progress Code		Status Code		
Progress	LED1		LED2		LED3		
	Code	Display Status	Code	Display Status	Code	Display Status	
08_Compressor preheating confirmation	db	On	08	On	U0	On	The system gives a prompt if the compressor preheating period is less than eight hours.
	db	On	08	On	OC	On	The system detects that the compressor preheating period is more than eight hours and automatically enters the next step.
09_Pre-startup refrigerant detection	db	On	09	On	U4	On	The system detects insufficient refrigerants and stops to balance the pressure lower than 0.3 MPa.
	db	On	09	On	OC	On	The system detects that refrigerants are normal and automatically enters the next step.
10_Pre-startup ODU valve status detection	db	On	10	On	ON	On	Outdoor unit valves are being opened.
	db	On	10	On	U6	On	Outdoor unit valves have not been completely opened.
	db	On	10	On	OC	On	Outdoor unit valves have been properly opened.
11_Manually calculated refrigerant perfusion status	db	On	11	On	AE	On	The refrigerant perfusion status is manually calculated (appended refrigerants must be accurately calculated).
12_Unit commissioning startup confirmation	db	On	12	On	AP	Blinking	The system waits for a unit commissioning startup command.
	db	On	12	On	AE	On	The unit is set to manually-calculated refrigerant perfusion commissioning operation status.
13_	—	—	—	—	—	—	No meaning.
14_	—	—	—	—	—	—	No meaning.
15_Cooling operation by manual perfusion	db	On	15	On	AC	On	The system is in cooling-mode commissioning operation (the system automatically selects the commissioning operation mode without needing manual settings).
	db	On	15	On	Corresponding fault code	On	A fault occurs on the cooling-mode commissioning operation.
	db	On	15	On	J0	On	A fault occurs on other modules during the cooling-mode commissioning operation.
	db	On	15	On	U9	On	A fault occurs on ODU pipes or valves.
	db	On	15	On	XXXX/U8	On	The system detects pipe failure of IDU. "XXXX" indicates the project number of the faulty IDU. The fault code "U8" is displayed after three seconds. For example, if a U8 fault occurs on IDU 100, LED3 will circularly display "01", "00" (two seconds later), and "U8" (two seconds later).

Progress Description for Commissioning Phases							
—	Commissioning Code		Progress Code		Status Code		Meaning
Progress	LED1		LED2		LED3		
	Code	Display Status	Code	Display Status	Code	Display Status	
16_Heating operation by manual perfusion	db	On	16	On	AH	On	The system is in heating-mode commissioning operation (the system automatically selects the commissioning operation mode without needing manual settings).
	db	On	16	On	Corresponding fault code	On	A fault occurs on the heating-mode commissioning operation.
	db	On	16	On	J0	On	A fault occurs on other modules during the heating-mode commissioning operation.
	db	On	16	On	U9	On	A fault occurs on ODU pipes or valves.
	db	On	16	On	XXXX/U8	On	The system detects pipe failure of IDU. "XXXX" indicates the project number of the faulty IDU. The fault code "U8" is displayed after three seconds. For example, if a U8 fault occurs on IDU 100, LED3 will circularly display "01", "00" (two seconds later), and "U8" (two seconds later).
17_Commissioning completion status	01-04	On	OF	On	OF	On	The unit has completed commissioning and in standby status. LED1 displays the module address; LED2 and LED3 display "OF".

**NOTE:** In commissioning status, press and hold "SW3" and "SW4" simultaneously for more than five seconds to enter the no-wired-controller commissioning mode. In this mode, the system does not detect the communication status between the wired controller and IDU.

### 2.3.3.2 Commissioning Operation Mode

The VRF provides three commissioning methods.

- ① Commissioning through the main board of ODU
- ② Commissioning on a PC through professional software. Parameters of the ODU and IDU can be simultaneously displayed and historical data can be stored and queried with the second method. (For details about these methods, refer to respective instructions.)
- ③ Commissioning through the Portable Commissioning Tool (For details about these methods, refer to respective instructions)

#### (1) Commissioning Through the Main Board of ODU

When unit commissioning is performed through the main board of ODU, the main board provides the following commissioning operation functions:

Step 1: Completely cover the front panel of ODU and open commissioning windows of all basic modules.

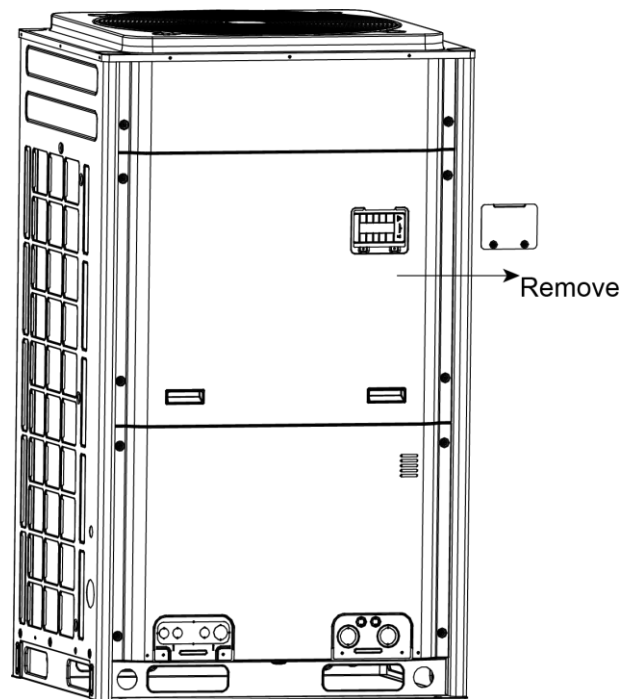

Step 2: In power-off status of ODU, set the ODU to a corresponding static pressure mode according to static pressure design requirements for outdoor engineering. For details about the setting method, see the "Outdoor Fan Static Pressure Setting DIP Switch (SA6\_ESP\_S)" section. If there are not static pressure requirements, retain the factory settings.

Step 3: In power-off status of ODU, set one module of ODU to master unit and other modules to sub-modules. For details about the setting method, see the "Master Unit Setting DIP Switch (SA8\_MASTER-S)" section.

Step 4: If centralized control is required, set the centralized control address in power-off status of ODU. For details about the setting method, see the "Centralized Control Address DIP Switch (SA2\_Addr-CC)" section. If centralized control is not required, retain the factory settings.

Step 5: Power on all outdoor and IDUs. If LED3 displays "A0" on main boards of all modules of ODU and the wired controller of each IDU displays "A0", it indicates that the unit is in non-commissioning status.



LED3

Step 6: Find the module with its address being "01", which is the master unit. On the master unit, press and hold "SW7" for more than five seconds to enter unit commissioning.

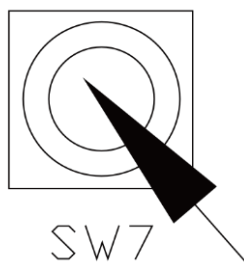

Step 7: Wait for the unit to automatically operate commissioning steps 01 and 02.

Exception 1: If the master unit is incorrectly set in step 01, the following faults are displayed in step 01:

Progress	Commissioning Code		Progress Code		Status Code		Meaning
	LED1		LED2		LED3		
	Code	Display Status	Code	Display Status	Code	Display Status	
01_Master unit settings	db	On	01	On	CC	On	The system does not set any master unit, and a master unit should be set.
	db	On	01	On	CF	On	The system sets more than two master units, and a master unit should be set again.
	db	On	01	On	OC	On	The system successfully sets a master unit and automatically enters the next step.

According to the above fault symptoms, set the master unit again by referring to the setting method in the "Master Unit Setting DIP Switch (SA8\_MASTER-S)" section. Then enter unit commissioning again.

Exception 2: If no master IDU is detected in step 02, the following faults are displayed in step 02:

LED1		LED2		LED3	
Function Code	Display Mode	Current Progress	Display Mode	Current Status	Display Mode
db	On	02	On	L7	Blinking

In this case, all buttons are invalid. Users can set the master IDU through the commissioning software, wired controller, or commissioning remote controller within one minute. If no master IDU is set within one minute, the system will automatically set a master IDU. Then the system automatically enters the next step.

Step 7: When the unit runs to step 03, users need to manually confirm the number of outdoor modules. The main board of each module is displayed as follows:

Progress	Commissioning Code		Progress Code		Status Code	
	LED1		LED2		LED3	
	Code	Display Status	Code	Display Status	Code	Display Status
03_Module quantity confirmation	db	On	03	On	Module quantity	Blinking

If the displayed quantity is consistent with the number of actually connected modules, press "SW7" on the master unit to confirm. The main board is displayed as follows and the unit automatically enters commissioning step 04.

Progress	Commissioning Code		Progress Code		Status Code	
	LED1		LED2		LED3	
	Code	Display Status	Code	Display Status	Code	Display Status
03_Module quantity confirmation	db	On	03	On	OC	On

If the displayed quantity is inconsistent with the number of actually connected modules, check whether communication cables are correctly connected between modules in power-off status. Then perform commissioning again.



- It is very important to correctly confirm the number of ODUs. If the confirmed quantity is inconsistent with the actual quantity, the system may improperly run.

Step 8: When the unit runs to step 04, users need to manually confirm the number of indoor modules. The main board of each module is displayed as follows:

Progress	Commissioning Code		Progress Code		Status Code	
	LED1		LED2		LED3	
	Code	Display Status	Code	Display Status	Code	Display Status
04_Indoor unit quantity confirmation	db	On	04	On	Number of connected IDUs	Blinking

If the displayed quantity is consistent with the number of actually connected modules, press "SW7" on the master unit to confirm. The main board is displayed as follows and the unit automatically enters the next commissioning step.

Progress	Commissioning Code		Progress Code		Status Code	
	LED1		LED2		LED3	
	Code	Display Status	Code	Display Status	Code	Display Status
04_Indoor unit quantity confirmation	db	On	04	On	OC	On



- It is very important to correctly confirm the number of IDUs. If the confirmed quantity is inconsistent with the actual quantity, the system may improperly run.

Step 9: Unit commissioning step 05 is internal communication detection.

If no exception is detected, the main board is displayed as follows and the unit automatically enters the next commissioning step.

Progress	Commissioning Code		Progress Code		Status Code		Meaning
	LED1		LED2		LED3		
	Code	Display Status	Code	Display Status	Code	Display Status	
05_Internal communication detection	db	On	05	On	OC	On	The system completes detection and automatically enters the next step.

If an exception is detected, the unit retains the current status and waits for manual troubleshooting. Corresponding faults include:

Progress	Commissioning Code		Progress Code		Status Code		Meaning
	LED1		LED2		LED3		
	Code	Display Status	Code	Display Status	Code	Display Status	
05_Internal communication detection	db	On	05	On	C2	On	The system detects communication failure between master unit and inverter compressor driver.
	db	On	05	On	C3	On	The system detects communication failure between master unit and inverter fan driver.
	db	On	05	On	CH	On	The rated capacity ratio is over-high between indoor and ODUs.
	db	On	05	On	CL	On	The rated capacity ratio is over-low between indoor and ODUs.

For details about the above troubleshooting method, refer to the "Troubleshooting Method" part.

Step 10: Unit commissioning step 06 is component detection for ODU.

If no exception is detected, the main board is displayed as follows and the unit automatically enters the next commissioning step.

Progress	Commissioning Code		Progress Code		Status Code		Meaning
	LED1		LED2		LED3		
	Code	Display Status	Code	Display Status	Code	Display Status	
06_Component detection for ODU	db	On	06	On	OC	On	The system detects that no ODU component fails and automatically enters the next step.

If an exception is detected, the unit retains the current status and waits for manual troubleshooting.

Corresponding faults include:

Progress	Commissioning Code		Progress Code		Status Code		Meaning
	LED1		LED2		LED3		
	Code	Display Status	Code	Display Status	Code	Display Status	
06_Component detection for ODU	db	On	06	On	Corresponding fault code	On	The system detects component failure of ODU.

For details about the above troubleshooting method, refer to the "Troubleshooting Method" part.

Step 11: Unit commissioning step 07 is component detection for IDU.

If no exception is detected, the main board is displayed as follows and the unit automatically enters the next commissioning step.

Progress	Commissioning Code		Progress Code		Status Code		Meaning
	LED1		LED2		LED3		
	Code	Display Status	Code	Display Status	Code	Display Status	
07_Component detection for IDU	db	On	07	On	OC	On	The system detects that no IDU component fails and automatically enters the next step.

If an exception is detected, the unit retains the current status and waits for manual troubleshooting.

Corresponding faults include:

Progress	Commissioning Code		Progress Code		Status Code		Meaning
	LED1		LED2		LED3		
	Code	Display Status	Code	Display Status	Code	Display Status	
07_Component detection for IDU	db	On	07	On	XXXX/ Corresponding fault code	On	The system detects component failure of IDU.

"XXXX" indicates the project number of the faulty IDU. The corresponding fault code is displayed after three seconds. For example, if a d5 fault occurs on IDU 100, LED3 will circularly display "01", "00" (two seconds later), and "d5" (two seconds later).

For details about the above troubleshooting method, refer to the "Troubleshooting Method" part.

Step 12: Unit commissioning step 08 is compressor preheating confirmation.

If it is detected that the compressor preheating period is more than eight hours, the main board is displayed as follows and the unit automatically enters the next step.

Progress	Commissioning Code		Progress Code		Status Code		Meaning
	LED1		LED2		LED3		
	Code	Display Status	Code	Display Status	Code	Display Status	
08_Compressor preheating confirmation	db	On	08	On	OC	On	The system detects that the compressor preheating period is more than eight hours and automatically enters the next step.

If it is detected that the compressor preheating period is less than eight hours, an exception is prompted and the main board is displayed as follows.

Progress	Commissioning Code		Progress Code		Status Code		Meaning
	LED1		LED2		LED3		
	Code	Display Status	Code	Display Status	Code	Display Status	
08_Compressor preheating confirmation	db	On	08	On	U0	On	The system gives a prompt if the compressor preheating period is less than eight hours.

## ▲ CAUTION

- Before starting commissioning, the outdoor unit must be power-on for more than 8 hours. Otherwise, compressor may be damaged.
- During daily operation, please keep the outdoor unit power-on at any time.
- If unit is power-off for more than 24 hours, it must be preheated for at least 8 hours before operation.

Step 13: Unit commissioning step 09 is pre-startup refrigerant confirmation.

If the refrigerant volume meets the system startup requirements, the main board is displayed as follows and the unit automatically enters the next commissioning step.



Progress	Commissioning Code		Progress Code		Status Code		Meaning
	LED1		LED2		LED3		
	Code	Display Status	Code	Display Status	Code	Display Status	
09_Pre-startup refrigerant detection	db	On	09	On	0C	On	The system detects that refrigerants are normal and automatically enters the next step.

If no refrigerant exists in the system or the refrigerant volume does not meet the system startup requirements, "U4 lack of refrigerant protection" is prompted and the main board is displayed as follows. The unit cannot enter the next commissioning step. In this case, check for leakage or append refrigerants till the exception disappears.

Progress	Commissioning Code		Progress Code		Status Code		Meaning
	LED1		LED2		LED3		
	Code	Display Status	Code	Display Status	Code	Display Status	
09_Pre-startup refrigerant detection	db	On	09	On	U4	On	The system detects insufficient refrigerants and stops to balance the pressure lower than 0.3 MPa.

Step 14: Unit commissioning step 10 is pre-startup ODU valve status detection.

If the master unit is displayed as follows, it indicates that the unit is being enabled.

Progress	Commissioning Code		Progress Code		Status Code		Meaning
	LED1		LED2		LED3		
	Code	Display Status	Code	Display Status	Code	Display Status	
10_Pre-startup ODU valve status detection	db	On	10	On	ON	On	Outdoor unit valves are being opened.

If the master unit is displayed as follows, it is required to check again whether the ODU valves are completely opened.

Progress	Commissioning Code		Progress Code		Status Code		Meaning
	LED1		LED2		LED3		
	Code	Display Status	Code	Display Status	Code	Display Status	
10_Pre-startup ODU valve status detection	db	On	10	On	U6	On	It is required to check again whether the ODU valves are completely opened.

After confirming that all valves are completely opened, press "SW7" to enter the next commissioning step.

If it is detected that the unit valve status is normal, the main board is displayed as follows and the unit automatically enters the next commissioning step.

Progress	Commissioning Code		Progress Code		Status Code		Meaning
	LED1		LED2		LED3		
	Code	Display Status	Code	Display Status	Code	Display Status	
10_Pre-startup ODU valve status detection	db	On	10	On	OC	On	Outdoor unit valves have been properly opened.

Step 15: Unit commissioning step 11 is manually calculated refrigerant perfusion status.

Without operations, the system gives a function prompt and automatically enters the next step.

Step 16: Unit commissioning step 12 is unit commissioning startup confirmation.

To avoid enabling the unit before all preparations are completed, it is required to confirm again whether to enable the unit.

If the master unit is displayed as follows, it indicates that the unit is waiting for enabling confirmation.

Progress	Commissioning Code		Progress Code		Status Code		Meaning
	LED1		LED2		LED3		
	Code	Display Status	Code	Display Status	Code	Display Status	
12_Unit commissioning startup confirmation	db	On	12	On	AP	Blinking	The system waits for a unit commissioning startup command.

If it is confirmed to enable the unit, press "SW7". The main board is displayed as follows and the unit automatically enters the next commissioning step.

Progress	Commissioning Code		Progress Code		Status Code		Meaning
	LED1		LED2		LED3		
	Code	Display Status	Code	Display Status	Code	Display Status	
12_Unit commissioning startup confirmation	db	On	12	On	AE	On	The unit is set to manually-calculated refrigerant perfusion commissioning status.

Step 17: After unit startup confirmation, the system automatically selects the cooling or heating mode according to the environment temperature.

A. If the system selects the cooling mode, the main board is displayed as follows:

Progress	Commissioning Code		Progress Code		Status Code		Meaning
	LED1		LED2		LED3		
	Code	Display Status	Code	Display Status	Code	Display Status	
15_Cooling commissioning operation	db	On	15	On	AC	On	The system is in cooling-mode commissioning operation (the system automatically selects the commissioning operation mode without needing manual settings).
	db	On	15	On	Corresponding fault code	On	A fault occurs on the cooling-mode commissioning operation.
	db	On	15	On	J0	On	A fault occurs on other modules during the cooling-mode commissioning operation.
	db	On	15	On	U9	On	A fault occurs on ODU pipes.
	db	On	15	On	XXXX/U8	On	The system detects pipe failure of IDU. "XXXX" indicates the project number of the faulty IDU. The fault code "U8" is displayed after three seconds. For example, if a U8 fault occurs on IDU 100, LED3 will circularly display "01", "00" (two seconds later), and "U8" (two seconds later).

B. If the system selects the heating mode, the main board is displayed as follows:

Progress	Commissioning Code		Progress Code		Status Code		Meaning
	LED1		LED2		LED3		
	Code	Display Status	Code	Display Status	Code	Display Status	
16_Heating commissioning operation	db	On	16	On	AH	On	The system is in heating-mode commissioning operation (the system automatically selects the commissioning operation mode without needing manual settings).
	db	On	16	On	Corresponding fault code	On	A fault occurs on the heating-mode commissioning operation.
	db	On	16	On	J0	On	A fault occurs on other modules during the heating-mode commissioning operation.
	db	On	16	On	U9	On	A fault occurs on ODU pipes.
	db	On	16	On	XXXX/U8	On	The system detects pipe failure of IDU. "XXXX" indicates the project number of the faulty IDU. The fault code "U8" is displayed after three seconds. For example, if a U8 fault occurs on IDU 100, LED3 will circularly display "01", "00" (two seconds later), and "U8" (two seconds later).

Step 18: If no exception occurs when the unit continuously operates for 60 minutes, the system automatically confirms commissioning completion, stops the entire unit, and restores the standby status. The main board is displayed as follows:

Progress	Commissioning Code		Progress Code		Status Code		Meaning
	LED1		LED2		LED3		
	Code	Display Status	Code	Display Status	Code	Display Status	
17_Commissioning completion status	01~04	On	OF	On	OF	On	The unit has completed commissioning and in standby status. LED1 displays the module address; LED2 and LED3 display "OF".

Step 19: After unit commissioning is completed, set unit functions according to the actual engineering requirements on functions. For details about the setting method, refer to the "System Function Setting Method" part. Skip this step if there are not special requirements.

Step 20: Deliver the unit for use and let users know the precautions.

#### (2) Commissioning Through the Commissioning Software

Step 1: Install commissioning software to the computer and connect monitoring communication cables (for details about the operation method, see the "GREE Central Air Conditioning Commissioning Software" section).

Step 2: Completely cover the front panel of ODU.

Step 3: In power-off status of ODU, set the ODU to a corresponding static pressure mode according to static pressure design requirements for outdoor engineering. For details about the setting method, see the "Outdoor Fan Static Pressure Setting DIP Switch (SA6\_ESP\_S)" section.

Step 4: In power-off status of ODU, set one module of ODU to master unit. For details about the setting method, see the "Master Unit Setting DIP Switch (SA8\_MASTER-S)" section.

Step 5: Power on all outdoor and IDUs. In this case, all modules of ODU display that the unit is in non-commissioning status.

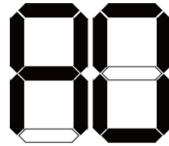

LED3

Step 6: Switch the commissioning software to the commissioning control interface.

Click "Debug" to switch to the engineering commissioning interface. The unit will automatically operate the commissioning modules listed in this interface from top to bottom and from left to right. Note: The commissioning function only applies to the single-system network.

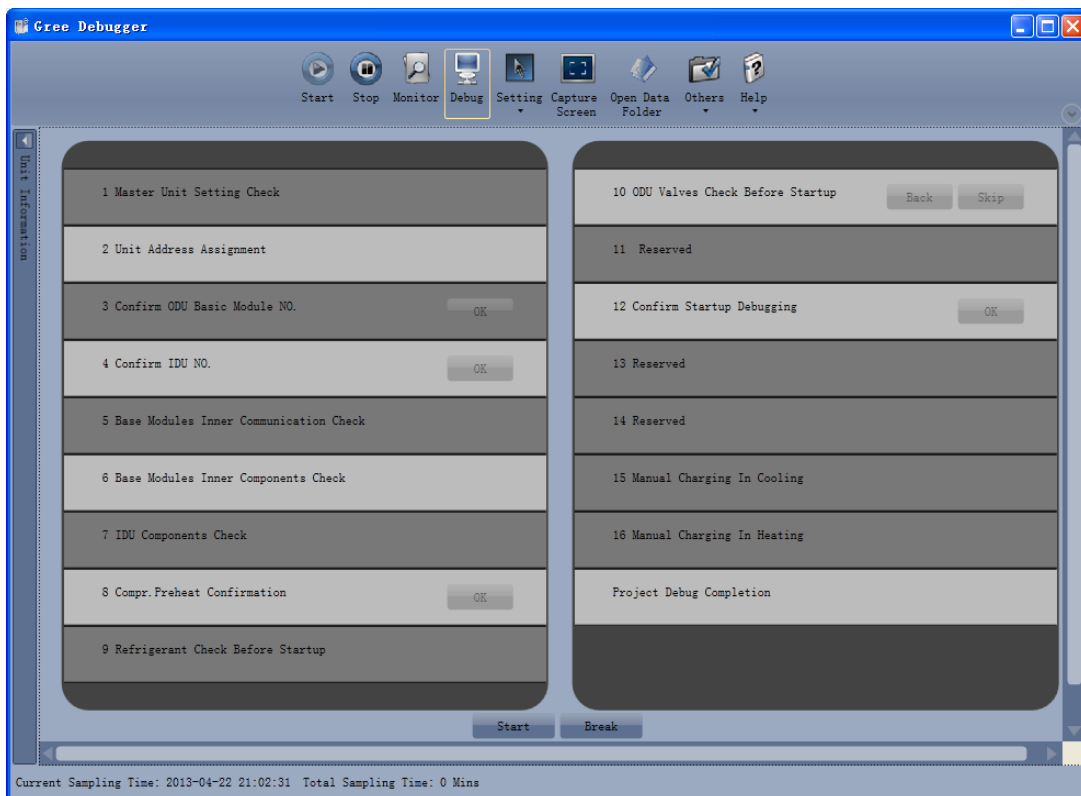

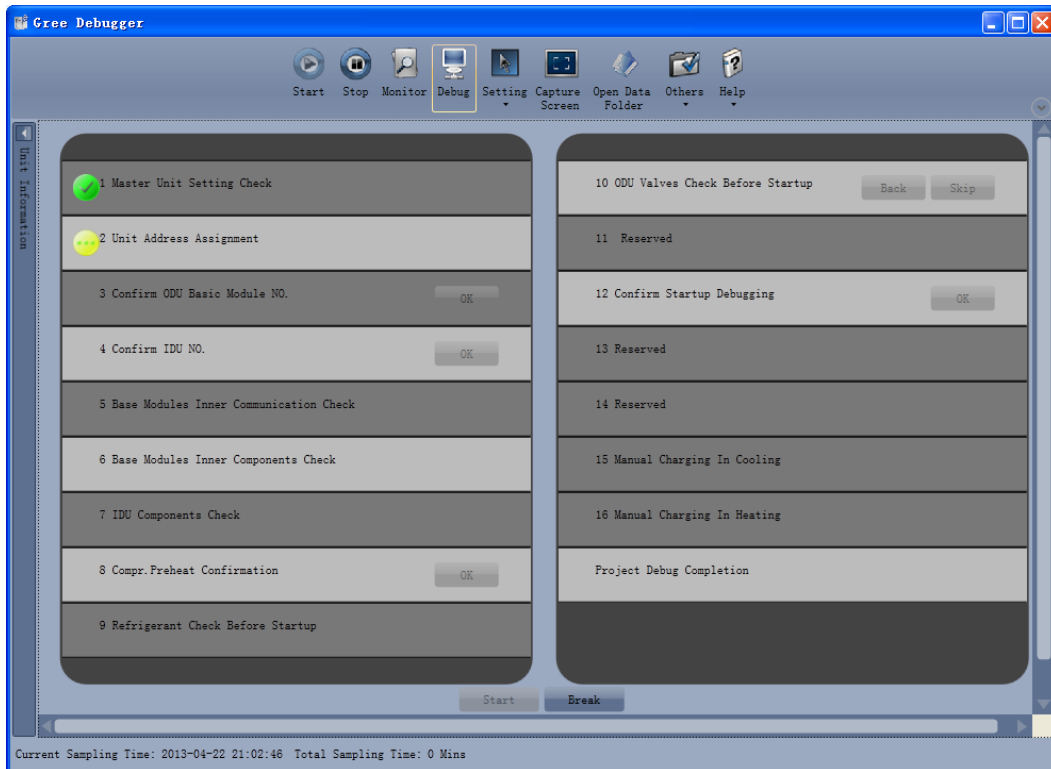

Click "Start" to enter the commissioning function and the software automatically performs commissioning. "🟡" indicates that commissioning is being performed on the phase and "🟢" indicates that commissioning is passed on the phase.

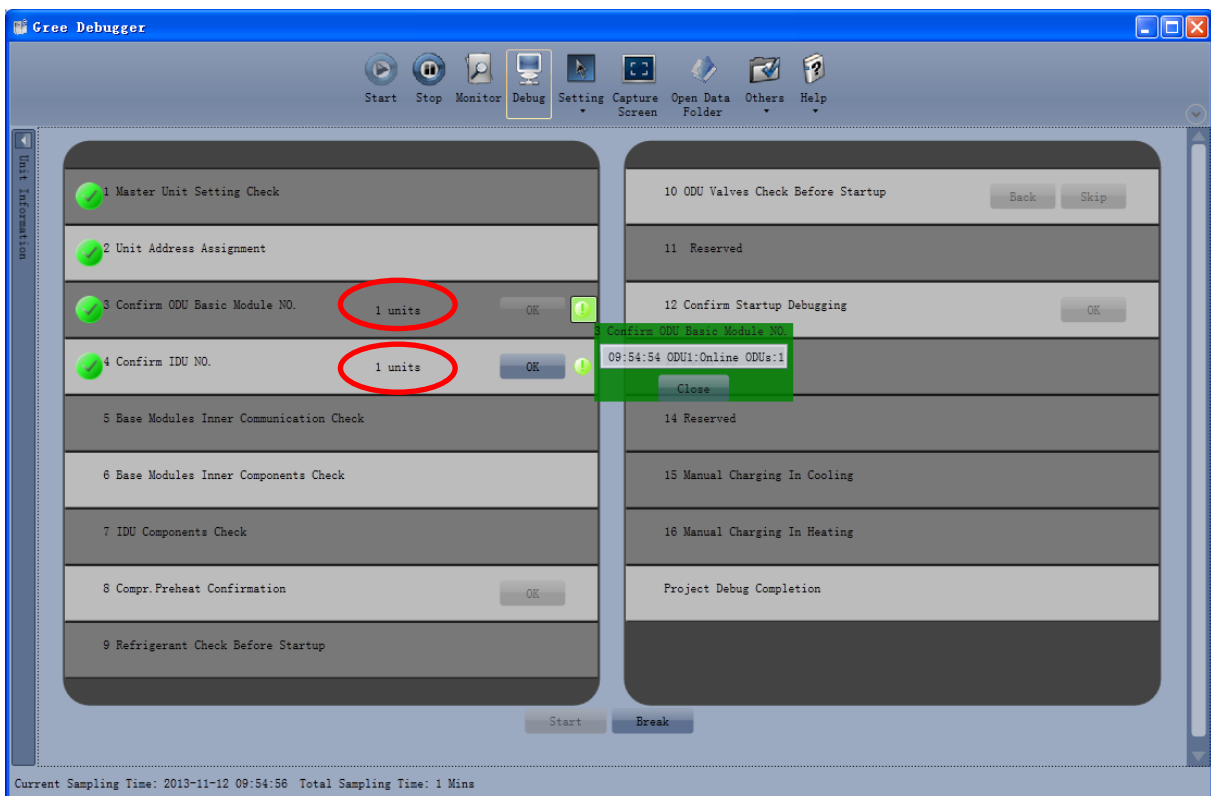

For the phase with "OK" displayed, a manual confirmation is required for entering the next commissioning step. Click "↓" to display relevant information detected on this phase, which provides references for selection. Click "Close" to close the information (the number of commissioning units is displayed in "3 Confirm ODU Basic Module NO." and "4 Confirm IDU NO."; the preheating period is displayed in "8 Compressor. Preheat Confirmation").

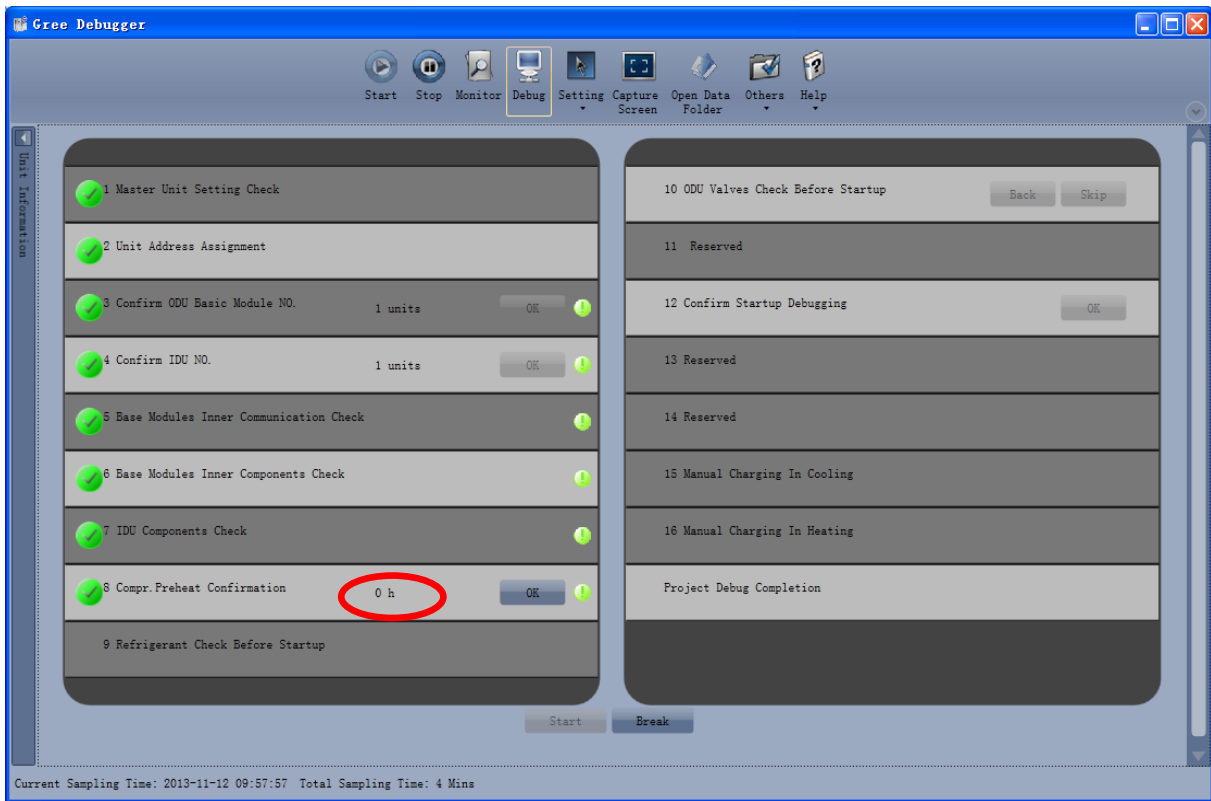



"" indicates that commissioning is not passed on the phase and troubleshooting is required (after troubleshooting, the unit automatically enters the next step if no "OK" exists or click "OK" to enter the next step). Click "" to display relevant information detected on this phase, which provides references for troubleshooting. Click "Close" to close the information.

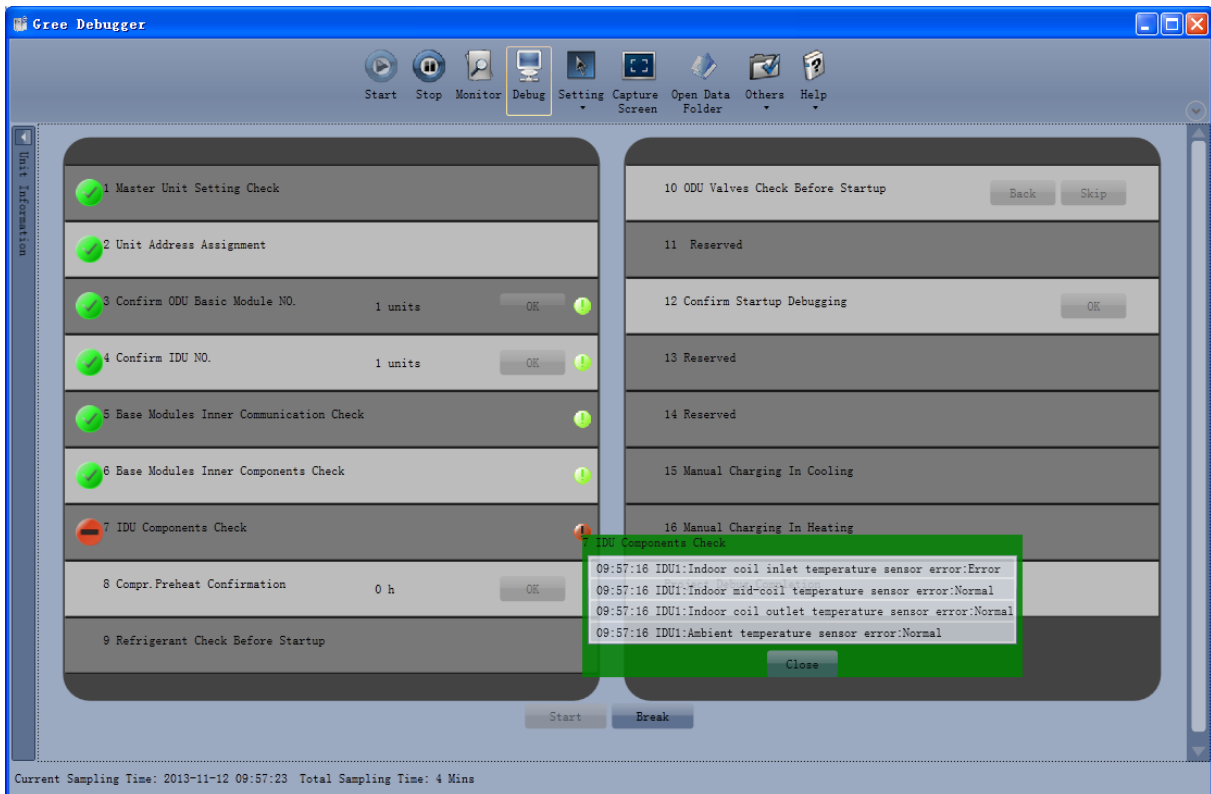

During commissioning, click "Stop" to stop commissioning and then click "Start" to continue commissioning till commissioning ends. "Back" and "Skip" are provided in "10 ODU Valves Check Before

Startup". When an exception occurs in step 10, click "Back" to return to step 9 and then click "OK" in step 9 to perform commissioning again for step 10. If a U6 fault (valve exception) occurs in step 10, users can click "Skip" to skip the fault. For other faults, "Skip" is unavailable.

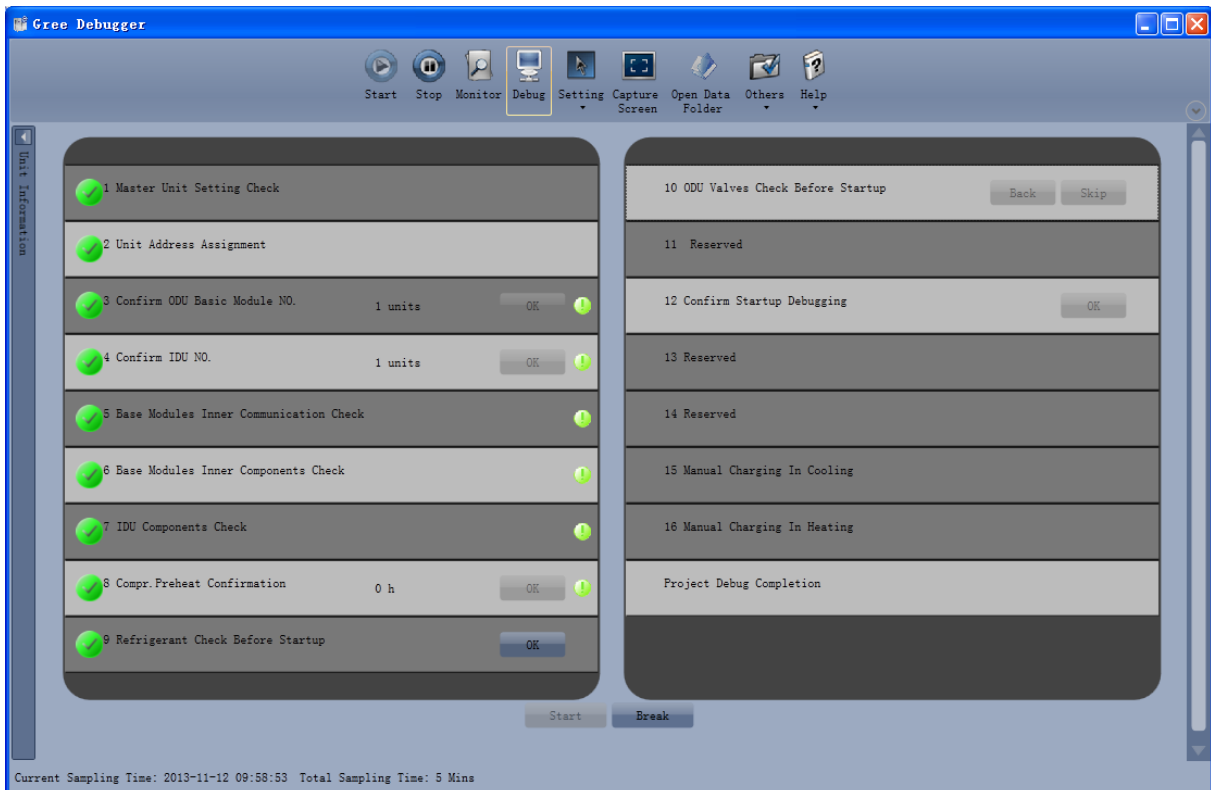
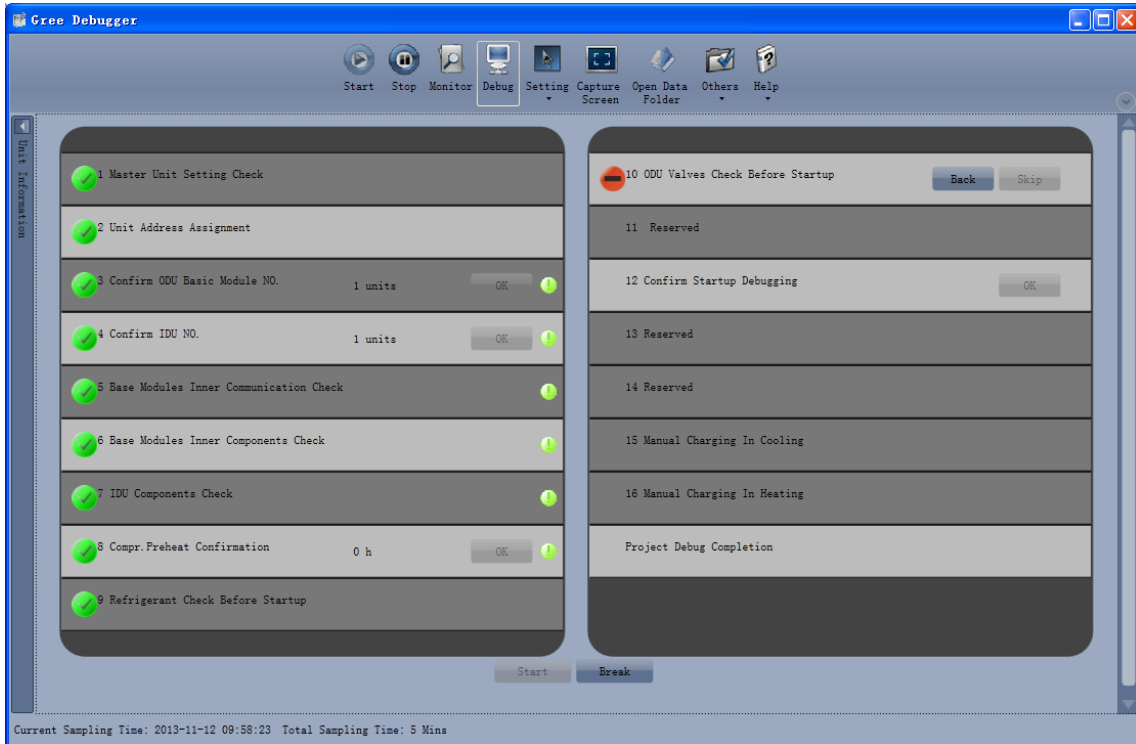

Commissioning steps 11, 13, and 14 are reserved. Steps 13, 14, 15, and 16 are parallel steps (one of the four steps will be selected according to the actual unit).

At last, engineering commissioning is completed when "  " is displayed on "Project Debug Completion".

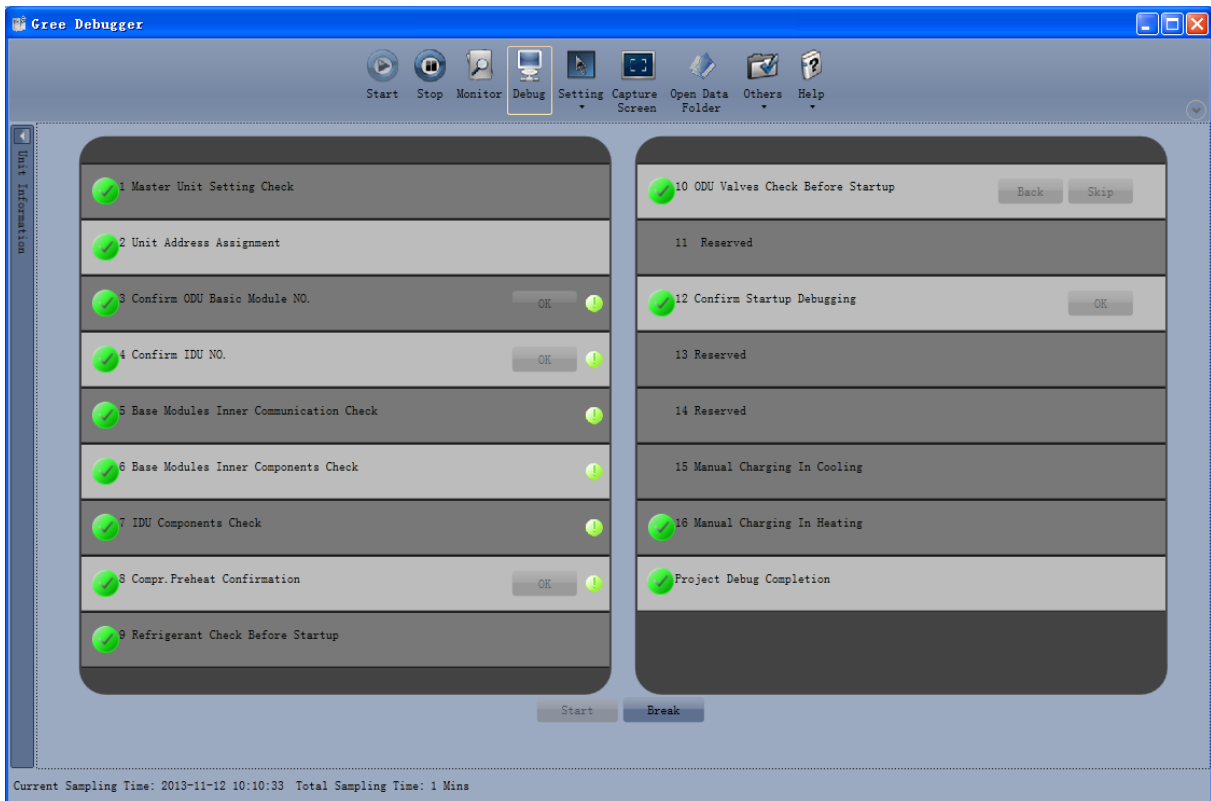

Note: During commissioning, users must listen to the operating sound of outdoor and indoor fans and compressors to check for exceptions.

(3) Commissioning Through the Portable Commissioning Tool

Step 1: Connect the Portable Commissioning Tool. Please refer to the operation manual of Portable Commissioning Tool for the connection method.

Step 2: Setting DIP of ODU address. You must set this DIP in main control ODU. The setting code (SA8) of main control unit shall be set to “00”. Otherwise, it is invalid.

Step 3: On the home page, press Unit Debug to enter into the page of engineering debugging.

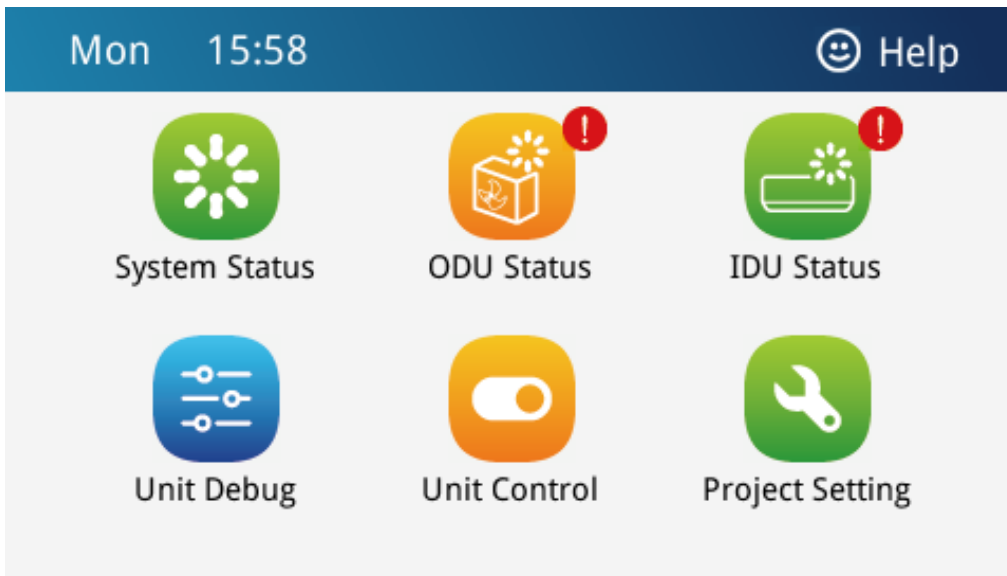

Step 4: On the engineering debugging page, click “Startup” button to start engineering debugging; press “Stoppage”) button to pause the engineering debugging;



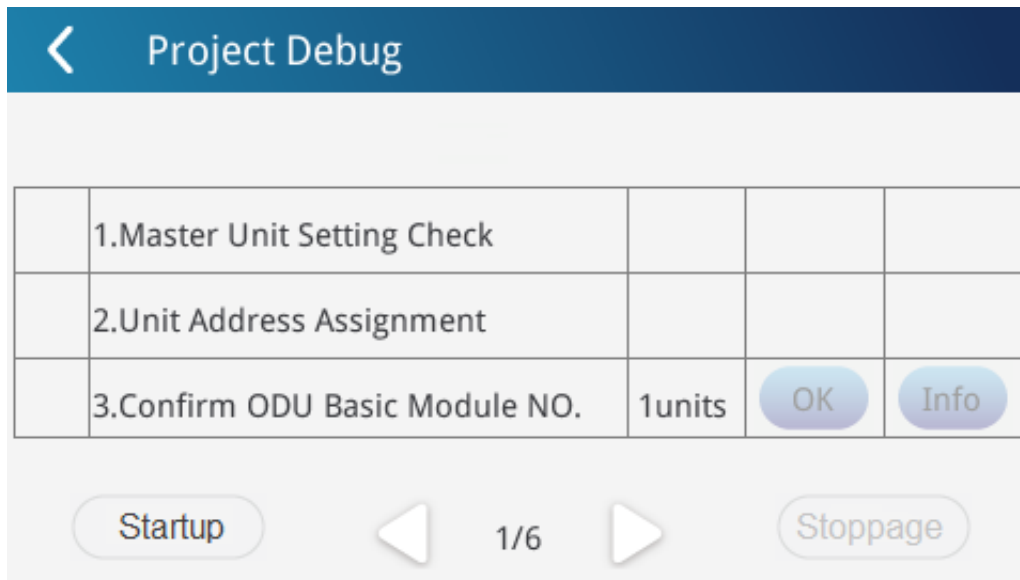

Step 5: Once it entered the engineering debugging, Portable Commissioning Tool will display current progress of engineering debugging (step#). As for step 3, 4, 8 and 12, it needs to click “OK” button to enter into the next step debugging. “Skip” can be selected for step 10. Detailed information check is available for step 3, 4, 5, 6 and 7.

Step 6: Once engineering debugging is finished, the outdoor unit displays 01 AC or AH OF (or error code when there’s malfunction; on is displayed when the unit is displayed)

**Warning:** After finishing operating this product, the wiring of air conditioner must be resumed. Otherwise, it may affect the actual operation of user!

#### 2.3.3.4 Operations after Commissioning

Sort and save data. Make detailed records of exceptions and troubleshooting methods during commissioning for later maintenance and query. At last, make a commissioning report and hand it over to users.

#### 2.3.3.5 Precautions to Let Users Know after Commissioning

- (1) Let users know where the master IDU is located and stick a label to the master IDU. Tell users that modes of other IDUs are limited by the mode of master IDU.
- (2) An ODU that has been in power-off status for more than 24 hours should be preheated for more than eight hours before startup to prevent damaging compressors.

## 2.4 REFERENCES FOR PROPER UNIT OPERATION PARAMETERS

SN	Commissioning Item	Parameter Name	Unit	Reference Value	
1	System parameter	Outdoor environment temperature	°C/ °F	—	
2		Discharge pipe temperature of compressor	°C/ °F	<ul style="list-style-type: none"> <li>When the system compressor is running, the normal discharge pipe or top temperature for cooling is 70-95°C(167-203°F), which is more than 10°C(18°F) higher than the saturation temperature corresponding to the system high-pressure. The normal temperature for heating is 65-80°C(149-176°F), which is more than 10°C(18°F) higher than the saturation temperature corresponding to the system high-pressure.</li> </ul>	
3		Defrosting temperature	°C/ °F	<ul style="list-style-type: none"> <li>When the system runs for cooling, the defrosting temperature is 5-11°C(41-52°F) lower than the system high-pressure value.</li> <li>When the system runs for heating, the defrosting temperature is 2°C(3.6°F) higher or lower than the system low-pressure value.</li> </ul>	
4		System high-pressure	°C/ °F	<ul style="list-style-type: none"> <li>The normal system high-pressure value is 20-55°C(68-131°F). With the change of environment temperature and system operation capacity, the system high-pressure value is 10-40°C(50-104°F) higher than the environment temperature. The higher the environment temperature, the less the temperature difference.</li> <li>When the system runs for cooling with the environment temperature being 25-35°C(77-95°F), the system high-pressure value is 44-53°C(111-127°F).</li> <li>When the system runs for heating with the environment temperature being -5 - 10°C(23-50°F), the system low-pressure value is 40-52°C(104-125°F).</li> </ul>	
5		System low-pressure	°C/ °F	<ul style="list-style-type: none"> <li>When the system runs for cooling with the environment temperature being 25-35°C(77-95°F), the system low-pressure value is 0-8°C(32-46°F).</li> <li>When the system runs for heating with the environment temperature being -5 - 10°C(23-50°F), the system low-pressure value is -15 - 5°C(5-41°F).</li> </ul>	
6		Opening degree of heating electronic expansion valves	PLS	<ul style="list-style-type: none"> <li>During the cooling operation, the heating electronic expansion valves always remain at 480 PLS.</li> <li>During the heating operation, the adjustable electronic expansion valves change between 120 and 480 PLS.</li> </ul>	
7		Current of inverter compressor	A	<ul style="list-style-type: none"> <li>According to different operation frequencies and loads, the current of inverter compressor 1 changes between 7 and 25 A. The current of inverter compressor 2 changes between 7 and 20 A.</li> </ul>	
8		IPM module temperature of inverter compressor	°C/ °F	<ul style="list-style-type: none"> <li>When the environment temperature is lower than 35°C, the temperature of the IPM module is lower than 80°C. The highest temperature is not higher than 95°C.</li> </ul>	
9		Indoor unit parameter	Environment temperature of IDU	°C/ °F	—
10			Inlet-tube temperature of indoor heat exchanger	°C/ °F	<ul style="list-style-type: none"> <li>As the environment temperature is different, the inlet-tube temperature is 1-7°C(1.8-12.6°F) lower than the outlet-tube temperature of the same IDU in cooling mode.</li> </ul>
11			Outlet-tube temperature of indoor heat exchanger	°C/ °F	<ul style="list-style-type: none"> <li>The inlet-tube temperature is 10-20°C(18-36°F) lower than the outlet-tube temperature of the same IDU in heating mode.</li> </ul>
12			Opening degree of indoor electronic expansion valves	PLS	The opening degree automatically changes between 0 and 2000 PLS or between 0 and 480 PLS.
13	Communication parameter	Communication data	—	<ul style="list-style-type: none"> <li>The commissioning software shows that the number of IDUs/ODUs is consistent with the actual engineering quantity, without communication failure.</li> </ul>	
14	Drainage system	—	—	<ul style="list-style-type: none"> <li>The drainage effect of IDU is smooth and thorough, and no adverse-slope water storage exists in condensing drainage pipes. The ODU can implement drainage completely from the drainage pipe, without drops from the unit foundation.</li> </ul>	
15	Other	—	—	<ul style="list-style-type: none"> <li>No exceptional sound occurs on compressors and indoor/outdoor fans. No fault occurs on the unit operation.</li> </ul>	

# CHAPTER 4 MAINTENANCE

## 1 SYSTEM FAILURE CODE TABLE

Indoor:

Error Code	Content	Error Code	Content
L0	Malfunction of IDU	d2	Malfunction of lower water temperature sensor of water tank
L1	Protection of indoor fan	d3	Malfunction of ambient temperature sensor
L2	Auxiliary heating protection	d4	Malfunction of entry-tube temperature sensor
L3	Water-full protection	d6	Malfunction of exit-tube temperature sensor
L4	Abnormal power supply for wired controller	d7	Malfunction of humidity sensor
L5	Freeze prevention protection	d8	Malfunction of water temperature sensor
L7	No main IDU	d9	Malfunction of jumper cap
L8	Power supply is insufficient	dA	Web address of IDU is abnormal
L9	For single control over multiple units, number of IDU is inconsistent	dH	PCB of wired controller is abnormal
LA	For single control over multiple units, IDU series is inconsistent	dC	Setting capacity of DIP switch code is abnormal
LH	Alarm due to bad air quality	dL	Malfunction of air outlet temperature sensor
LC	IDU is not matching with outdoor unit	dE	Malfunction of indoor CO <sub>2</sub> sensor
LL	Malfunction of water flow switch	dF	Malfunction of upper water temperature sensor of water tank
LE	Rotation speed of EC DC water pump is abnormal	dJ	Malfunction of backwater temperature sensor
LF	Malfunction of shunt valve setting	dP	Malfunction of inlet tube temperature sensor of generator
LJ	Setting of functional DIP switch code is wrong	dU	Malfunction of drainage pipe temperature sensor of generator
LP	Zero-crossing malfunction of PG motor	db	Debugging status
LU	Indoor unit's branch is not inconsistent for one-to-more unit of heat recovery system	dd	Malfunction of solar power temperature sensor
d1	Indoor PCB is poor	dn	Malfunction of swing parts

## Outdoor:

Error Code	Content	Error Code	Content
E0	Malfunction of ODU	FH	PCB of wired controller is abnormal
E1	High-pressure protection	FC	Current sensor of compressor 2 is abnormal
E2	Discharge low-temperature protection	FL	Current sensor of compressor 3 is abnormal
E3	Low-pressure protection	FE	Current sensor of compressor 4 is abnormal
E4	High discharge temperature protection of compressor	FF	Current sensor of compressor 5 is abnormal
E7	No main IDU	FJ	Current sensor of compressor 6 is abnormal
E8	Power supply is insufficient	FP	Malfunction of DC motor
E9	For single control over multiple units, number of IDU is inconsistent	FU	Malfunction of casing top temperature sensor of compressor 1
EA	For single control over multiple units, IDU series is inconsistent	Fb	Malfunction of casing top temperature sensor of compressor 2
EH	Alarm due to bad air quality	Fd	Malfunction of exit tube temperature sensor of mode exchanger
J0	Protection for other modules	Fn	Malfunction of inlet tube temperature sensor of mode exchanger
J1	Over-current protection of compressor 1	b1	Malfunction of outdoor ambient temperature sensor
J2	Over-current protection of compressor 2	b2	Malfunction of defrosting temperature sensor 1
J3	Over-current protection of compressor 3	b3	Malfunction of defrosting temperature sensor 2
J4	Over-current protection of compressor 4	b4	Malfunction of liquid temperature sensor of sub-cooler
J5	Over-current protection of compressor 5	b5	Malfunction of gas temperature sensor of sub-cooler
J6	Over-current protection for compressor 6	b6	Malfunction of inlet tube temperature sensor of vapor liquid separator
J7	Gas-mixing protection of 4-way valve	b7	Malfunction of exit tube temperature sensor of vapor liquid separator
J8	High pressure ratio protection of system	b8	Malfunction of outdoor humidity sensor
J9	Low pressure ratio protection of system	b9	Malfunction of gas temperature sensor of heat exchanger
JA	Protection because of abnormal pressure	bA	Malfunction of oil-return temperature sensor 1
JC	Water flow switch protection	bH	Clock of system is abnormal
JL	Protection because high pressure is too low	bC	Protection because the temperature sensor at the top of compressor 1 is loose
JE	Oil-return pipe is blocked	bL	Protection because the temperature sensor at the top of compressor 2 is loose
JF	Oil-return pipe is leaking	bE	Malfunction of inlet tube temperature sensor of condenser
P0	malfunction of driving board of compressor	bF	Malfunction of outlet tube temperature sensor of condenser
P1	Driving board of compressor operates abnormally	bJ	High-pressure sensor and low-pressure sensor are connected reversely
P2	Voltage protection of driving board power of compressor	bP	Malfunction of temperature sensor of oil-return 2
P3	Reset protection of driving module of	bU	Malfunction of temperature sensor of oil

Error Code	Content	Error Code	Content
	compressor		return 3
P4	Drive PFC protection of compressor	bb	Malfunction of temperature sensor of oil return 4
P5	Over-current protection of inverter compressor	H0	Malfunction of driving board of fan
P6	Drive IPM module protection of compressor	H1	Driving board of fan operates abnormally
P7	Malfunction of drive temperature sensor of compressor	H2	Voltage protection of driving board power of fan
P8	Drive IPM high temperature protection of compressor	H3	Reset protection of driving module of fan
P9	Desynchronizing protection of inverter compressor	H4	Drive PFC protection of fan
PA	Malfunction of drive storage chip of compressor	H5	Over-current protection of inverter fan
PH	High-voltage protection of compressor's drive DC bus bar	H6	Drive IPM module protection of fan
PC	Malfunction of current detection circuit drive of compressor	H7	Malfunction of drive temperature sensor of fan
PL	Low voltage protection for DC bus bar of drive of compressor	H8	Drive IPM high temperature protection of fan
PE	Phase-lacking of inverter compressor	H9	Desynchronizing protection of inverter fan
PF	Malfunction of charging loop of driven of compressor	HA	Malfunction of drive storage chip of inverter outdoor fan
PJ	Failure startup of inverter compressor	HH	High-voltage protection of fan's drive DC bus bar
PP	AC current protection of inverter compressor	HC	Malfunction of current detection circuit of fan drive
PU	AC input voltage of drive of inverter compressor	HL	Low voltage protection of bus bar of fan drive
F0	Main board of ODU is poor	HE	Phase-lacking of inverter fan
F1	Malfunction of high-pressure sensor	HF	Malfunction of charging loop of fan drive
F3	Malfunction of low-pressure sensor	HJ	Failure startup of inverter fan
F5	Malfunction of discharge temperature sensor of compressor 1	HP	AC current protection of inverter fan
F6	Malfunction of exit-tube temperature sensor	HU	AC input voltage of drive of inverter fan
F7	Malfunction of humidity sensor	HJ	Failure startup of inverter fan
F8	Malfunction of water temperature sensor	HP	AC current protection of inverter fan
F9	Malfunction of jumper cap	HU	AC input voltage of drive of inverter fan
FA	Web address of IDU is abnormal		

## Debugging:

Error Code	Content	Error Code	Content
U0	Preheat time of compressor is insufficient	C6	Alarm because ODU quantity is inconsistent
U2	Wrong setting of ODU's capacity code/jumper cap	C7	Abnormal communication of converter
U3	Power supply phase sequence protection	C8	Emergency status of compressor
U4	Refrigerant-lacking protection	C9	Emergency status of fan
U5	Wrong address for driving board of compressor	CA	Emergency status of module
U6	Alarm because valve is abnormal	CH	Rated capacity is too high
U8	Malfunction of pipeline for IDU	CC	No main unit
U9	Malfunction of pipeline for ODU	CL	The matching ratio of rated capacity for IDU and ODU is too low
UC	Setting of main IDU is succeeded	CE	Communication malfunction between mode exchanger and IDU
UL	Emergency operation DIP switch code of compressor is wrong	CF	Malfunction of multiple main control units
UE	Charging of refrigerant is invalid	CJ	Address DIP switch code of system is shocking
UF	Identification malfunction of IDU of mode exchanger	CP	Malfunction of multiple wired controller
C0	Communication malfunction between IDU, ODU and IDU's wired controller	CU	Communication malfunction between IDU and the receiving lamp
C2	Communication malfunction between main control and inverter compressor driver	Cb	Overflow distribution of IP address
C3	Communication malfunction between main control and inverter fan driver	Cd	Communication malfunction between mode exchanger and ODU
C4	Malfunction of lack of IDU	Cn	Malfunction of network for IDU and ODU of mode exchanger
C5	Alarm because project code of IDU is inconsistent	Cy	Communication malfunction of mode exchanger

## Status:

Error Code	Content	Error Code	Content
A0	Unit waiting for debugging	Ay	Shielding status
A2	Refrigerant recovery operation of after-sales	n0	SE operation setting of system
A3	Defrosting	n3	Compulsory defrosting
A4	Oil-return	n4	Limit setting for max. capacity/output capacity
A6	Heat pump function setting	n5	Compulsory excursion of engineering code of IDU
A7	Quiet mode setting	n6	Inquiry of malfunction
A8	Vacuum pump mode	n7	Inquiry of parameters
AH	Heating	n8	Inquiry of project code of IDU
AC	Cooling	n9	Check quantity of IDU on line
AL	Charge refrigerant automatically	nA	Heat pump unit
AE	Charge refrigerant manually	nH	Heating only unit
AF	Fan	nC	Cooling only unit
AJ	Cleaning reminding of filter	nE	Negative code
AP	Debugging confirmation when starting up the unit	nF	Fan model
AU	Long-distance emergency stop	nJ	High temperature prevention when heating
Ab	Emergency stop of operation	nU	Eliminate the long-distance shielding command of IDU
Ad	Limit operation	nb	Bar code inquiry
An	Child lock status	nn	Length modification of connection pipe of ODU

**NOTE:** Previous faults in the system can be queried on the main board of the ODU and commissioning software. See n6 Fault Enquiry of the ODU or enquiry function of the commissioning software for the method.

# 2 EXCEPTION AND TROUBLESHOOTING

## 2.1 How to locate a faulty IDU promptly

Use the IDU project number enquiry and faulty IDU locating function to locate a faulty IDU or wired controller's corresponding IDU as follows when multiple IDUs are running in one place:

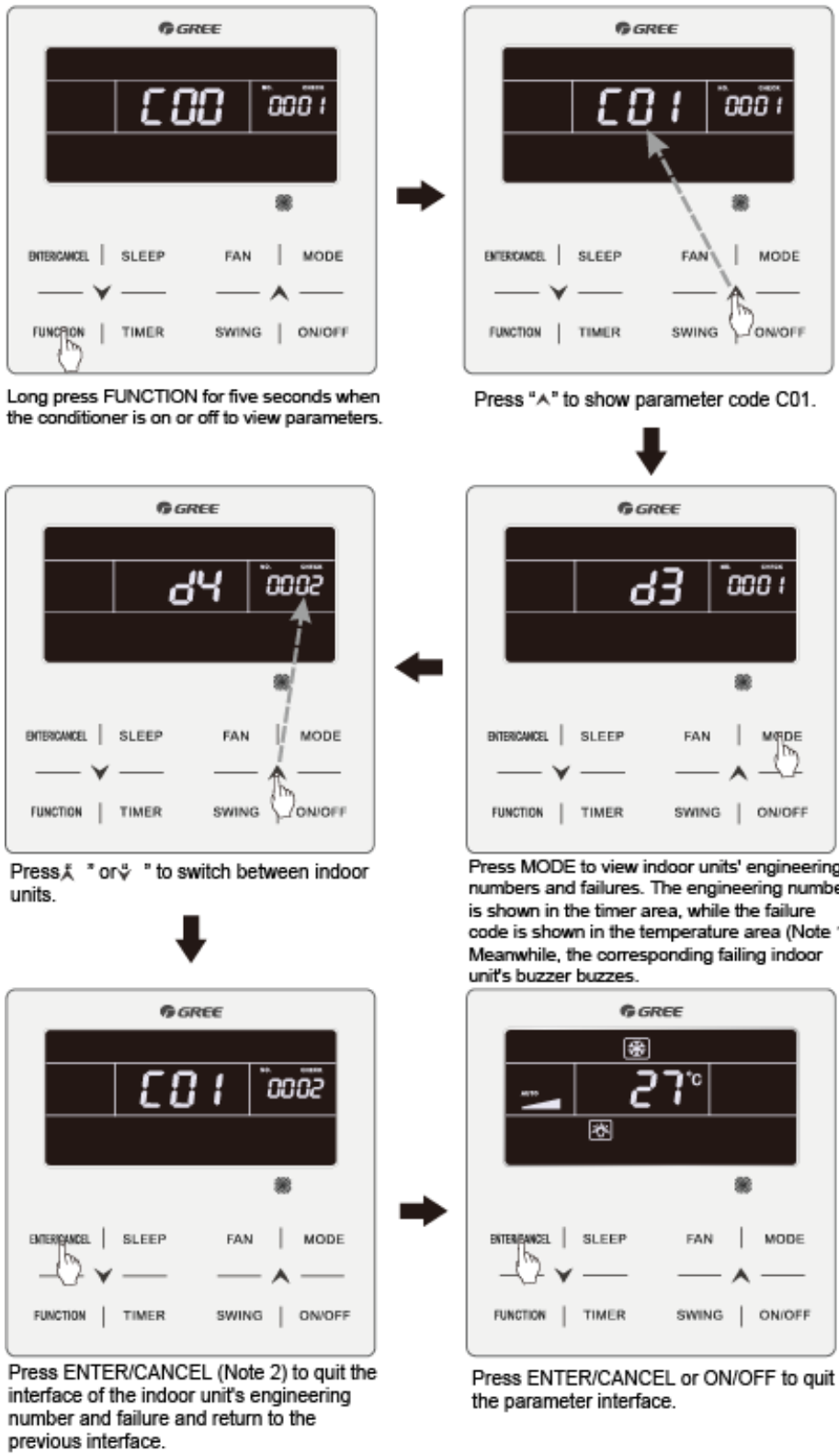

C01 Indoor project number and fault enquiry



**NOTE:**

- ① If the enquired IDU is normal, no fault code will be displayed in the temperature area; if the unit indoor has multiple faults, fault codes will be displayed in the temperature area at an interval of 3 seconds.
- ② Press the “ON/OFF” button on the interface of IDU project number and fault enquiry to exist the parameter enquiry interface.

**2.2 Form analyzing****2.2.1 Control**

Fault code	Fault	Possible reasons	Solution
F0	Faults in the ODU's main board (such as memory and address chip exceptions)	<ol style="list-style-type: none"> <li>1. The clock chip on the main board is damaged.</li> <li>2. The memory chip on the main board is damaged.</li> <li>3. The address chip on the main board is damaged.</li> </ol>	<ol style="list-style-type: none"> <li>1. Replace the small CPU board.</li> <li>2. Replace the control board.</li> <li>3. Replace the control board.</li> </ol>
FC	Faults in the constant frequency compressor's current sensor	<ol style="list-style-type: none"> <li>1. The constant-frequency compressor is not started.</li> <li>2. The current detection board is faulty.</li> <li>3. The main board's detection circuit is faulty.</li> </ol>	<ol style="list-style-type: none"> <li>1. If the compressor is not started, check if the AC contact is closed. If not, replace the AC contact. If the connection is loose, reconnect it;</li> <li>2. Replace the current detection board.</li> <li>3. Replace the main board.</li> </ol>
U2	Wrong outdoor capacity code setting	<ol style="list-style-type: none"> <li>1. The capacity code is wrong.</li> <li>2. The dial component is faulty.</li> </ol>	<ol style="list-style-type: none"> <li>1. Modify the capacity code setting.</li> <li>2. Replace the main board.</li> </ol>
U3	Power phase sequence protection	<ol style="list-style-type: none"> <li>1. The three-phase power cable is not connected correctly.</li> <li>2. The main board's detection circuit is faulty.</li> </ol>	<ol style="list-style-type: none"> <li>1. Check connection of the power cable.</li> <li>2. Replace the control board.</li> </ol>
UL	Wrong emergency operation dial code	<ol style="list-style-type: none"> <li>1. The dial setting is wrong.</li> <li>2. The dial component is faulty.</li> </ol>	<ol style="list-style-type: none"> <li>1. Modify the dial setting.</li> <li>2. Replace the main board.</li> </ol>
C0	Communication failure between indoor and ODUs and IDU's communicator	<ol style="list-style-type: none"> <li>1. The communication cable is not connected.</li> <li>2. The communicator is disconnected.</li> <li>3. The communication cable is poorly connected.</li> <li>4. The communicator controller is faulty.</li> </ol>	<p>If C0 is not displayed on the control board of the ODU, check the network between the IDU and communicator. If C0 is displayed, check the network between the IDUs and ODUs and between the IDU and communicator as follows:</p> <ol style="list-style-type: none"> <li>1) Check if the cables connecting the control board of the ODU and the IDU and connecting the IDU and communicator are loose. If yes, reconnect them;</li> <li>2) Check if the cables connecting the control board and IDU and connecting the IDU and communicator are broken. If yes, replace the cables;</li> <li>3) Check the contact of the communication cables;</li> <li>4) Replace the control board. If the fault is solved, the control board is faulty. Replace the IDU. If the fault is solved, the IDU is faulty.</li> </ol>

Fault code	Fault	Possible reasons	Solution
C2	Communication failure between main control board and inverter compressor drive	<ol style="list-style-type: none"> <li>1. The communication cable is not connected.</li> <li>2. The communicator is disconnected.</li> <li>3. The communication cable is poorly connected.</li> <li>4. The communicator is faulty.</li> </ol>	<ol style="list-style-type: none"> <li>1) Check if the cable connecting the control board and the compressor's drive board is loose. If yes, reconnect it;</li> <li>2) Check if the cable connecting the control board and compressor's drive board is broken. If yes, replace the cable;</li> <li>3) Check the contact of the communication cable connecting the control board and compressor's drive board;</li> <li>4) Replace the control board. If the fault is solved, the control board is faulty. Replace the compressor's drive board. If the fault is solved, the compressor's drive board is faulty.</li> </ol>
C3	Communication failure between main control board and variable frequency fan drive	<ol style="list-style-type: none"> <li>1. The communication cable is not connected.</li> <li>2. The communicator is disconnected.</li> <li>3. The communication cable is poorly connected.</li> <li>4. The communicator is faulty.</li> </ol>	<ol style="list-style-type: none"> <li>1) Check if the cable connecting the fan's drive board and the compressor's drive board is loose. If yes, reconnect it;</li> <li>2) Check if the cable connecting the fan's drive board and compressor's drive board is broken. If yes, replace the cable;</li> <li>3) Check the contact of the communication cable connecting the fan's drive board and compressor's drive board;</li> <li>4) Replace the control board. If the fault is solved, the control board is faulty. Replace the fan's drive board. If the fault is solved, the fan's drive board is faulty.</li> </ol>
C4	Malfunction of lack of indoor unit	<ol style="list-style-type: none"> <li>1. Some indoor units in the system are not power-connected.</li> <li>2. Communication wires of some indoor units in the system are disconnected or have loose contact.</li> <li>3. Controllers of some indoor units in the system are abnormal.</li> </ol>	<ol style="list-style-type: none"> <li>1. Check the number of online indoor units through outdoor unit and compare it with the number of indoor units that are actually installed. Confirm the number of missing indoor units.</li> <li>2. Check whether all the indoor units are power-connected. If some are not, connect them to power. If power connection is fine, check further whether there is any indoor unit that fails to display on wired controller or receiver board. If such indoor unit exists, it means its main board is abnormal and needs to be replaced. If everything said above is confirmed OK, continue to check according to step 3.</li> <li>3. The missing indoor units will display error "C0" on wired controller or receiver board. Check the communication wire of the missing indoor unit whether it is disconnected or has loose contact. If yes, connect the communication wire tightly. If communication wire is OK, check whether it is connected reversely. Power on the indoor unit again and see if error "C0" occurs. If "C0" is displayed, it means main board is abnormal and needs to be replaced.</li> </ol>
C5	Indoor unit project number conflict warning	<ol style="list-style-type: none"> <li>1. Project numbers conflict with each other.</li> </ol>	<ol style="list-style-type: none"> <li>1. Change conflicting project numbers and ensure that no IDU's project number is repeated.</li> </ol>
C6	Outdoor unit number inconsistency warning	<ol style="list-style-type: none"> <li>Communication cables between ODUs are loose.</li> <li>Communication cables between ODUs are broken.</li> <li>Communication cables between ODUs are poorly connected.</li> <li>4. The control board is faulty.</li> </ol>	<ol style="list-style-type: none"> <li>1. If the communication cable is loose, reconnect it;</li> <li>2. If the communication cable is broken, replace it;</li> <li>3. Check contact of the communication cable;</li> <li>4. Replace the control board.</li> </ol>

Fault code	Fault	Possible reasons	Solution
CC	No controlling unit	The SA8 dial switch of the ODU is not switched to 00. The SA8 dial switch of the ODU is faulty.	1. Switch the SA8 dial switch of an ODU to 00; 2. Replace the control board or switch an ODU's SA8 dial switch to 00.
CF	Multiple controlling units	SA8 dial switches of multiple ODUs are switched to 00. Dial switches of multiple ODUs are faulty.	1. Leave one SA8 dial switch unchanged, while switch all the other dial switches to 11; 2. Replace the control board.
L7	No master IDU	The master IDU is powered off. The communication of the master IDU fails. The main board of the master IDU is faulty. No master IDU is set in the system.	Check if the master IDU is powered on. If yes, replace the main board; Check the contact of the communication cable of the master IDU. If no communication failure (C0) is reported, replace the main board. Replace the IDU's main board and reset the master IDU. Set the master IDU.

**Note:** Solution of C5 fault when multiple cooling systems are controlled in a centralized way.

When multiple cooling systems are controlled in a centralized way, the C5 fault, i.e. project number conflict, may occur on different cooling systems. In such case, set project numbers of each system and solve the fault as follows:

1) Project number conflict:

When multiple systems are controlled in a centralized way, if two or more IDUs share the same project number, the engineer number conflict occurs. In that case, IDUs cannot be switched to varied modes or be turned on or off. The whole device cannot be started before the conflict is solved. The commissioning software will show the following page:

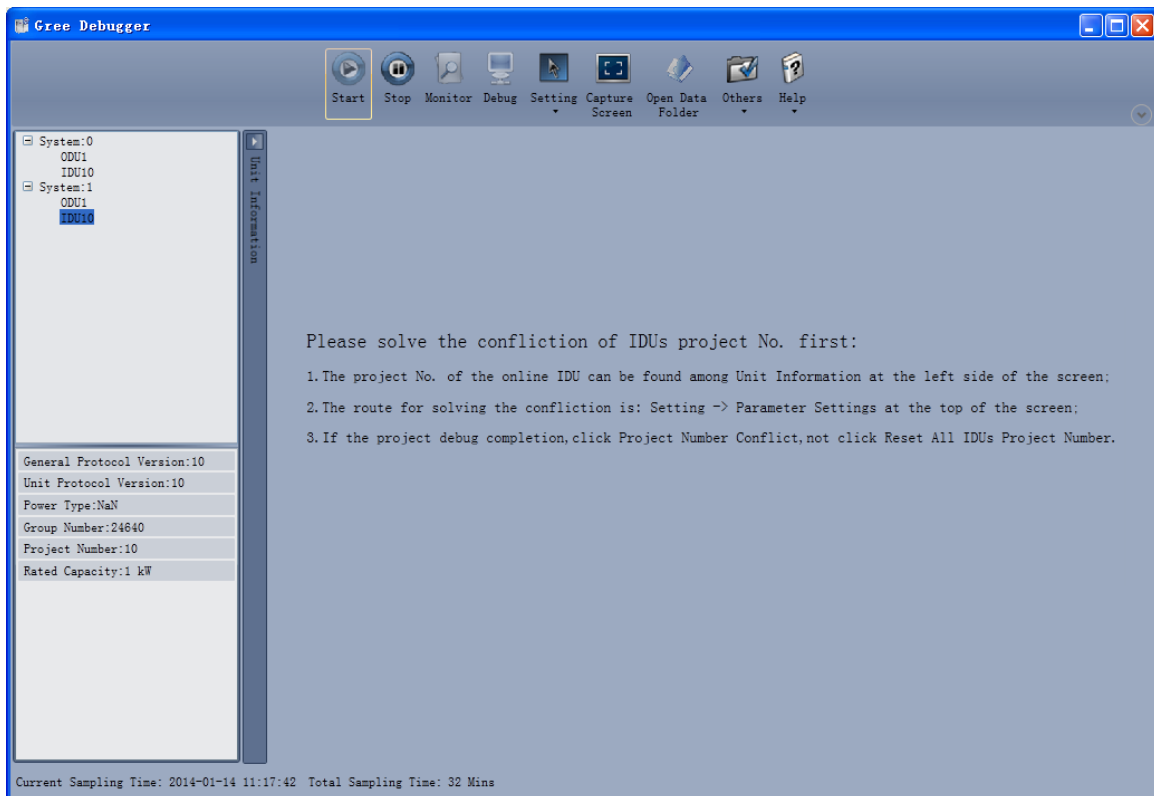

Figure 1

2) Solution of project number conflict:

① Manual setting on the commissioning software:

Use the commissioning software to set IDUs' project numbers separately in every system or reset projects numbers in multiple systems.

Choose Setting -> Parameter Settings, as shown in Figure 2:

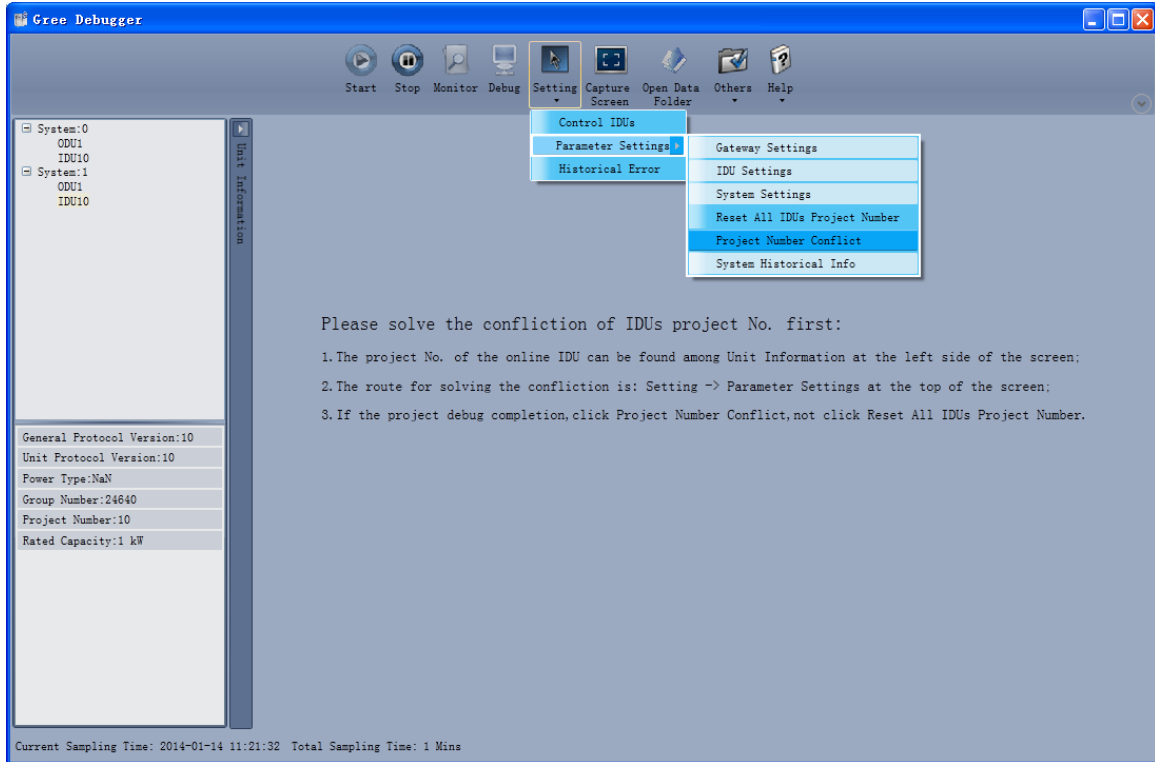

Figure 2

If project commissioning is finished and the IDU where the conflict occurs needs to be set separately. Click Project Number Conflict, as shown in Figure 3. The pop-up box comprises two parts: conflicting IDU box, showing the IDU's project number, system number and time; setting box, showing the IDU project number setting and setting button.

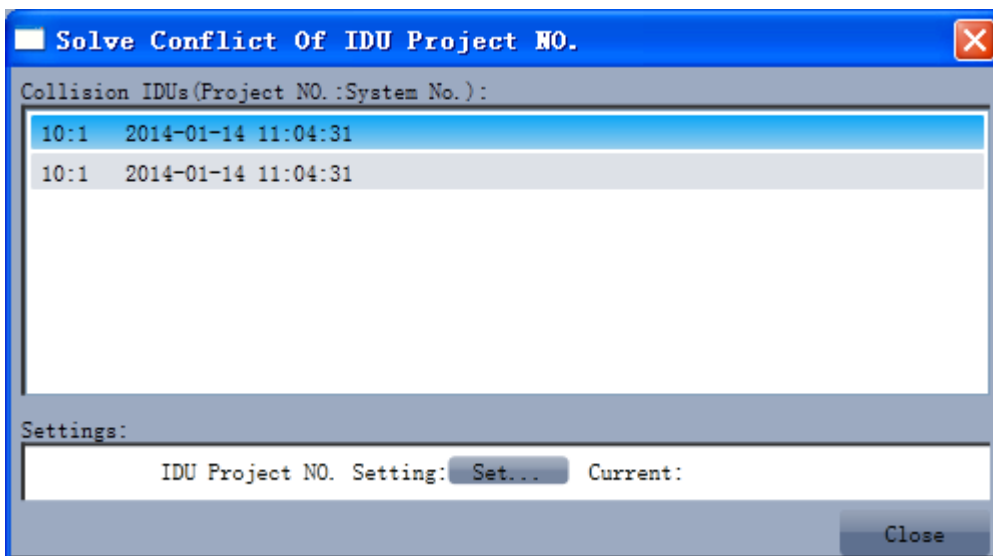

Figure 3

Choose one IDU in the conflicting IDU box shown in Figure 3 and click Set in the setting box. Choose a value in the pop-up box shown in Figure 4 and click Set.

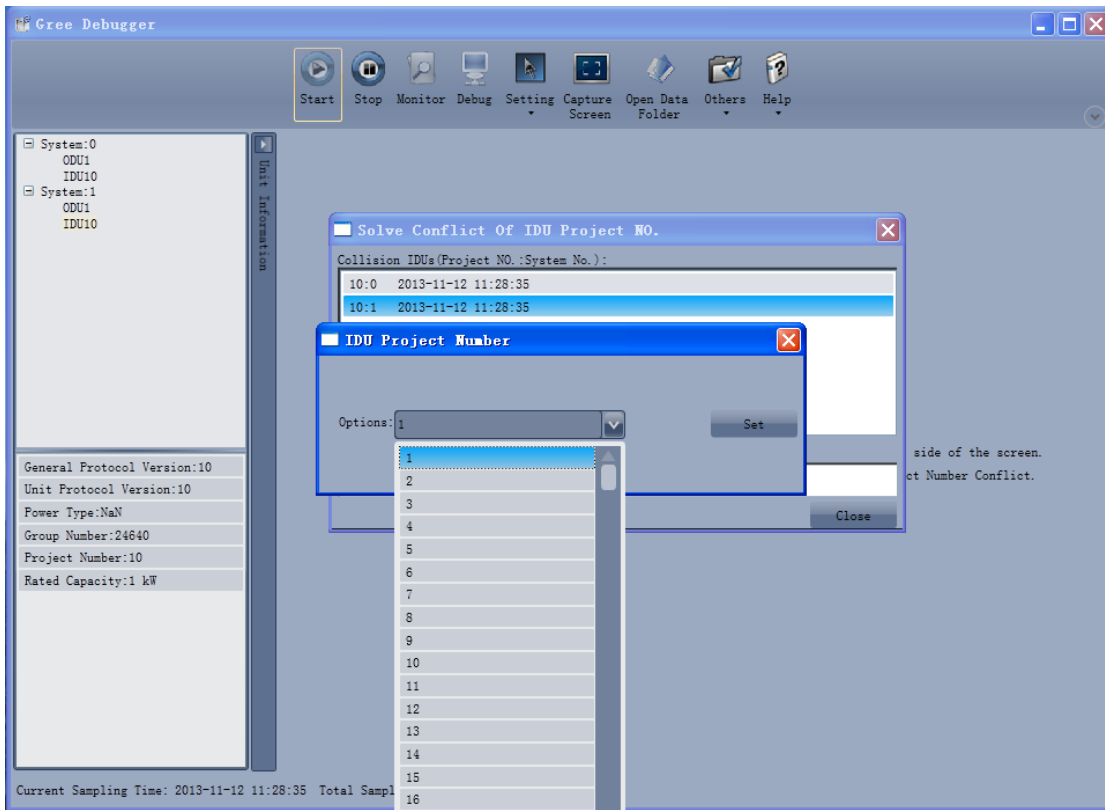

Figure 4

If the conflict is solved, the system will return to the normal status and IDUs can be operated, as shown in Figure 5:

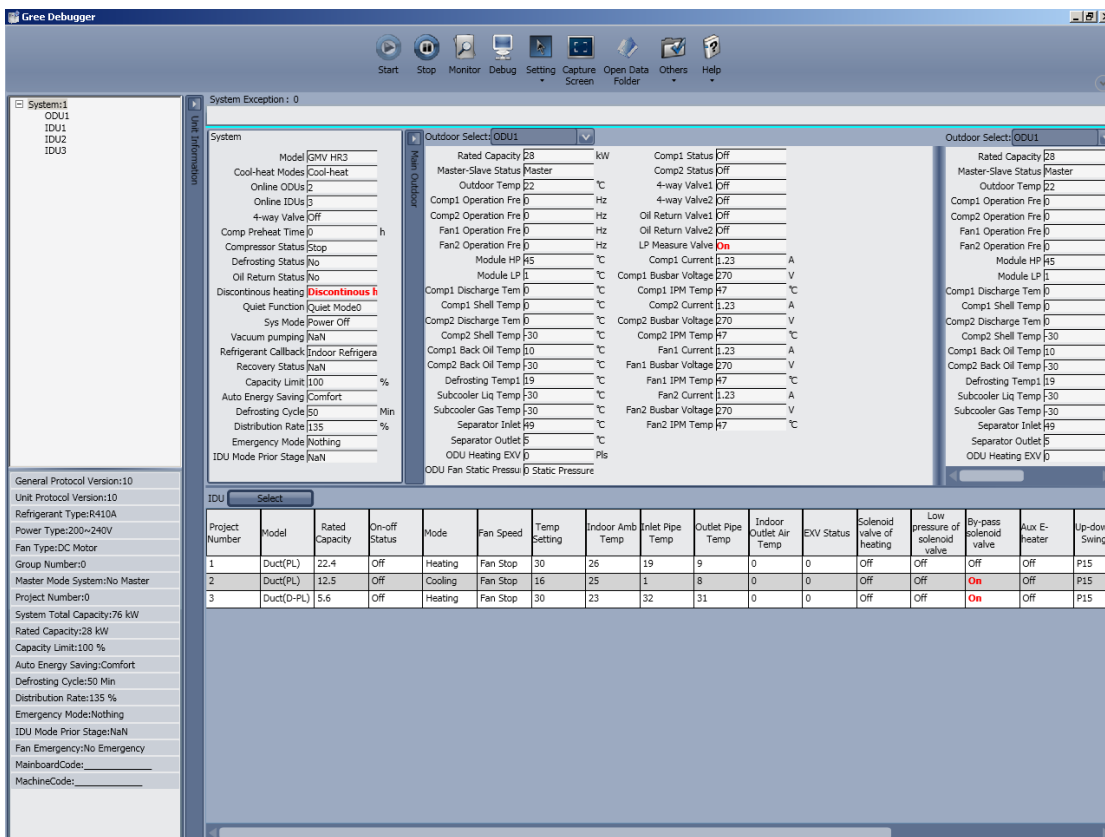

Figure 5

If project commissioning is not finished and all the IDUs' project numbers need to be reset, click Set All IDUs Project Number shown in Figure 2. As shown in Figure 6, the pop-up box comprises two parts: Systems Selection, where you can choose the system to be reset; Settings box, where you can give the resetting instruction.

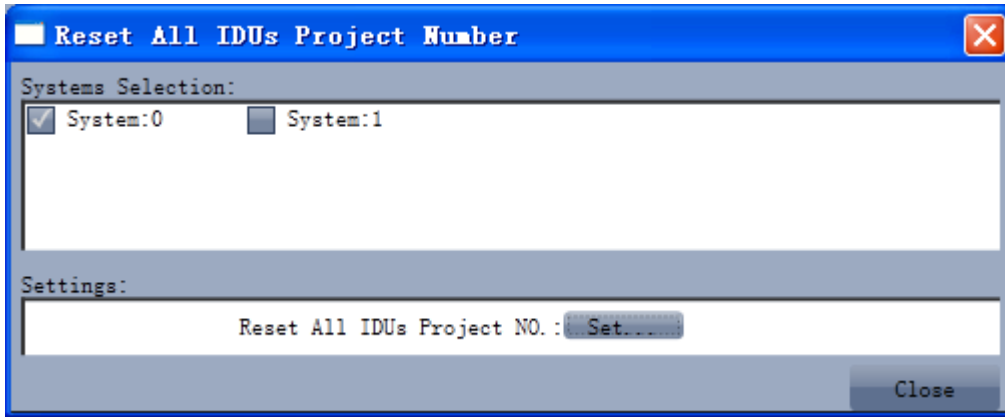

Figure 6

Choose one or multiple systems in the Systems Selection box and click Set in the Settings box, as shown in Figure 6. Click Set, as shown in Figure 7.

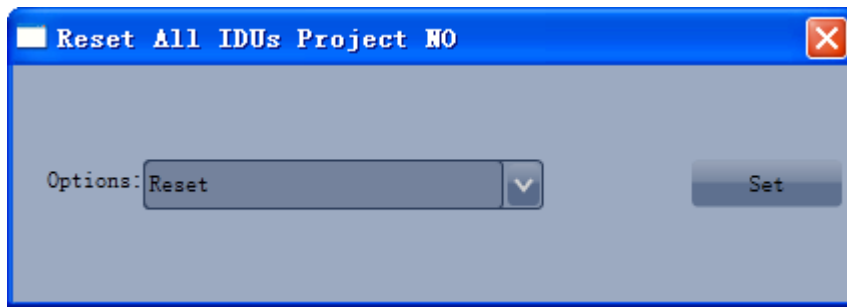

Figure 7

If the conflict is solved, the system will return to the normal status and IDUs can be operated as shown in Figure 5.

② Manual setting on the communicator and remote controller:

When the project number conflict occurs, you can use the communicator or remote controller to revise project numbers and solve the conflict. See the manual of the communicator or remote controller for the method.

③ Setting of auto project number deviation on ODU's main board (recommended)

You can set auto IDU project number deviation via the ODU's main board as follows:

- (1) After the whole system is commissioned, short press SW3 on the controlling unit and the system will enter the standby status as follows:

LED1		LED2		LED3	
Function Code	LED Status	Progress	LED Status	Status	LED Status
A7	Flicker	00	Flicker	00	Flicker
A6	Flicker	00	Flicker	00	Flicker
A2	Flicker	00	Flicker	00	Flicker
A8	Flicker	00	Flicker	00	Flicker
n0	Flicker	01	Flicker	00	Flicker
n1	Flicker	00	Flicker	00	Flicker

LED1		LED2		LED3	
Function Code	LED Status	Progress	LED Status	Status	LED Status
n2	Flicker	00	Flicker	00	Flicker
n3	Flicker	00	Flicker	00	Flicker
n4	Flicker	00	Flicker	00	Flicker
n5	Flicker	00	Flicker	00	Flicker

(2) Press SW2 (▼) on the controlling unit and select n5. Short press SW7 to show the following information:

LED1		LED2		LED3	
Function Code	LED Status	Progress	LED Status	Status	LED Status
n5	Solid On	00	Flicker	OC	Flicker

(3) When project number deviation is to be confirmed, short press SW7 confirmation button to enter the project number deviation status as shown in the following:

LED1		LED2		LED3	
Function Code	LED Status	Current Progress/Mode	LED Status	Status	LED Status
n5	Solid On	00	Solid On	OC	Solid On

IDU project numbers in all systems will automatically deviate. The conflict will be solved in about 1 minute and the system will work properly.

The automatic deviation function only works when it is enabled on the controlling unit in the system, of which the centralized control address is 00000.

**Note:** When there are only a few conflicting IDUs, manual setting is recommended. This method only applies to conflicting IDUs and does only affect other IDUs' project numbers.

In case of many conflicting IDUs, auto deviation is recommended. This method is faster, but may change project numbers of normal IDUs. This method applies for the first commissioning after installation.

Fault code	Fault	Possible reasons	Solution
C2	Communication failure between main control board and inverter compressor drive	1. The control board is powered off; 2. The compressor drive board is powered off; 3. The communication cable between the control board and compressor drive board is not connected; 4. The compressor drive board's dial switch SA201 is wrong.	1. Check the power supply of the control board. Replace the control board if it works properly; 2. Check the power supply of the drive board. Replace the drive board if it works properly; 3. Connect the main board and drive board using the communication cable; 4. Adjust the dial switch of the compressor drive board.
P3	Compressor drive module reset protection	1. The compressor drive board is faulty.	1. Replace the compressor drive board.
P5	Inverter compressor over-current protection	1. The drive board's IPM module is damaged; 2. The compressor's UVW cable is not connected properly; 3. The compressor is damaged.	1. Replace the compressor drive board; 2. Reconnect the compressor's UVW cable; 3. Replace the compressor.
P6	Compressor drive IPM module protection	1. The drive board's IPM module is damaged; 2. The compressor's UVW cable is not connected properly; 3. The compressor is damaged.	1. Replace the compressor drive board; 2. Reconnect the compressor's UVW cable; 3. Replace the compressor.
P7	Compressor drive temperature sensor fault	1. The compressor drive board is faulty.	1. Replace the compressor drive board.

Fault code	Fault	Possible reasons	Solution
P8	Compressor drive IPM over-temperature protection	1. The compressor drive board is faulty; 2. Thermal gel is not applied evenly on the IPM module; 3. The IPM module is not screwed properly.	1. Replace the compressor drive board; 2. Apply thermal gel evenly on the IPM module; 3. Screw the IPM module properly.
P9	Inverter compressor out-of-step protection	The compressor drive board is faulty. The compressor is damaged.	Replace the compressor drive board. Replace the compressor.
PH	Compressor drive DC bus high voltage protection	1. Does the voltage of the input power cable of the whole system exceed 460 V; 2. The compressor drive board is faulty.	1. Lower the voltage of the input power cable to the required range; 2. Replace the compressor drive board.
PL	Compressor drive DC bus low voltage protection	1. Is the voltage of the input power cable of the whole system lower than 320 V; 2. The compressor drive board is faulty.	1. Elevate the voltage of the input power cable to the required range; 2. Replace the compressor drive board.
PC	Compressor drive current check circuit fault	1. The compressor drive board is faulty.	1. Replace the compressor drive board.
PF	Compressor drive recharging circuit fault	1. Is the voltage of the input power cable of the whole system lower than 280 V; 2. The compressor drive board is faulty.	1. Elevate the voltage of the input power cable to the required range; 2. Replace the compressor drive board.
PJ	Inverter compressor starting failure	1. The drive board is damaged; 2. The compressor's UVW cable is not connected properly; 3. The compressor is damaged.	1. Replace the compressor drive board; 2. Reconnect the compressor's UVW cable; 3. Replace the compressor.
C3	Communication failure between main control board and variable frequency fan drive	1. The control board is powered off; 2. The fan drive board is powered off; 3. The communication cable between the control board and fan drive board is not connected; 4. The fan drive board's dial switch is wrong.	1. Check the power supply of the control board. Replace the control board if it works properly; 2. Check the power supply of the drive board. Replace the drive board if it works properly; 3. Connect the main board and drive board using the communication cable; 4. Adjust the dial switch of the fan drive board.
H3	Fan drive module reset protection	1. The fan drive board is faulty.	1. Replace the fan drive board.
H5	Variable frequency fan over-current protection	1. The fan drive board's IPM module is damaged; 2. The fan's UVW cable is not connected properly; 3. The fan is damaged.	1. Replace the fan drive board; 2. Reconnect the fan's UVW cable; 3. Replace the fan.
H6	Fan drive IPM module protection	1. The fan drive board's IPM module is damaged; 2. The fan's UVW cable is not connected properly; 3. The fan is damaged.	1. Replace the fan drive board; 2. Reconnect the fan's UVW cable; 3. Replace the fan.
H7	Fan drive temperature sensor fault	1. The fan drive board is faulty.	1. Replace the fan drive board.
H8	Fan drive IPM over-temperature protection	1. The fan drive board is faulty; 2. Thermal gel is not applied evenly on the IPM module; 3. The IPM module is not screwed properly.	1. Replace the fan drive board; 2. Apply thermal gel evenly on the IPM module; 3. Screw the IPM module properly.
H9	Variable frequency fan out-of-step protection	The fan drive board is faulty. The fan is damaged.	Replace the fan drive board. Replace the fan.
HH	Fan drive DC bus high voltage protection	1. Does the voltage of the input power cable of the whole system exceed 460 V; 2. The fan drive board is faulty.	1. Lower the voltage of the input power cable to the required range; 2. Replace the fan drive board.
HL	Fan drive DC bus low voltage protection	1. Is the voltage of the input power cable of the whole system lower than 320 V; 2. Is the fan drive board well	1. Elevate the voltage of the input power cable to the required range; 2. Connect the fan drive board with the compressor drive board according to the wiring



Fault code	Fault	Possible reasons	Solution
		connected with the compressor drive board; 3. The fan drive board is faulty.	diagram; 3. Replace the fan drive board.
HC	Fan drive current detection circuit fault	1. The fan drive board is faulty.	1. Replace the fan drive board.
HJ	Variable frequency fan starting failure	1. The drive board is damaged; 2. The fan's UVW cable is not connected properly; 3. The fan is damaged.	1. Replace the fan drive board; 2. Reconnect the fan's UVW cable; 3. Replace the fan.

## 2.3 System faults

### 2.3.1 System exhaust temperature exception

Fault code	Fault	Possible reasons						Solution
		Primary reason		Secondary reason		Tertiary reason		
		Description	Confirmation method	Description	Confirmation method	Description	Confirmation method	
E4	High exhaust temperature protection	1. The stop valve of the ODU is not fully opened as required.	—	—	—	—	Manual check	Fully open the stop valve.
		2. The IDU's electronic expansion valve is not working properly.	When the IDU is working in the cooling mode and the electronic expansion valve is opened to 2000PLS, the exhaust temperature of the IDU's coil is more than 15°C higher than the intake temperature; when the IDU is working in the heating mode and the electronic expansion valve is opened to 2000PLS, the intake temperature of the IDU's coil is more than 10°C higher than the intake temperature;	2.1 The controlling of electronic expansion valve by main board of indoor unit is abnormal.	Reset the IDU. Listen to the sound and touch the tube to see if the electronic expansion valve is reset. If it is set, it is normal. Otherwise, it is faulty.	2.1.1 The control wire of the electronic expansion valve is not connected to the main board.	Manual check	Connect the electronic expansion valve's control wire to the main board.
						2.1.2 The control wire that connects the electronic expansion valve to the main board is broken.		Repair or replace the control wire of the electronic expansion valve.
				2.2 The electronic expansion valve in the mode switcher is faulty.	Other reasons	2.2.1 Affected by impurities in the system	—	Clean the system and clear the impurities. Replace the body of the electronic expansion valve.
		2.2.2 The valve body is faulty.	—			Replace the body of the electronic expansion valve.		
3. The system pipeline is blocked.	The system's exhaust temperature rises and the low pressure is too low (compared	3.1 The fluid pipe is blocked.	Touch the pipe along the flowing direction of refrigerant to feel the temperature difference. The	—	—	Replace and solder the pipe.		

Fault code	Fault	Possible reasons						Solution
		Primary reason		Secondary reason		Tertiary reason		
		Description	Confirmation method	Description	Confirmation method	Description	Confirmation method	
			with the reference value).	3.2 The air pipe is blocked.	difference is large or part of the pipe is frosting.	—	—	Replace and solder the pipe.
				3.3 The pipe that connects the IDU is blocked.	Touch the pipe along the flowing direction of refrigerant to feel the temperature difference. The difference is large or part of the pipe is frosting.	3.3.1 The block is caused by solder.	Cut off the pipe to see if it is blocked.	Replace and solder the pipe.
						3.3.2 The pipeline is blocked by impurities.		Replace and solder the pipe.
		4. Lacking refrigerant	The system's exhaust temperature rises and the low pressure is too low (compared with the reference value).	4.1 Not enough refrigerant	—	—	—	Inject refrigerant as required.
				4.2 Refrigerant pipe leakage	Use the refrigerant leak detector to detect the leak along the pipe.	—	—	Stop the leak. Pump out air and inject refrigerant again.
		5. Wrong refrigerant is injected.	Stop the whole system. Test the system's balance pressure 20 minutes later and convert the pressure into the corresponding saturation temperature. Compare it with the outdoor ambient temperature. If the difference is larger than 5°C, it is exceptional.	—	—	—	—	Discharge existing refrigerant and inject the correct refrigerant as required.
		6. Exhaust temperature sensor failure	—	—	—	—	—	Replace the temperature sensor or main board.
		7. The ambient temperature exceeds the scope of temperature required for safe operation.	—	The outdoor ambient temperature exceeds 50°C.	Measure the ambient temperature.	—	—	It is a normal phenomenon caused by the protection function.

Fault code	Fault	Possible reasons						Solution
		Primary reason		Secondary reason		Tertiary reason		
		Description	Confirmation method	Description	Confirmation method	Description	Confirmation method	
E2	Low exhaust temperature protection	1. The ODU's electronic expansion valve is not working properly.	When the system is working in the heating mode and the ODU's electronic expansion valve is opened to 100PLS, the intake temperature of the corresponding liquid-air separator is more than 1°C lower than the low-pressure saturation temperature and the difference between the compressor's exhaust temperature or cover temperature and the high-pressure temperature is smaller than 10°C.	1.2 The controlling heating electronic expansion of the main board or the electronic expansion valve of the subcooler is faulty.	Reset the ODU. Listen to the sound and touch the tube to see if the electronic expansion valve is reset. If it is set, it is normal. Otherwise, it is faulty.	1.2.1 The control wire of the electronic expansion valve is not connected to the main board.	Manual check	Connect the electronic expansion valve's control wire to the main board.
								1.2.2 The control wire that connects the electronic expansion valve to the main board is broken.
				1.3 The body of the electronic expansion valve is not working properly.	Other reasons	1.3.1 Affected by impurities in the system	—	Clean the system and clear the impurities. Replace the body of the electronic expansion valve.
			1.3.2 The body of the valve is faulty.	—		Replace the body of the electronic expansion valve.		
		2. The IDU's electronic expansion valve is not working properly	When the system is working in the cooling mode and the ODU's electronic expansion valve is opened to 200PLS, the exhaust temperature of the IDU's coil is more than 1°C lower than the intake pipe's temperature and the difference between the compressor's exhaust temperature or cover	2.1 The controlling of electronic expansion valve by main board of indoor unit is abnormal.	Reset the IDU. Listen to the sound and touch the tube to see if the electronic expansion valve is reset. If it is set, it is normal. Otherwise, it is faulty.	2.1.1 The control wire of the electronic expansion valve is not connected to the main board.	Manual check	Connect the electronic expansion valve's control wire to the main board.
						2.1.2 The control wire that connecting the electronic expansion valve to the main board is broken.		Manual check
2.2 The body of the electronic expansion valve is not working properly.	Other reasons			2.2.1 Affected by impurities in the system	—	Clean the system and clear the impurities. Replace the body of the electronic expansion valve.		

Fault code	Fault	Possible reasons						Solution
		Primary reason		Secondary reason		Tertiary reason		
		Description	Confirmation method	Description	Confirmation method	Description	Confirmation method	
			temperature and the high-pressure temperature is smaller than 10°C.			2.2.2 The valve body is faulty.	—	Replace the body of the electronic expansion valve.
		3. Exhaust temperature sensor failure	—	—	—	—	—	Replace the temperature sensor or main board.
		4. Too much refrigerant	Other reasons	Incorrect quantity of refrigerant is injected.	—	—	—	Check the necessary amount of refrigerant and discharge the unneeded refrigerant slowly via the stop valve of the fluid pipe.

### 2.3.2 Pressure exception

Fault code	Fault	Possible reasons						Solution
		Primary reason		Secondary reason		Tertiary reason		
		Description	Confirmation method	Description	Confirmation method	Description	Confirmation method	
E1	High pressure protection	1. The stop valve of the ODU is not fully opened as required.	—	—	—	—	Manual check	Fully open the stop valve.
		2. The system pipeline is blocked.	The system's exhaust pressure rises and the low pressure is too low (compared with the reference value).	2.1. The system air pipeline is blocked.	Touch the pipe along the flowing direction of refrigerant to feel the temperature difference. The difference is large.	2.1.1 The block is caused by solder.	Cut off the pipe and check it.	Replace and solder the pipe.
				2.2 The fluid pipe is blocked.		Touch the pipe along the flowing direction of refrigerant to feel the temperature difference. The difference is large or part of the pipe is frosting.		2.1.2 The pipeline is blocked by impurities.

Fault code	Fault	Possible reasons						Solution
		Primary reason		Secondary reason		Tertiary reason		
		Description	Confirmation method	Description	Confirmation method	Description	Confirmation method	
				2.4 The pipe that connects the IDU is blocked.	Touch the pipe along the flowing direction of refrigerant to feel the temperature difference. The difference is large or part of the pipe is frosting.	2.4.1 The block is caused by solder.	Cut off the pipe and check it.	Replace and solder the pipe.
					2.4.2 The pipeline is blocked by impurities.	Replace and solder the pipe.		
	3. The ambient temperature is too high.			3.1 In the cooling mode, the outdoor temperature is over 50°C.	Measure the outdoor ambient temperature.	—	—	It is a normal phenomenon caused by the protection function.
				3.2 In the heating mode, the actual ambient temperature of the IDU's return air is over 30°C.	Measure the temperature of the unit's return air.	—	—	It is a normal phenomenon caused by the protection function.
	4. The pressure sensor is faulty.			4.1 The high pressure sensor is faulty.	Stop the whole system. Test the system's balance pressure 20 minutes later and convert the pressure into the corresponding saturation temperature. Compare it with the outdoor ambient temperature. If the difference is larger than 5°C, it is exceptional.	—	—	Replace the high pressure sensor.
				4.2 The high pressure and low pressure sensors are connected reversely.	Connect the stop valve of the module fluid pipe and air pipe to the high and low pressure gauges and transform the readings into corresponding temperatures. Compare them to the high- and low-temperatures tested by the system. If the difference is larger than 5°C, it is exceptional.	—	—	Reconnect the high- and low-pressure sensors.
	5. The high pressure switch is faulty.	E1 protection is displayed on the unit when it is powered on.	5.1 The high pressure switch is not connected to the main board.	—	5.1.1 The pressure switch is not connected to the main board.	—	—	Reconnect it.

Fault code	Fault	Possible reasons						Solution
		Primary reason		Secondary reason		Tertiary reason		
		Description	Confirmation method	Description	Confirmation method	Description	Confirmation method	
					—	5.1.2 The connect wire between the pressure switch and main board is faulty.	—	Reconnect them with the wire.
				5.2 The high pressure switch is damaged.	—	—	—	Replace the pressure switch.
						6.1.1 The power cable connecting the motor and main board is loose.	Manual check	Reconnect the motor with the power cable.
				6.1 The IDU's fan is faulty.	Manual check	6.1.2 The electric capacity is not connected or is damaged.	Manual check	Connect or replace the electric capacity.
						6.1.3 The motor is damaged.	Other reasons	Replace the motor.
						6.2.1 The fan motor is not properly connected with the control board of the motor with the power cable.	Manual check	Reconnect it properly.
						6.2.2 The fan motor is not properly connected with the control board of the motor with the signal feedback cable.	Manual check	Reconnect it properly.
						6.2.3 The control board of the fan's motor is damaged.	Manual check	Replace the control board of the motor.
						6.2.4 The main board of the fan's motor is damaged.	Other reasons	Replace the motor.
		6. The fan is not working properly.	A. The ODU's fan does not work in the cooling mode. B. The IDU's motor does not work in the heating mode.					
				6.2 The ODU's fan is faulty.	Manual check			

Fault code	Fault	Possible reasons						Solution
		Primary reason		Secondary reason		Tertiary reason		
		Description	Confirmation method	Description	Confirmation method	Description	Confirmation method	
		7. Too much refrigerant	Other reasons	Incorrect quantity of refrigerant is injected.	—	—	—	Check the necessary amount of refrigerant and discharge unneeded refrigerant slowly via the stop valve of the fluid pipe.
JL	Low high pressure protection	1. The ambient temperature exceeds the range.	—	1.1 The outdoor ambient temperature in the cooling mode is lower than -10°C.	Measure the outdoor ambient temperature.	—	—	It is a normal phenomenon caused by the protection function.
				1.2 The indoor ambient temperature in the heating mode is lower than 5°C.	Measure the temperature of the unit's return air.	—	—	It is a normal phenomenon caused by the protection function.
		2. Not enough refrigerant	—					Locate the leak and inject refrigerant.

Fault code	Fault	Possible reasons						Solution
		Primary reason		Secondary reason		Tertiary reason		
		Description	Confirmation method	Description	Confirmation method	Description	Confirmation method	
E3	Low-pressure Protection	1. The stop valve of the ODU is not fully opened as required.	—	—	—	—	Manual check	Fully open the stop valve.
		2. The system pipeline is blocked.	The system's exhaust pressure rises and the low pressure is too low (compared with the reference value).	2.1. The system air pipeline is blocked.	Touch the pipe along the flowing direction of refrigerant to feel the temperature difference. The difference is large.	2.1.1 The block is caused by solder.	Cut off the pipe and check it.	Replace and solder the pipe.
				2.2 The fluid pipe is blocked.	Touch the pipe along the flowing direction of refrigerant to feel the temperature	2.1.2 The pipeline is blocked by impurities.		—

Fault code	Fault	Possible reasons						Solution
		Primary reason		Secondary reason		Tertiary reason		
		Description	Confirmation method	Description	Confirmation method	Description	Confirmation method	
					difference. The difference is large or part of the pipe is frosting.			
				2.4 The pipe that connects the IDU is blocked.	Touch the pipe along the flowing direction of refrigerant to feel the temperature difference. The difference is large or part of the pipe is frosting.	2.4.1 The block is caused by solder.	Cut off the pipe and check it.	Replace and solder the pipe.
						2.4.2 The pipeline is blocked by impurities.		Replace and solder the pipe.
		3. The ambient temperature is too low.	—	3.1 The outdoor ambient temperature is lower than -25°C in the heating mode.	Measure the outdoor ambient temperature.	—	—	It is a normal phenomenon caused by the protection function.
		4. The pressure sensor is faulty.	—	4.1 The low pressure sensor is faulty.	Stop the whole system. Test the system's balance pressure 20 minutes later and convert the pressure into the corresponding saturation temperature. Compare it with the outdoor ambient temperature. If the difference is larger than 5°C, it is exceptional.	—	—	Replace the high pressure sensor.
				4.2 The high pressure and low pressure sensors are connected reversely.	Connect the stop valves of the module high- and low-pressure air pipes to the high and low pressure gauges and transform the readings into corresponding temperatures. Compare them to the high- and low-temperatures tested by the system. If the difference is larger than 5°C, it is exceptional.	—	—	Reconnect the high- and low-pressure sensors.



Fault code	Fault	Possible reasons						Solution		
		Primary reason		Secondary reason		Tertiary reason				
		Description	Confirmation method	Description	Confirmation method	Description	Confirmation method			
		6. The fan is not working properly.	A. The IDU's fan does not work in the cooling mode. B. The ODU's fan does not work in the heating mode.	6.1 The IDU's fan is faulty.	Manual check	6.1.1 The power cable connecting the motor and main board is loose.	Manual check	Reconnect the motor with the power cable.		
						6.1.2 The electric capacity is not connected or is damaged.	Manual check	Connect or replace the electric capacity.		
						6.1.3 The motor is damaged.	Other reasons	Replace the motor.		
						6.2 The ODU's fan is faulty.	Manual check	6.2.1 The fan motor is not properly connected with the control board of the motor.	Manual check	Reconnect it properly.
								6.2.2 The fan motor is not properly connected with the control board of the motor with the communication feedback cable.	Manual check	Reconnect it properly.
								6.2.3 The control board of the fan's motor is damaged.	Manual check	Replace the control board of the motor.
								6.2.4 The main board of the fan's motor is damaged.	Other reasons	Replace the motor.
				7. Not enough refrigerant	Other reasons	Incorrect quantity of refrigerant is injected.	—	—	—	Check the necessary amount of refrigerant and inject refrigerant slowly via the stop valve of the low-pressure air pipe.

### 2.3.3 Poor cooling/heating performance

Feedback from user	Exception	Possible reasons						Solution
		Primary reason		Secondary reason		Tertiary reason		
		Description	Confirmation method	Description	Confirmation method	Description	Confirmation method	
Poor heating/cooling performance	A. When the IDU is working in the cooling mode and the electronic expansion valve is opened to the max., the exhaust temperature of the IDU's coil is more than 5°C higher than the intake temperature; B. when the IDU is working in the heating mode and the electronic expansion valve is opened to 2PLS, the intake temperature of the IDU's coil is more than 12°C lower than the saturation temperature corresponding to the high pressure;	1. The stop valve of the ODU is not fully opened as required.	—	—	—	—	Manual check	Fully open the stop valve.
		2. The system pipeline is blocked.	—	2.1. The system air pipeline is blocked.	Touch the pipe along the flowing direction of refrigerant to feel the temperature difference. The difference is large.	2.1.1 The block is caused by solder.	Cut off the pipe and check it.	Replace and solder the pipe.
						2.1.2 The pipeline is blocked by impurities.		Replace and solder the pipe.
				2.2 The fluid pipe is blocked.	Touch the pipe along the flowing direction of refrigerant to feel the temperature difference. The difference is large or part of the pipe is frosting.	—	—	Replace and solder the pipe.
						2.4 The pipe that connects the IDU is blocked.	Touch the pipe along the flowing direction of refrigerant to feel the temperature difference. The difference is large or part of the pipe is frosting.	2.4.1 The block is caused by solder.
		2.4.2 The pipeline is blocked by impurities.	Replace and solder the pipe.					
		3. The ambient temperature exceeds the required range.	—	3.1 The ambient temperature of the IDU that works in the cooling mode is higher than 32°C.	Measure the outdoor ambient temperature.	3.1.1 The system has worked for less than 1 hour.	—	It is a normal phenomenon.
						3.1.2 An improper system is selected.	—	Choose another system with larger power.
		3.2 The outdoor ambient temperature in the cooling mode is	—	—	—	—	—	It is a normal phenomenon.

Feedback from user	Exception	Possible reasons						Solution
		Primary reason		Secondary reason		Tertiary reason		
		Description	Confirmation method	Description	Confirmation method	Description	Confirmation method	
				higher than 40°C.				
				3.3 The ambient temperature of the IDU that works in the heating mode is lower than 12°C.	Measure the outdoor ambient temperature.	3.3.1 The system has worked for less than 2 hours.	—	It is a normal phenomenon.
						3.3.2 An improper system is selected.	—	Choose another system with larger power.
				3.4 The outdoor ambient temperature in the heating mode is lower than -7°C.	Measure the outdoor ambient temperature.	—	—	It is a normal phenomenon.
		4. Poor airflow distribution design	—	4.1 The air intake and return inlet of the ODU are too close to each other, affecting the heat exchange performance of the unit.	Check the distance.	—	—	Re-design the airflow distribution.
				4.2 The air intake and return inlet of the IDU are too close to each other, causing poor heat exchange of the unit.	Check the distance.	—	—	Re-design the airflow distribution.
		7. Not enough refrigerant	Other reasons	Incorrect quantity of refrigerant is injected.	—	—	—	Check the necessary amount of refrigerant and inject refrigerant slowly via the stop valve of the low-pressure air pipe.

## 2.3.4 Exception Analyzing and Troubleshooting

### 2.3.4.1 “A0” Unit debug status

**Error display:** ODU mainboard, IDU wired controller and IDU receive light board will

display 

**Error judgment condition and method:**

This code is status code. When the engineering debugging is not completed, the unit will display this code, at this time, the unit cannot startup for operation.

**Possible reason:** ——

**Troubleshooting:** status code, no troubleshooting.

### 2.3.4.2 “A2” Refrigerant recovery operation status

**Error display:** ODU mainboard, IDU wired controller and IDU receive light board will

display 

**Error judgment condition and method:**

This code is status code, which means the system has entered into refrigerant recovery status, and the unit will start up for operation automatically.

**Possible reason:** ——

**Troubleshooting:** status code, no troubleshooting.

### 2.3.4.3 “A3” Defrosting status

**Error display:** ODU mainboard, IDU wired controller and IDU receive light board will

display 

**Error judgment condition and method:**

This code is status code, which means the system has entered into defrosting status, the operating IDU fan will stop for 5-10 minutes.

**Possible reason:** ——

**Troubleshooting:** status code, no troubleshooting.

### 2.3.4.4 “A4” Oil return status

**Error display:** ODU mainboard, IDU wired controller and IDU receive light board will

display 

**Error judgment condition and method:**

This code is status code, which means the system has entered into oil return status, if returning oil under heating mode, the operating IDU will stop for 5-10 minutes.

**Possible reason:** ——

**Troubleshooting:** status code, no troubleshooting.

#### 2.3.4.5 “A6” Cooling and heating function setting status

**Error display:** ODU mainboard will display



**Error judgment condition and method:**

This code is status code, which means the system has entered into cooling and heating function setting status. At this time, cooling & heating mode (nA), cooling only mode (nC), heating only mode (nH) and supply air mode (nF) are selectable.

**Possible reason:** ——

**Troubleshooting:** status code, no troubleshooting.

#### 2.3.4.6 “A7” Quiet mode setting status

**Error display:** ODU mainboard will display



**Error judgment condition and method:**

This code is status code, which means the system has entered into quiet mode setting status.

**Possible reason:** ——

**Troubleshooting:** status code, no troubleshooting.

#### 2.3.4.7 “A8” Vacuum mode

**Error display:** ODU mainboard will display



**Error judgment condition and method:**

This code is status code, which means the system has entered into vacuum mode, corresponding expansion valve and solenoid valve will open.

**Possible reason:** ——

**Troubleshooting:** status code, no troubleshooting.

#### 2.3.4.8 “AH” Heating status

**Error display:** ODU mainboard will display



**Error judgment condition and method:**

This code is status code, which means the system has entered into heating mode for operation.

**Possible reason:** ——

**Troubleshooting:** status code, no troubleshooting.

#### 2.3.4.9 “AC” Cooling status

**Error display:** ODU mainboard will display



**Error judgment condition and method:**

This code is status code, which means the system has entered into cooling mode for operation.

**Possible reason:** ——

**Troubleshooting:** status code, no troubleshooting.

#### 2.3.4.10 “AF” Supply air status

**Error display:** ODU mainboard will display



**Error judgment condition and method:**

This code is status code, which means the system has entered into supply air mode, at this time, all IDUs can only be operated under supply air mode.

**Possible reason:** ——

**Troubleshooting:** status code, no troubleshooting.

#### 2.3.4.11 “AE” Manual refrigerant charging status

**Error display:** ODU mainboard will display



**Error judgment condition and method:**

This code is status code, which means the system adopts manual refrigerant charging status.

**Possible reason:** ——

**Troubleshooting:** status code, no troubleshooting.

#### 2.3.4.12 “AJ” Filter dirty alarm

**Error display:** IDU wired controller and IDU receive light board will display



**Error judgment condition and method:**

This code is status code, which means the indoor unit has entered filter dirty period, the filter need cleaning. The period can be set according to actual operating environment.

**Possible reason:** ——

**Troubleshooting:** Clean the filter and eliminate remind to enter into the next service cycle.

#### 2.3.4.13 “AP” Unit startup debug confirmation

**Error display:** ODU mainboard will display



**Error judgment condition and method:**

This code is status code, which means whether it is ready for the debug procedure or not or unit status can be started.

**Possible reason:** ——

**Troubleshooting:** status code, no troubleshooting.

#### 2.3.4.14 “AU” Long-distance control emergency stop status

**Error display:** ODU mainboard, IDU wired controller and IDU receive light board will display

**Error judgment condition and method:**

This code is status code, which means the unit has been long-distance controlled as emergency stop status, unless the status is removed, otherwise, you cannot start up the unit for operation.

**Possible reason:** ——

**Troubleshooting:** status code, no troubleshooting.

#### 2.3.4.15 “Ab” Emergency stop operation status

**Error display:** ODU mainboard, IDU wired controller and IDU receive light board will display

**Error judgment condition and method:**

This code is status code, which means ODU mainboard has received the external emergency stop signal, unless the status is removed, otherwise, you cannot start up the unit for operation.

**Possible reason:** ——

**Troubleshooting:** status code, no troubleshooting.

#### 2.3.4.16 “Ad” Limited operation status

**Error display:** ODU mainboard, IDU wired controller and IDU receive light board will display

**Error judgment condition and method:**

This code is status code, which means the system has set the emergency operation status, but emergency operation time has exceed the limited requirements, at this time, the unit is not allowed to conduct emergency operation.

**Possible reason:** ——

**Troubleshooting:** status code, no troubleshooting.

#### 2.3.4.17 “b1” Outdoor ambient temperature sensor error

**Error display:** ODU mainboard, IDU wired controller and IDU receive light board will display

**Error judgment condition and method:**

Sample the AD value of temperature sensor through temperature sensor detecting circuit and judge the range of AD value; if the sampled AD value exceeds upper limit and lower limit in 30 seconds continuously, report the error.

**Possible reason:**

- Poor contact between temperature sensor and terminal in mainboard interface

- Temperature sensor is abnormal
- Detecting circuit is abnormal

**Troubleshooting:**

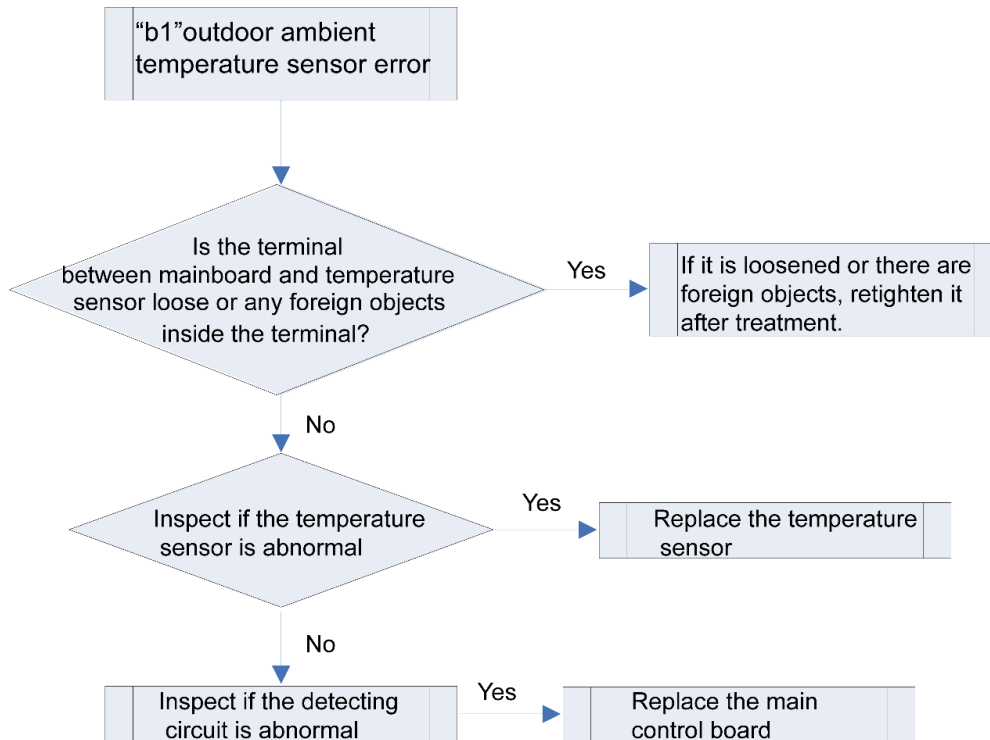

#### 2.3.4.18 “b2” Defrost temperature sensor 1 error

**Error display:** ODU mainboard, IDU wired controller and IDU receive light board will display



**Error judgment condition and method:**

Sample the AD value of temperature sensor through temperature sensor detecting circuit and judge the range of AD value; if the sampled AD value exceeds upper limit and lower limit in 30 seconds continuously, report the error.

**Possible reason:**

- Poor contact between temperature sensor and terminal in mainboard interface
- Temperature sensor is abnormal
- Detecting circuit is abnormal

**Troubleshooting:**



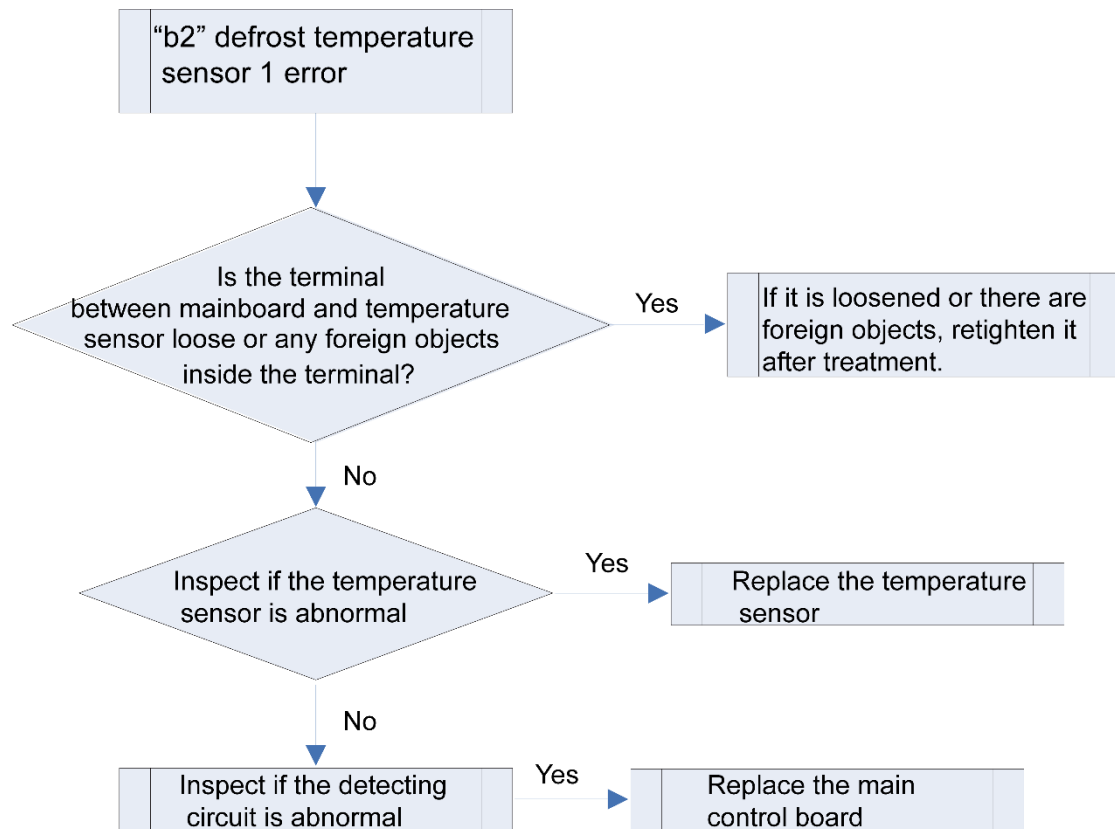

#### 2.3.4.19 "b3" Defrost temperature sensor 2 error

**Error display:** ODU mainboard, IDU wired controller and IDU receive light board will

display 

**Error judgment condition and method:**

Sample the AD value of temperature sensor through temperature sensor detecting circuit and judge the range of AD value; if the sampled AD value exceeds upper limit and lower limit in 30 seconds continuously, report the error.

**Possible reason:**

- Poor contact between temperature sensor and terminal in mainboard interface
- Temperature sensor is abnormal
- Detecting circuit is abnormal

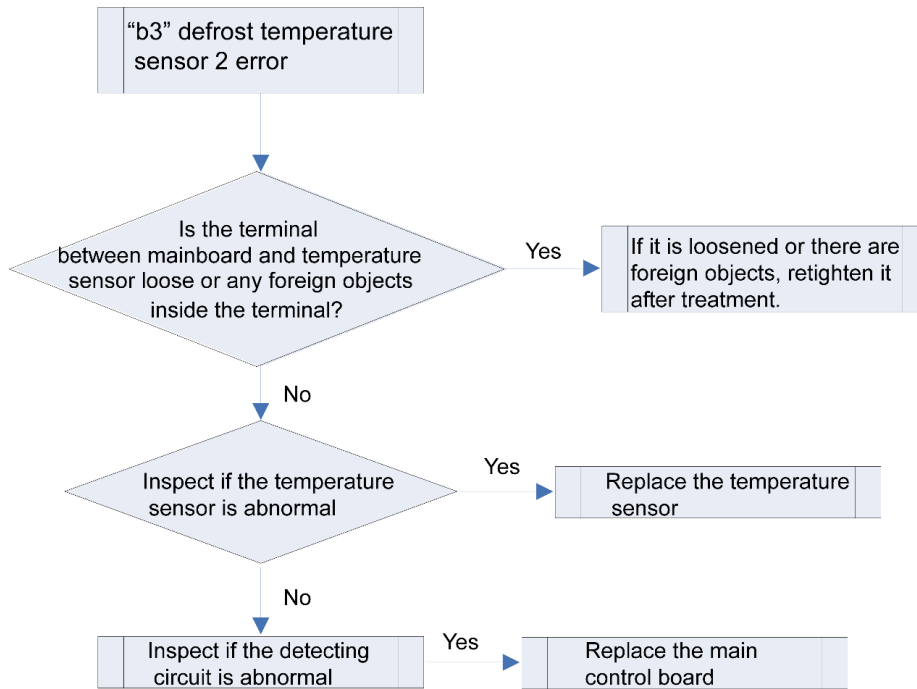
**Troubleshooting:**

## 2.3.4.20 “b4” Malfunction of liquid temperature sensor of sub-cooler

**Error display:** ODU mainboard, IDU wired controller and IDU receive light board will

display 

**Error judgment condition and method:**

Sample the AD value of temperature sensor through temperature sensor detecting circuit and judge the range of AD value; if the sampled AD value exceeds upper limit and lower limit in 30 seconds continuously, report the error.

**Possible reason:**

- Poor contact between temperature sensor and terminal in mainboard interface
- Temperature sensor is abnormal
- Detecting circuit is abnormal

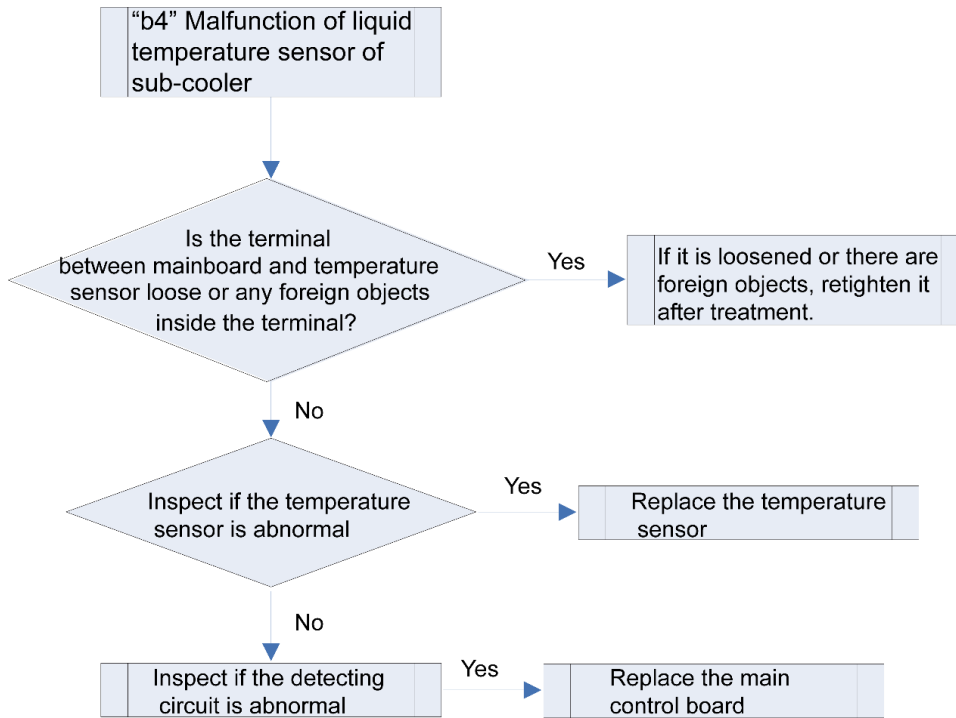
**Troubleshooting:**

## 2.3.4.21 “b5” Malfunction of gas temperature sensor of sub-cooler

**Error display:** ODU mainboard, IDU wired controller and IDU receive light board will

display 

**Error judgment condition and method:**

Sample the AD value of temperature sensor through temperature sensor detecting circuit and judge the range of AD value; if the sampled AD value exceeds upper limit and lower limit in 30 seconds continuously, report the error.

**Possible reason:**

- Poor contact between temperature sensor and terminal in mainboard interface
- Temperature sensor is abnormal
- Detecting circuit is abnormal

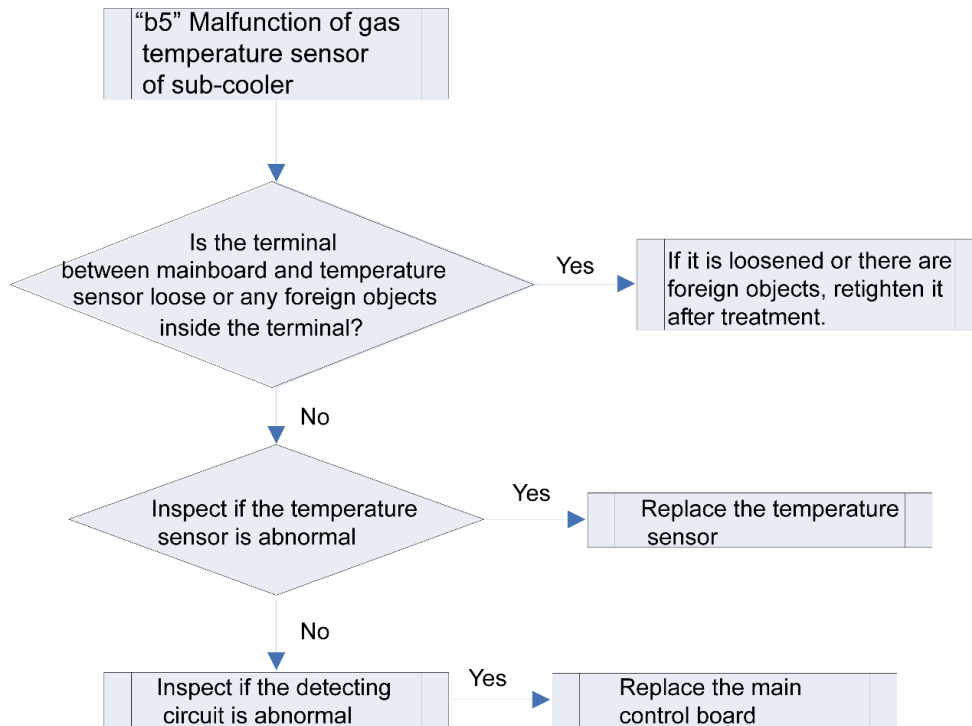
**Troubleshooting:**

## 2.3.4.22 “b6” Malfunction of inlet tube temperature sensor of vapor liquid separator

**Error display:** ODU mainboard, IDU wired controller and IDU receive light board will display

**Error judgment condition and method:**

Sample the AD value of temperature sensor through temperature sensor detecting circuit and judge the range of AD value; if the sampled AD value exceeds upper limit and lower limit in 30 seconds continuously, report the error.

**Possible reason:**

- Poor contact between temperature sensor and terminal in mainboard interface
- Temperature sensor is abnormal
- Detecting circuit is abnormal

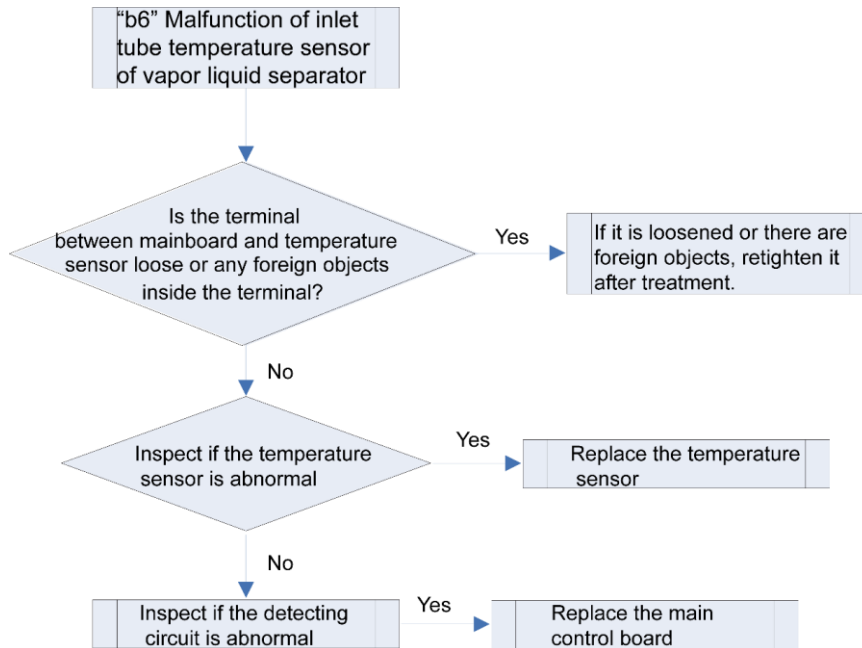
**Troubleshooting:**

## 2.3.4.23 “b7” Malfunction of exit tube temperature sensor of vapor liquid separator

**Error display:** ODU mainboard, IDU wired controller and IDU receive light board will display

**Error judgment condition and method:**

Sample the AD value of temperature sensor through temperature sensor detecting circuit and judge the range of AD value; if the sampled AD value exceeds upper limit and lower limit in 30 seconds continuously, report the error.

**Possible reason:**

- Poor contact between temperature sensor and terminal in mainboard interface
- Temperature sensor is abnormal
- Detecting circuit is abnormal

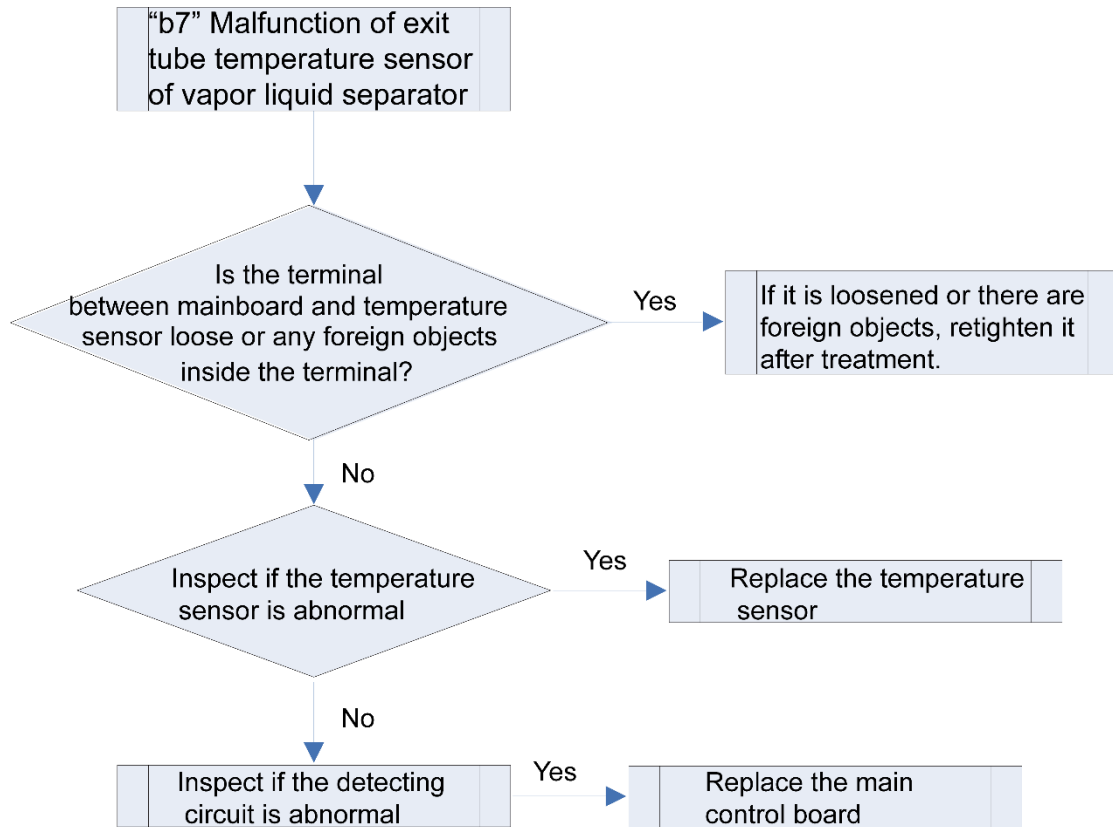
**Troubleshooting:**

## 2.3.4.24 “b8” Malfunction of outdoor humidity sensor

**Error display:** ODU mainboard, IDU wired controller and IDU receive light board will display

**Error judgment condition and method:**

Sample the AD value of temperature sensor through temperature sensor detecting circuit and judge the range of AD value; if the sampled AD value exceeds upper limit and lower limit in 30 seconds continuously, report the error.

**Possible reason:**

- Poor contact between temperature sensor and terminal in mainboard interface
- Temperature sensor is abnormal
- Detecting circuit is abnormal

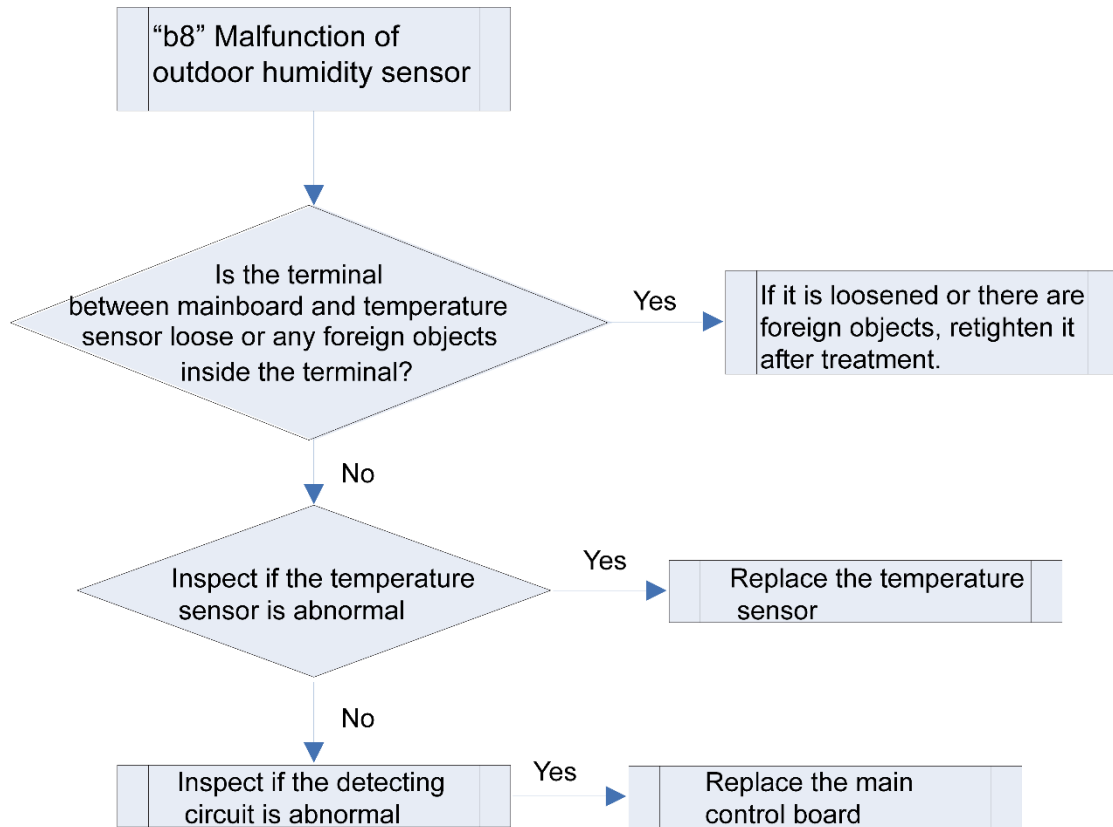
**Troubleshooting:**

## 2.3.4.25 “b9” Malfunction of gas temperature sensor of heat exchanger

**Error display:** ODU mainboard, IDU wired controller and IDU receive light board will display

**Error judgment condition and method:**

Sample the AD value of temperature sensor through temperature sensor detecting circuit and judge the range of AD value; if the sampled AD value exceeds upper limit and lower limit in 30 seconds continuously, report the error.

**Possible reason:**

- Poor contact between temperature sensor and terminal in mainboard interface
- Temperature sensor is abnormal
- Detecting circuit is abnormal

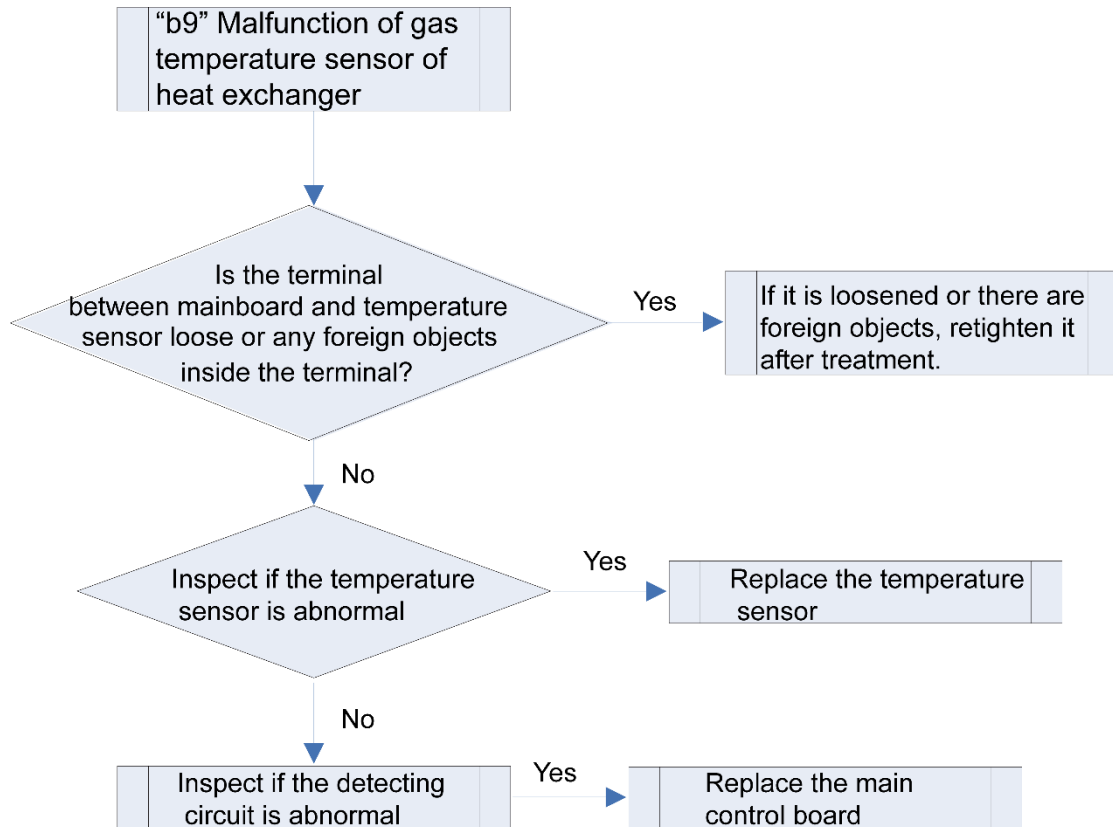
**Troubleshooting:**

## 2.3.4.26 “bA” Malfunction of oil-return temperature sensor

**Error display:** ODU mainboard, IDU wired controller and IDU receive light board will display

**Error judgment condition and method:**

Sample the AD value of temperature sensor through temperature sensor detecting circuit and judge the range of AD value; if the sampled AD value exceeds upper limit and lower limit in 30 seconds continuously, report the error.

**Possible reason:**

- Poor contact between temperature sensor and terminal in mainboard interface
- Temperature sensor is abnormal
- Detecting circuit is abnormal

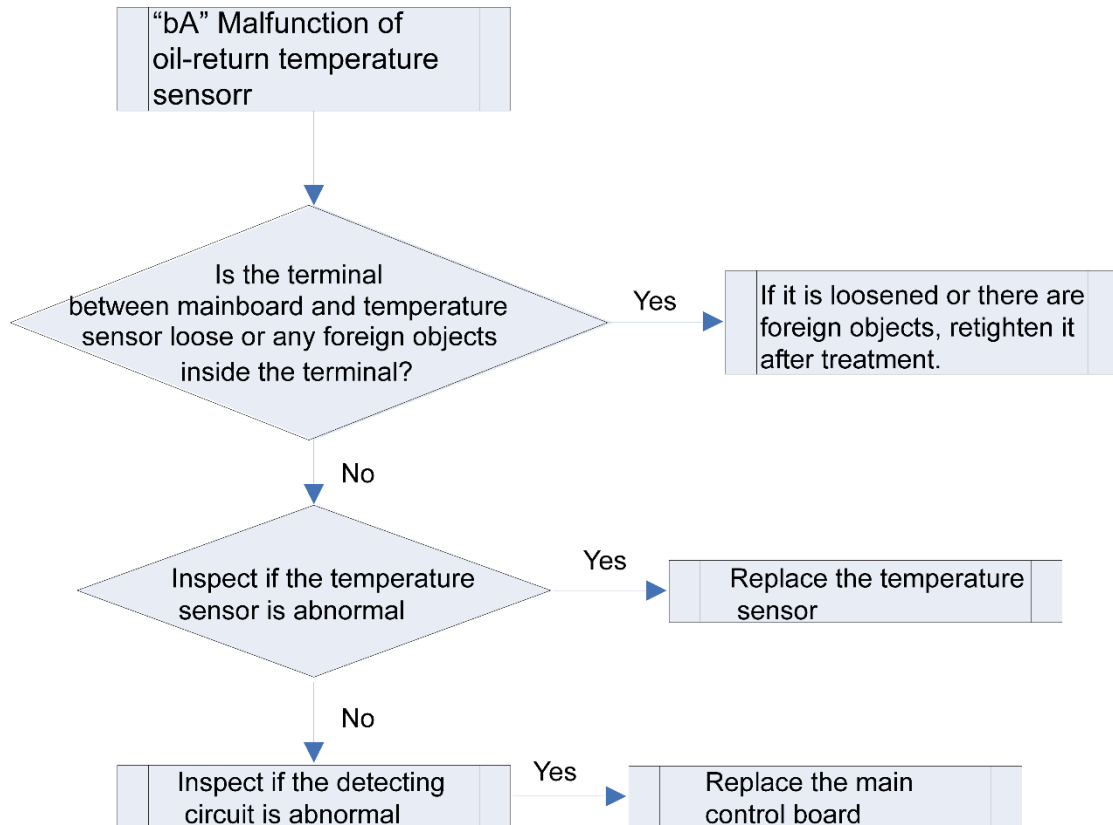

**Troubleshooting:**

## 2.3.4.27 “C0” IDU and ODU, IDU wired controller communication error

**Error display:** ODU mainboard, IDU wired controller and IDU receive light board will

**Error judgment condition and method:**

If no communication between ODU and IDU or between IDU and wired controller in continuous 30s, report the error.

**Possible reason:**

- Communication wire is connected improperly or loose
- Communication wire is cut off
- Communication wire is in poor connection
- Connected wired controller quantity or address setting is improper
- Controller is abnormal

**Troubleshooting:**

If C0 isn't displayed on the ODU main control board, please check the network between IDU and wired controller; if ODU main control board, IDU light board and wired controller all report C0, please check the network between ODU and IDU and the network between IDU and wired controller; if only wired controller reports C0, please check the network between IDU and wired controller and the wired controller quantity and address settings.

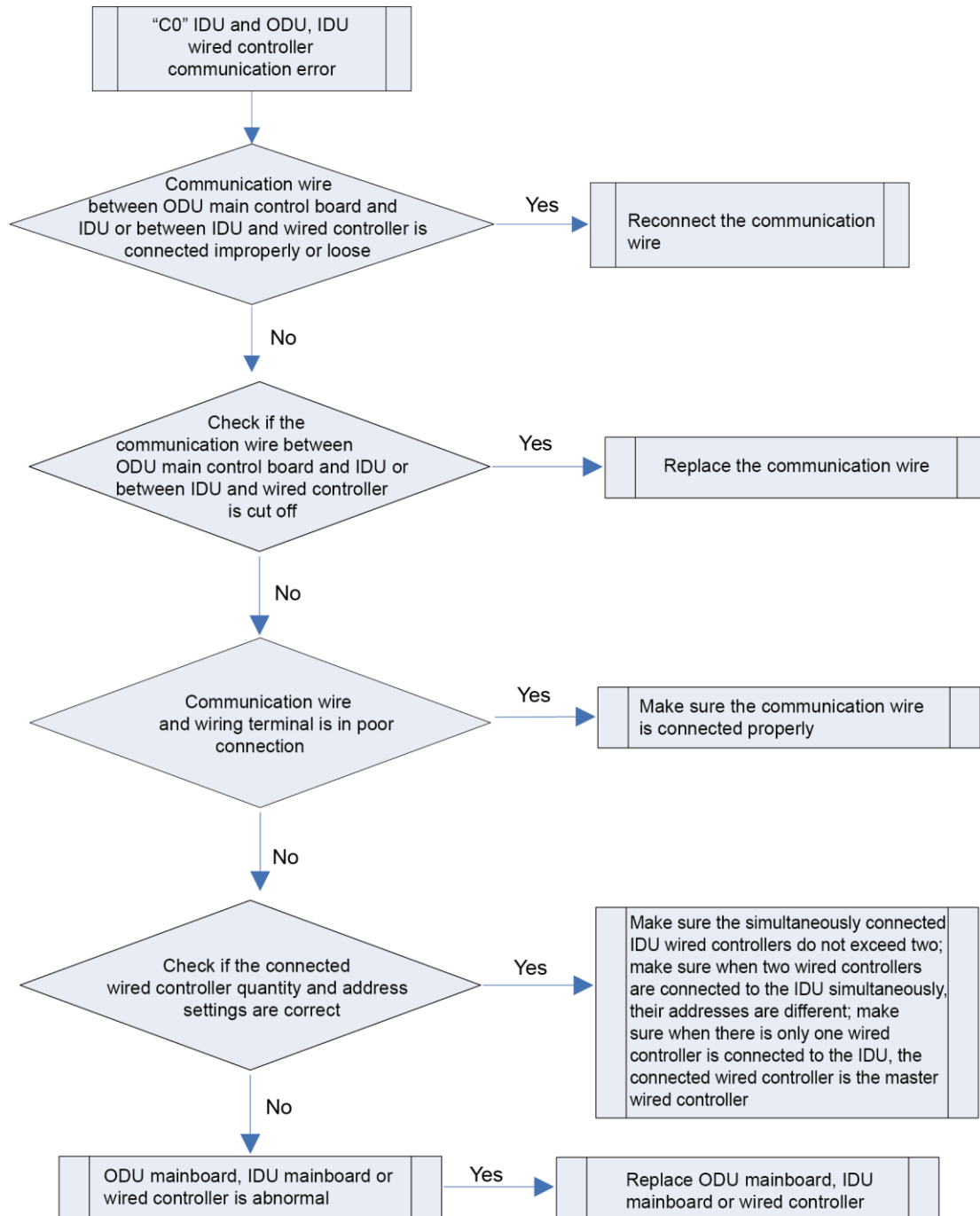

2.3.4.28“C2” main control and inverter compressor drive communication error

**Error display:** ODU mainboard, IDU wired controller and IDU receive light board will



**Error judgment condition and method:**

If ODU hasn't received inverter compressor drive board data in continuous 30s, report the error.

**Possible reason:**

- Communication wire between ODU mainboard inside module and inverter compressor drive board is not connected properly
- Inverter compressor drive board is abnormal
- Mainboard is abnormal

**Troubleshooting:**

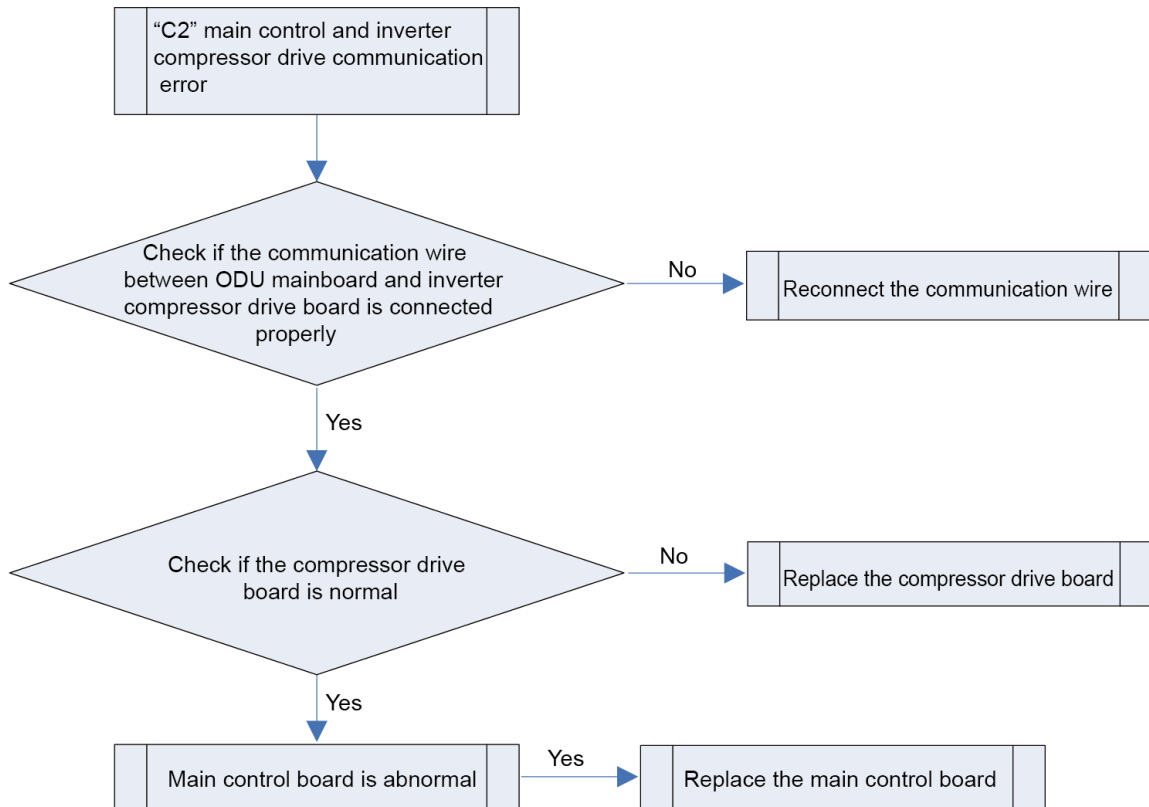

2.3.4.29 “C3” main control and inverter fan drive communication error

**Error display:** ODU mainboard, IDU wired controller and IDU receive light board will



**Error judgment condition and method:**

If ODU hasn't received inverter fan drive board data in continuous 30s, report the error.

**Possible reason:**

- Communication wire between ODU mainboard inside module and inverter fan drive board is not connected properly
- Inverter fan drive board is abnormal
- Mainboard is abnormal

**Troubleshooting:**

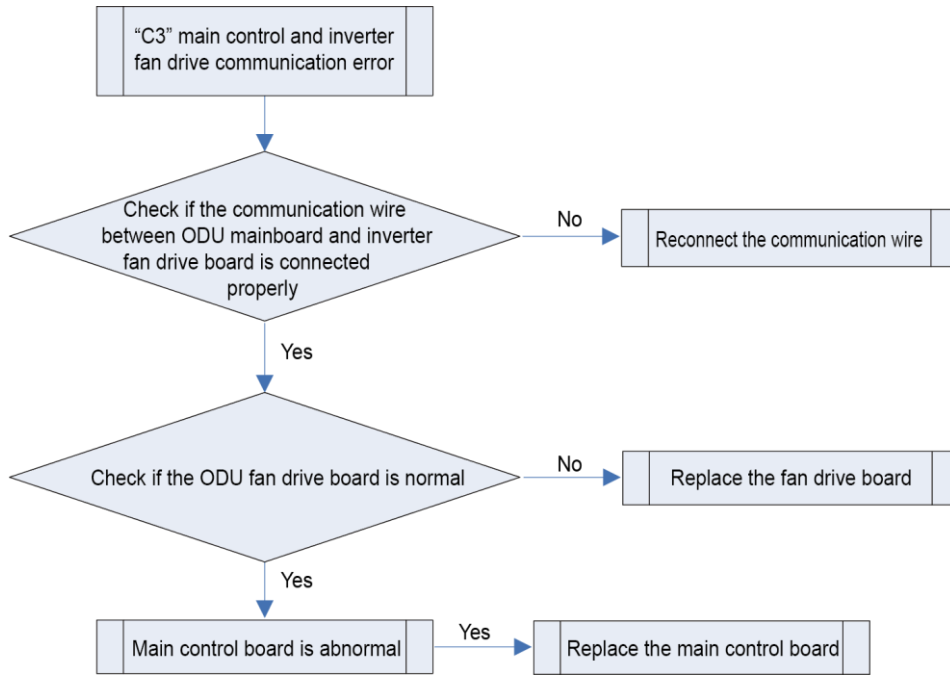

2.3.4.30 “C4” IDU missing error

**Error display:** ODU mainboard, IDU wired controller and IDU receive light board will



**Error judgment condition and method:**

If ODU hasn't received inverter fan drive board data in continuous 30s, report the error.

**Possible reason:**

- Communication wire is in poor connection
- Power supply of IDU is cut off
- IDU mainboard is abnormal

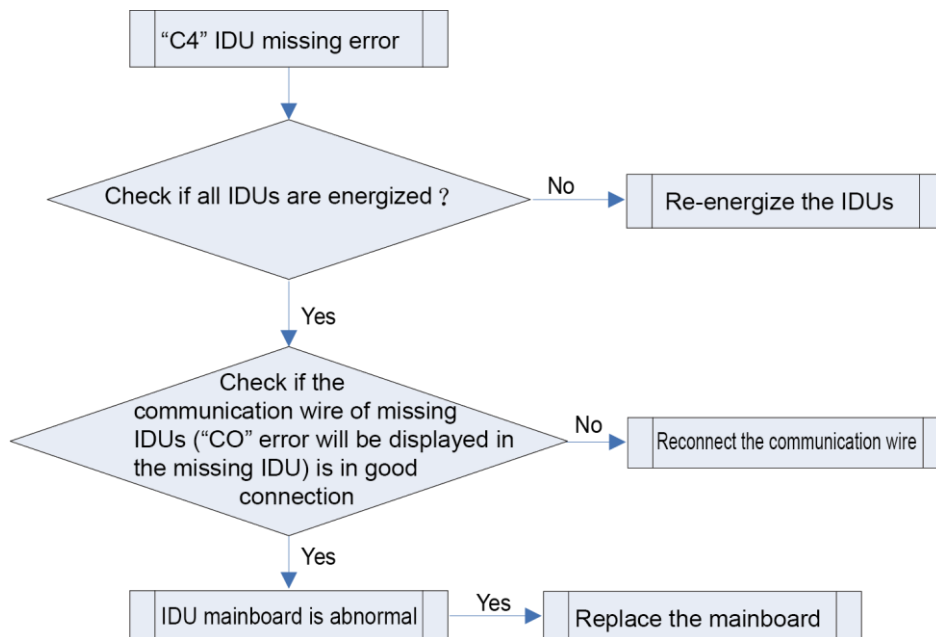

### 2.3.4.31 “C5” IDU project code conflict

**Error display:** debugging software and long-distance monitoring software will display



**Error judgment condition and method:**

Check IDU project code. All IDUs with the same project codes will report this error. But this error will be displayed and require elimination only when debugging software, central controller and long-distance monitoring software are connected.

When it is not in central control, it will not affect the operation of this indoor unit and the whole unit even if there is project code conflict.

**Possible reason:**

- Project code settings are identical;
- IDU mainboard is replaced by the mainboard that is ever used in other system;

**Troubleshooting:**

You can reset the conflict IDU project codes through the following ways:

Reset project codes through debugging software;

Reset project codes through wired controller;

Reset project codes through debugging remote controller;

Reset this mainboard through the reset button on IDU mainboard and let the system reallocate the code.

### 2.3.4.32 “C6” Outdoor unit quantity inconsistency warning

**Error display:** ODU mainboard, IDU wired controller and IDU receive light board will

display



**Error judgment condition and method:**

The system detects online outdoor module quantity in real time. When it is detected that current module quantity is inconsistent with the memorized module quantity in debugging, the unit will report this error and stop operation for protection.

**Possible reason:**

- Communication between modules is abnormal;
- Module is not energized;

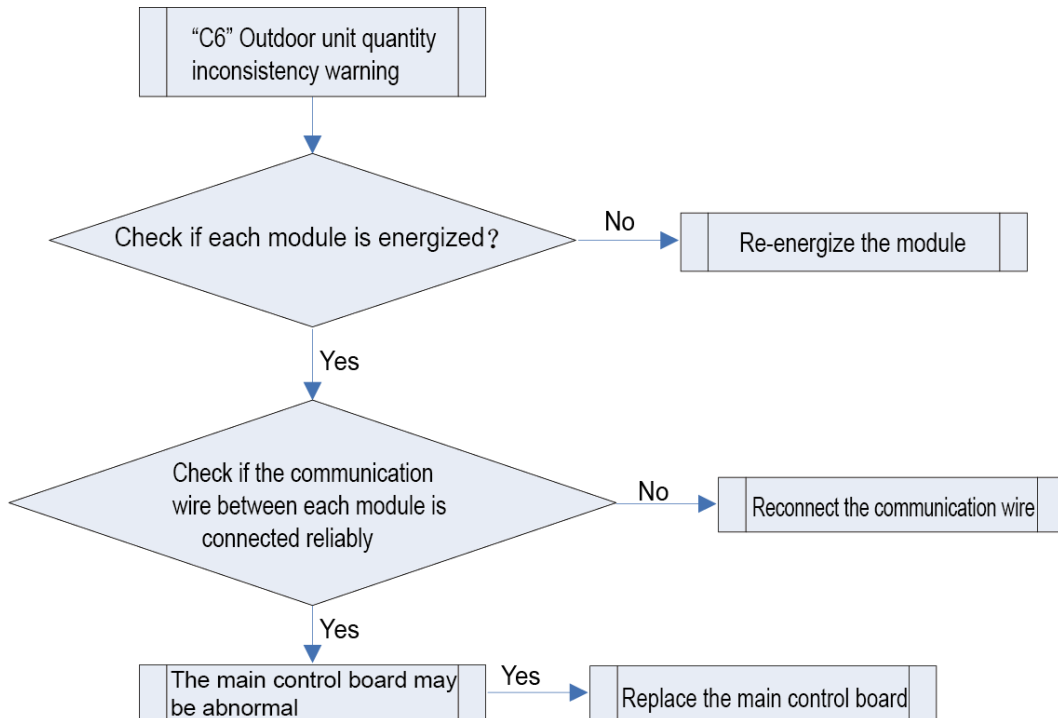
**Troubleshooting:**

## 2.3.4.33 “C8” Compressor emergency operation status.

**Error display:** ODU mainboard will display

**Error judgment condition and method:**

If any compressor in the module is set with emergency operation status, the mainboard will display “C8” to indicate that the system has entered compressor emergency operation status during operation

**Possible reason:** ——

**Troubleshooting:** status code, no troubleshooting.

## 2.3.4.34 “C9” Emergency operation status of fan.

**Error display:** ODU mainboard will display

**Error judgment condition and method:**

If any fan in the module is set with emergency operation status, the mainboard will display “C8” to indicate that the system has entered compressor emergency operation status during operation

**Possible reason:** ——

**Troubleshooting:** status code, no troubleshooting.

## 2.3.4.35 “CA” Emergency operation status of module.

**Error display:** ODU mainboard will display

**Error judgment condition and method:**

If any compressor in the module is set with emergency operation status, the mainboard will display “C8” to indicate that the system has entered compressor emergency operation status during operation

**Possible reason:** ——

**Troubleshooting:** status code, no troubleshooting.

#### 2.3.4.36 “CH” Rated capacity ratio is too high

**Error display:** ODU mainboard, IDU wired controller and IDU receive light board will

display 

**Error judgment condition and method:**

The system detects rated capacity of online IDUs and ODUs. When the ratio between total rated capacity of IDUs and total rated capacity of ODUs is more than 1.35, the unit will limit unit on and report this error.

**Possible reason:**

- Total rated capacity of IDUs is more than 1.35 times of total rated capacity of ODUs;
- Rearrange project design to reduce IDU capacity or increase ODU capacity.

#### 2.3.4.37 “CL” Rated capacity ratio is too low

**Error display:** ODU mainboard, IDU wired controller and IDU receive light board will

display 

**Error judgment condition and method:**

The system detects rated capacity of online IDUs and ODUs. When the ratio between total rated capacity of IDUs and total rated capacity of ODUs is less than 0.5, the unit will limit unit on and report this error.

**Possible reason:**

- Total rated capacity of IDUs is less than 0.5 time of total rated capacity of ODUs;

**Troubleshooting:**

Rearrange project design to increase IDU capacity or decrease ODU capacity.

#### 2.3.4.38 “CC” No master controlling unit error

**Error display:** ODU mainboard, IDU wired controller and IDU receive light board will

display 

**Error judgment condition and method:**

Mainboard detects the DIP switch (SA8) of master controlling unit to judge if it is master controlling unit.

When master controlling unit is not detected in the communication network of multiple modules system, it will report this error.

**Possible reason:**

- DIP switch of master controlling unit is abnormal; there is no master controlling unit in the network
- Communication wire of network is abnormal, so that the master controlling unit is not connected to

the network

- Detecting circuit is abnormal

**Troubleshooting:**

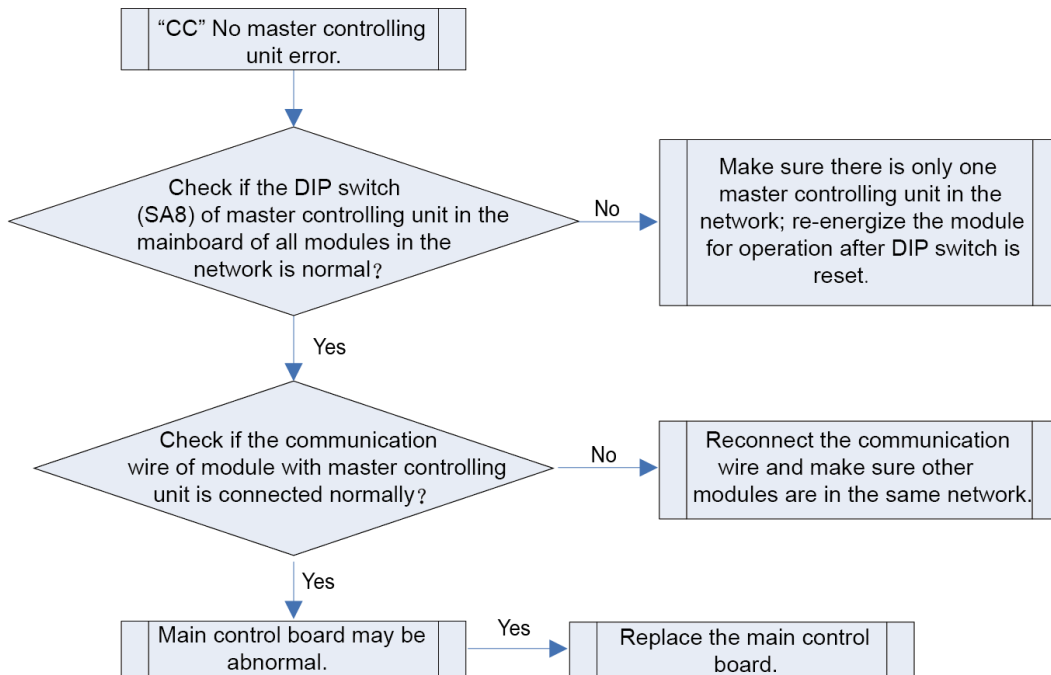

2.3.4.39 “CF” Multiple master controlling units error

**Error display:** ODU mainboard, IDU wired controller and IDU receive light board will



**Error judgment condition and method:**

Mainboard detects the DIP switch (SA8) of master controlling unit to judge if it is master controlling unit. When multiple master controlling units are detected in the communication network of multiple modules system, it will report this error.

**Possible reason:**

- DIP switch of master controlling unit is abnormal; there are multiple master controlling units in the network

- Detecting circuit is abnormal

**Troubleshooting:**

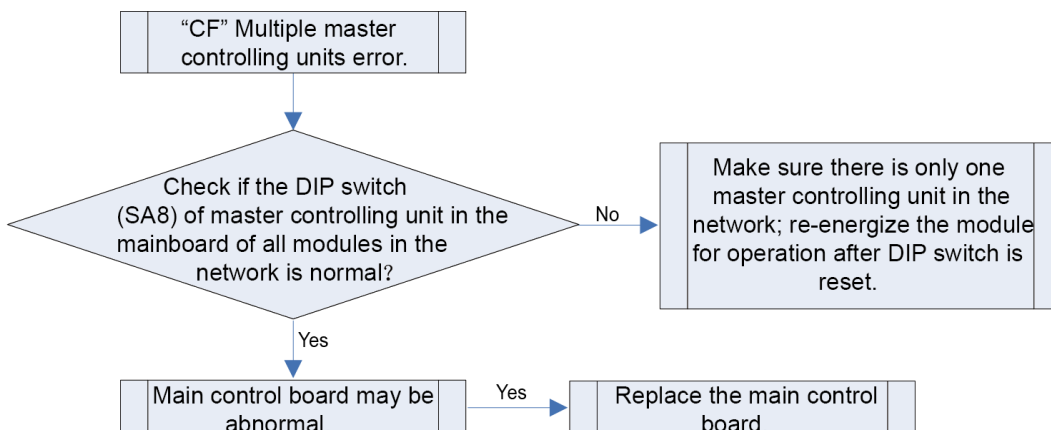



#### 2.3.4.40 “CJ” System address code conflict

**Error display:** ODU mainboard, IDU wired controller and IDU receive light board will

display 

**Error judgment condition and method:**

When multiple refrigerant system is connected through CAN2 network of unit mainboard, it is allowable to have only one master system in this network.

When the system address DIP switch (SA2) of master controlling unit in two or more systems are detected as the master system DIP switch simultaneously, that is SA2 DIP switch is “00000”, it will report multiple master systems error.

**Possible reason:**

- When the system address DIP switch (SA2) of master controlling unit in two or more systems are set as the master system DIP switch, the SA2 DIP switch of master controlling unit in only one system shall keep as “00000”. The SA2 DIP switch of master controlling unit in other systems shall be set in different codes.

- DIP switch is abnormal or mainboard is abnormal.

**Troubleshooting:**

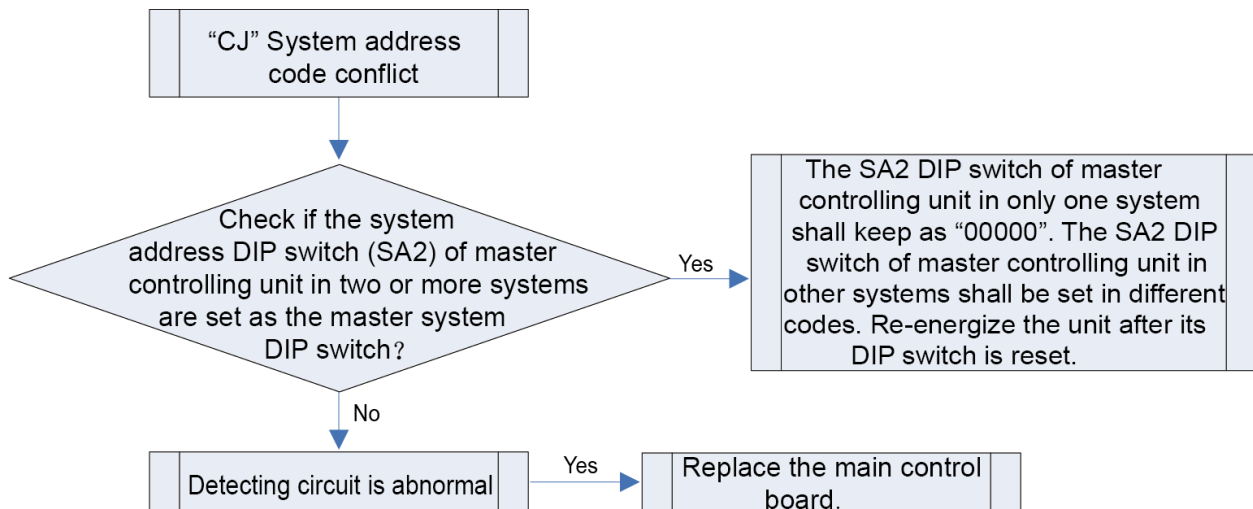

#### 2.3.4.41 “CP” Multiple master wired controller error

**Error display:** ODU mainboard, IDU wired controller and IDU receive light board will

display 

**Error judgment condition and method:**

There are two or more wired controllers in one HBS network are set as the master wired controller.

**Possible reason:**

When two (or more) wired controllers control one or several IDUs simultaneously, the two (or more) wired controller are master wired controller.

**Troubleshooting:**

Make sure there are two wired controllers in maximum to control one or several IDUs; when two wired controllers control one or several IDUs, enter wired controller parameter setting (P13) to set the address of one wired controller as 02, that is slave wired controller.

## 2.3.4.42 “Cb” IP address allocation overflow

**Error display:** ODU mainboard, IDU wired controller and IDU receive light board will display 

**Error judgment condition and method:**

If the quantity of address that ODU allocates to other ODU modules exceeds 4, the system will report IP address allocation overflow.

If the quantity of address that ODU allocates to IDUs exceeds 80, the system will report IP address allocation overflow.

**Possible reason:**

- ODU quantity in the system exceeds 4
- IDU quantity in the system exceeds 80
- After replacing the IDU and ODU mainboard, ODU is not de-energized.

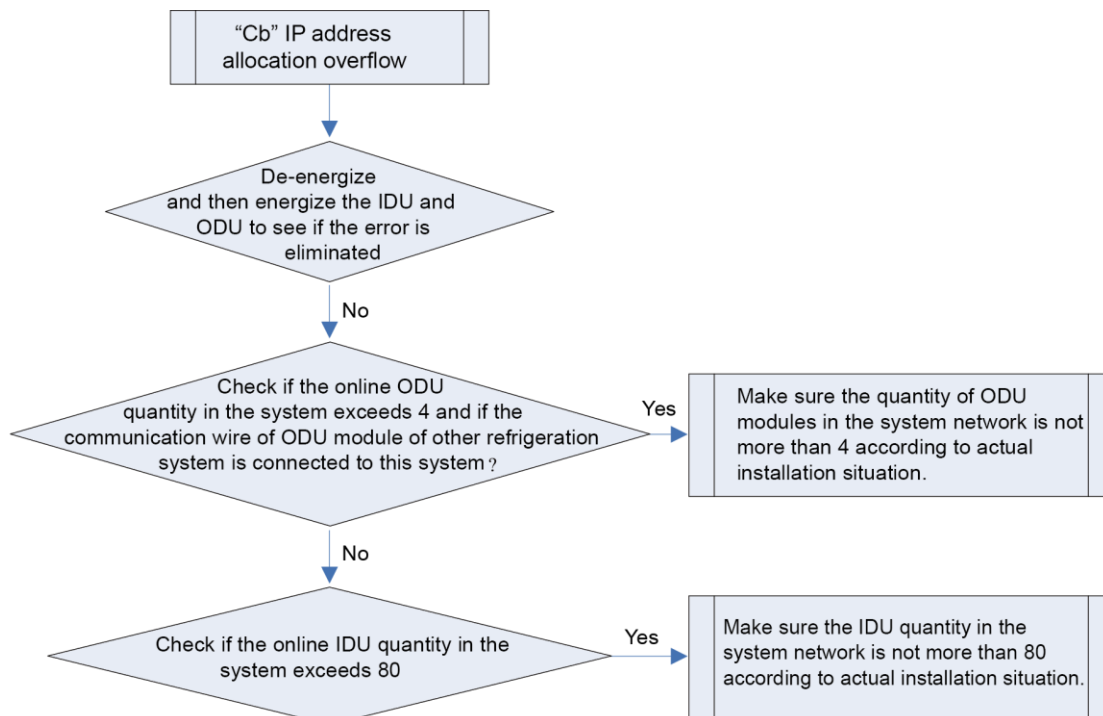
**Troubleshooting:**

## 2.3.4.43 “d1” Indoor circuit board error

**Error display:** IDU wired controller and IDU receive light board will display 

**Error judgment condition and method:**

Check if the reading of address chip and memory chip of IDU mainboard is normal. If the data of address chip and memory chip cannot be read, it is abnormal

**Possible reason:**

- Address chip is abnormal
- Memory chip is abnormal. Replace main control board directly

**Troubleshooting:**

Replace main control board directly

## 2.3.2.44 “d3” Ambient temperature sensor error

**Error display:** IDU wired controller and IDU receive light board will display

**Error judgment condition and method:**

Sample the AD value of temperature sensor through temperature sensor detecting circuit and judge the range of AD value, If the sampling AD value exceeds upper limit and lower limit in 5 seconds continuously, report the error

**Possible reason:**

- Poor contact between ambient temperature sensor and terminal in mainboard interface
- Ambient temperature sensor is abnormal
- Detecting circuit is abnormal

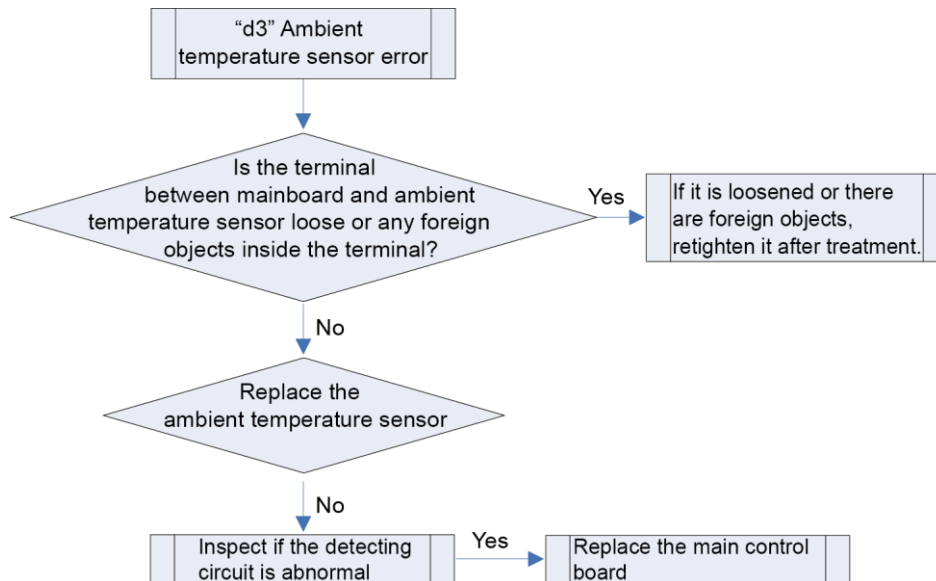
**Troubleshooting:**

## 2.3.4.45 “d4” Inlet pipe temperature sensor error

**Error display:** IDU wired controller and IDU receive light board will display

**Error judgment condition and method:**

Sample the AD value of temperature sensor through temperature sensor detecting circuit and judge the range of AD value. If the sampling AD value exceeds upper limit and lower limit in 5 seconds continuously, report the error

**Possible reason:**

- Poor contact between inlet pipe temperature sensor and terminal in mainboard interface

- Inlet pipe temperature sensor is abnormal
- Detecting circuit is abnormal

**Troubleshooting:**

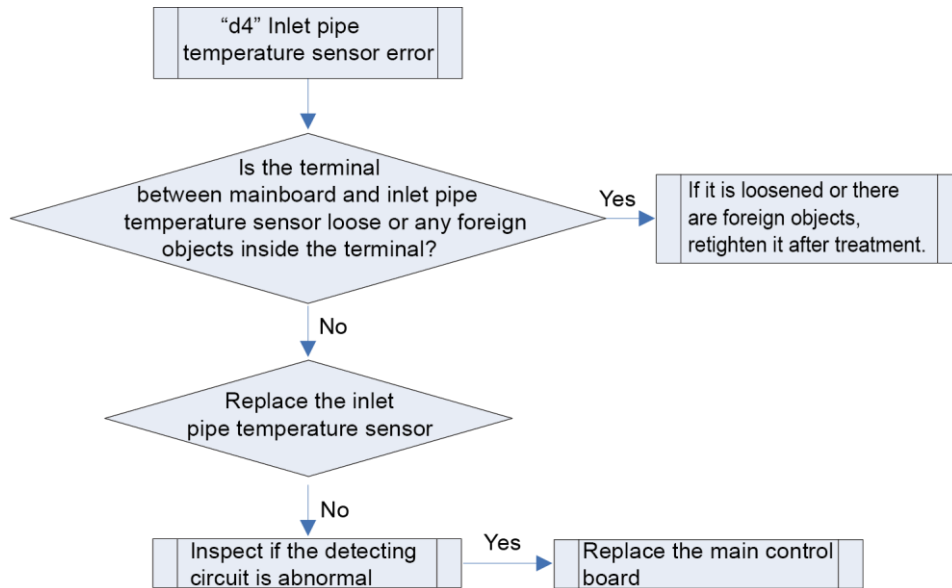

2.3.4.46 “d6” Outlet pipe temperature sensor error

**Error display:** IDU wired controller and IDU receive light board will display



**Error judgment condition and method:**

Sample the AD value of temperature sensor through temperature sensor detecting circuit and judge the range of AD value. If the sampling AD value exceeds upper limit and lower limit in 5 seconds continuously, report the error

**Possible reason:**

- Poor contact between outlet pipe temperature sensor and terminal in mainboard interface
- Outlet pipe temperature sensor is abnormal
- Detecting circuit is abnormal

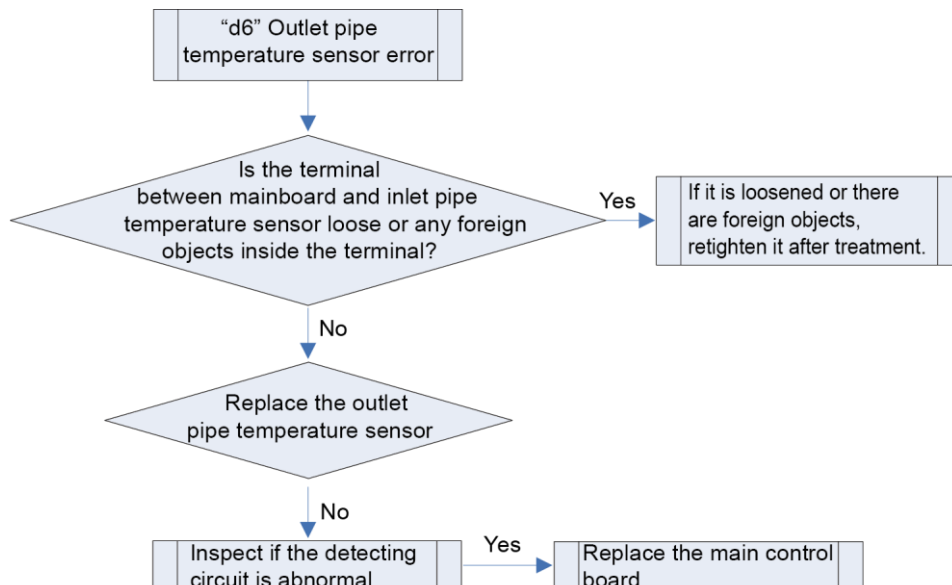

## 2.3.4.47 “d7” Humidity sensor error

**Error display:** IDU wired controller and IDU receive light board will display



**Error judgment condition and method:**

Sample the AD value of temperature sensor through temperature sensor detecting circuit and judge the range of AD value. If the sampling AD value exceeds upper limit and lower limit in 5 seconds continuously, report the error

**Possible reason:**

- Poor contact between humidity sensor and terminal in mainboard interface
- Humidity sensor is abnormal
- Detecting circuit is abnormal

**Troubleshooting:**

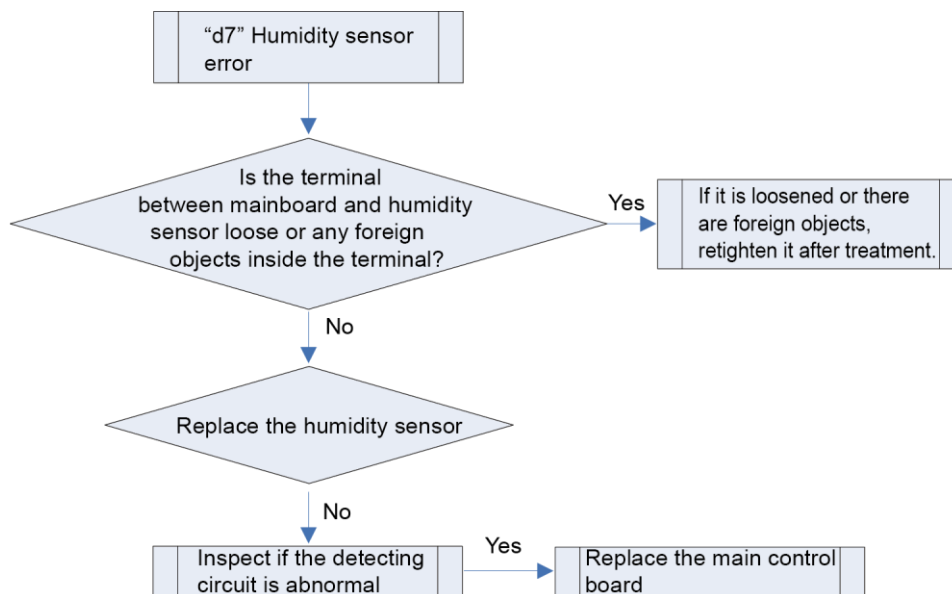

## 2.3.4.48 “d9” Jumper cap error

**Error display:** IDU wired controller and IDU receive light board will display



**Error judgment condition and method:**

**Possible reason:**

If jumper cap model doesn't match with mainboard, report the error

- Jumper cap is not installed
- Jumper cap model is wrong
- Detecting circuit is abnormal

**Troubleshooting:**

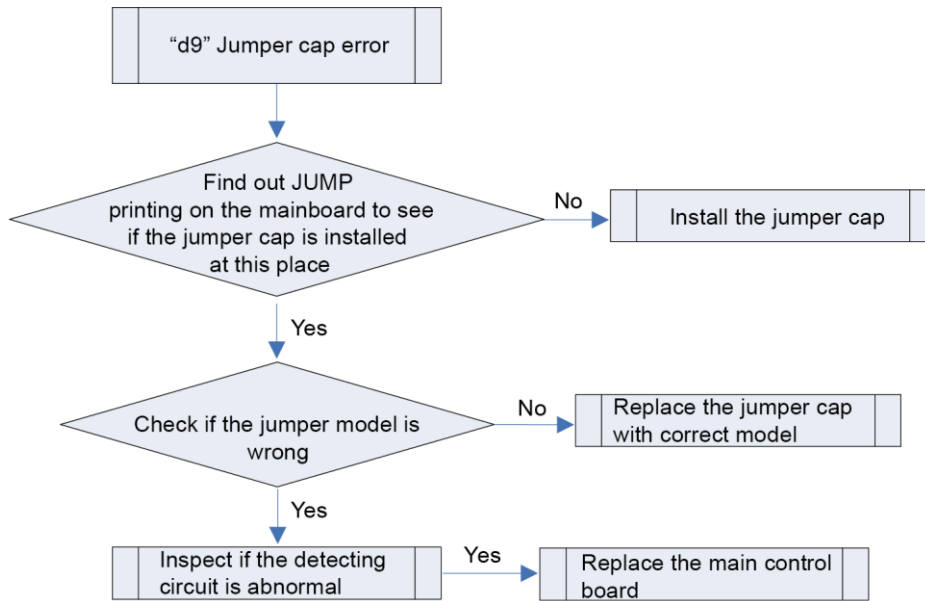

2.3.4.49 “dA” IDU network address error

**Error display:** IDU wired controller and IDU receive light board will display



**Error judgment condition and method:**

Through testing the IDU address chip and IP address, if address chip cannot be read, IDU IP is 0 or IP is in conflict, report the error.

**Possible reason:**

- ODU allocated address is wrong
- IDU treatment is wrong
- Address chip is abnormal

**Troubleshooting:**

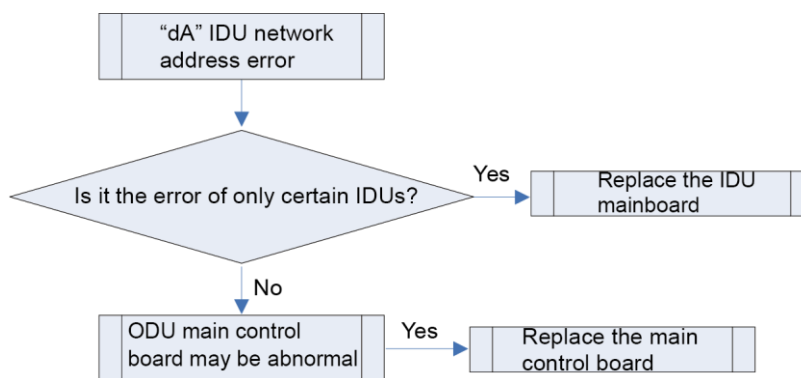

2.3.4.50 “dH” wired controller circuit board error

**Error display:** IDU wired controller and IDU receive light board will display



**Error judgment condition and method:**

Wired controller IIC communication is abnormal

**Possible reason:**

- Communication of wired controller touch button board and display board IIC is abnormal;
- Read and write of wired controller memory chip IIC is abnormal (when memory chip is existed);

**Troubleshooting:**

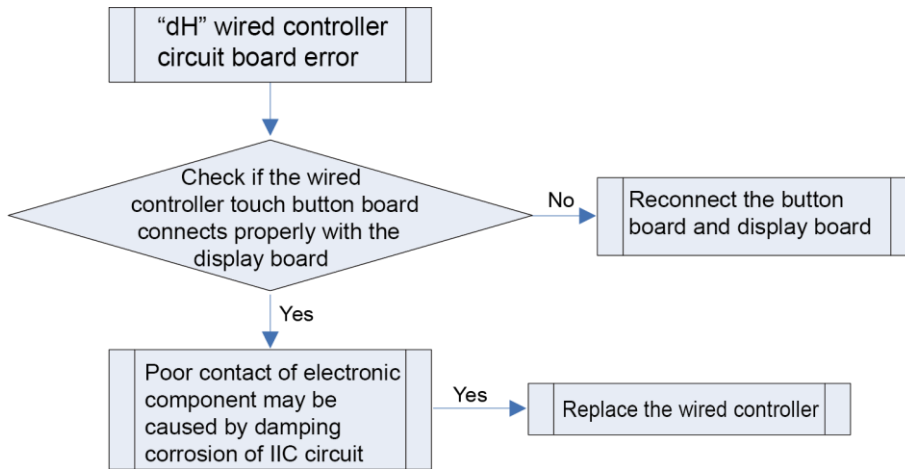

2.3.4.51 “dC” Capacity DIP switch setting error

**Error display:** IDU wired controller and IDU receive light board will display



**Error judgment condition and method:**

If capacity DIP switch is set to the wrong position, report the error.

**Possible reason:**

- Capacity DIP switch is set to the wrong position
- Detecting circuit is abnormal

**Troubleshooting:**

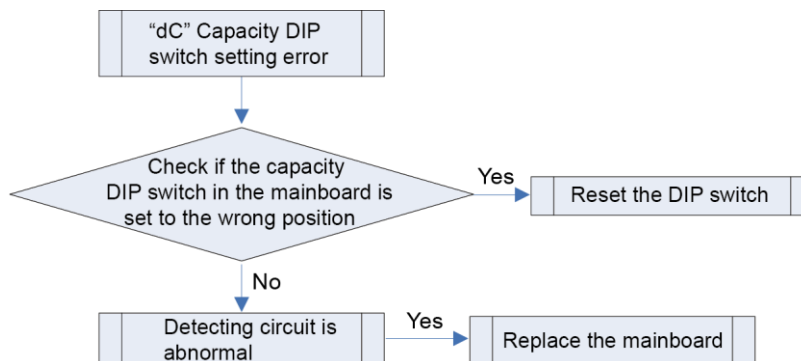

2.3.4.52 “dL” Air outlet temperature sensor error

**Error display:** IDU wired controller and IDU receive light board will display



**Error judgment condition and method:**

Sample the AD value of temperature sensor through temperature sensor detecting circuit and judge the range of AD value. If the sampling AD value exceeds upper limit and lower limit in 5 seconds continuously, report the error

**Possible reason:**

- Poor contact between air outlet temperature sensor and terminal in mainboard interface
- Air outlet temperature sensor is abnormal
- Detecting circuit is abnormal

**Troubleshooting:**

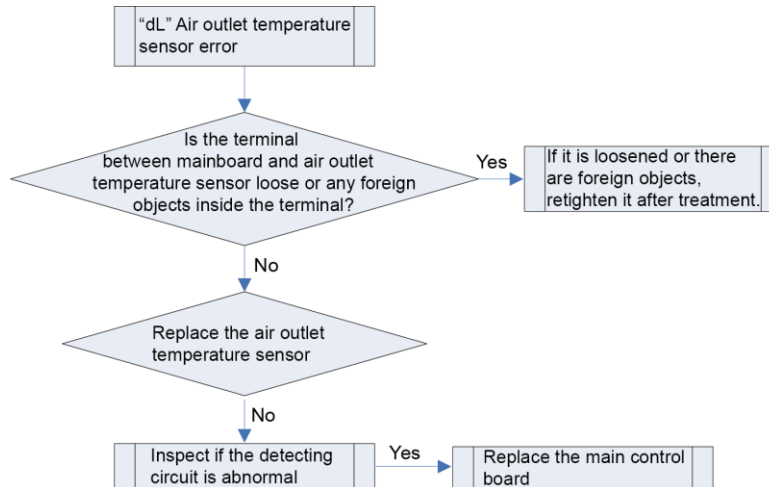

### 2.3.4.53 “db” Project debugging

**Error display:** ODU mainboard, IDU wired controller and IDU receive light board will



**Error judgment condition and method:**

This is a status code of project debugging, not a error code. When IDU or ODU displays this code, it means the unit is under debugging status and the IDU cannot be operated.

**Troubleshooting:** ——

**Possible reason:** ——

### 2.3.4.54 “E1” High pressure protection

**Error display:** ODU mainboard, IDU wired controller and IDU receive light board will



**Error judgment condition and method:**

Judge through high pressure sensor detecting system real-time high pressure or action of high pressure switch. If the sensor detects that high pressure is bigger than 65℃ or high pressure switch is cut off, it is judged that high pressure is too high and the system stops operation for protection.

**Possible reason:**

- Cut-off valve of ODU is not fully opened;
- High pressure sensor is abnormal;
- High pressure switch is abnormal;
- Outdoor or indoor fan is not working properly;
- IDU filter or air duct is blocked (heating mode);
- Ambient temperature is too high;



- Refrigerant charging amount is too much;
- System pipeline is blocked;

**Troubleshooting:**

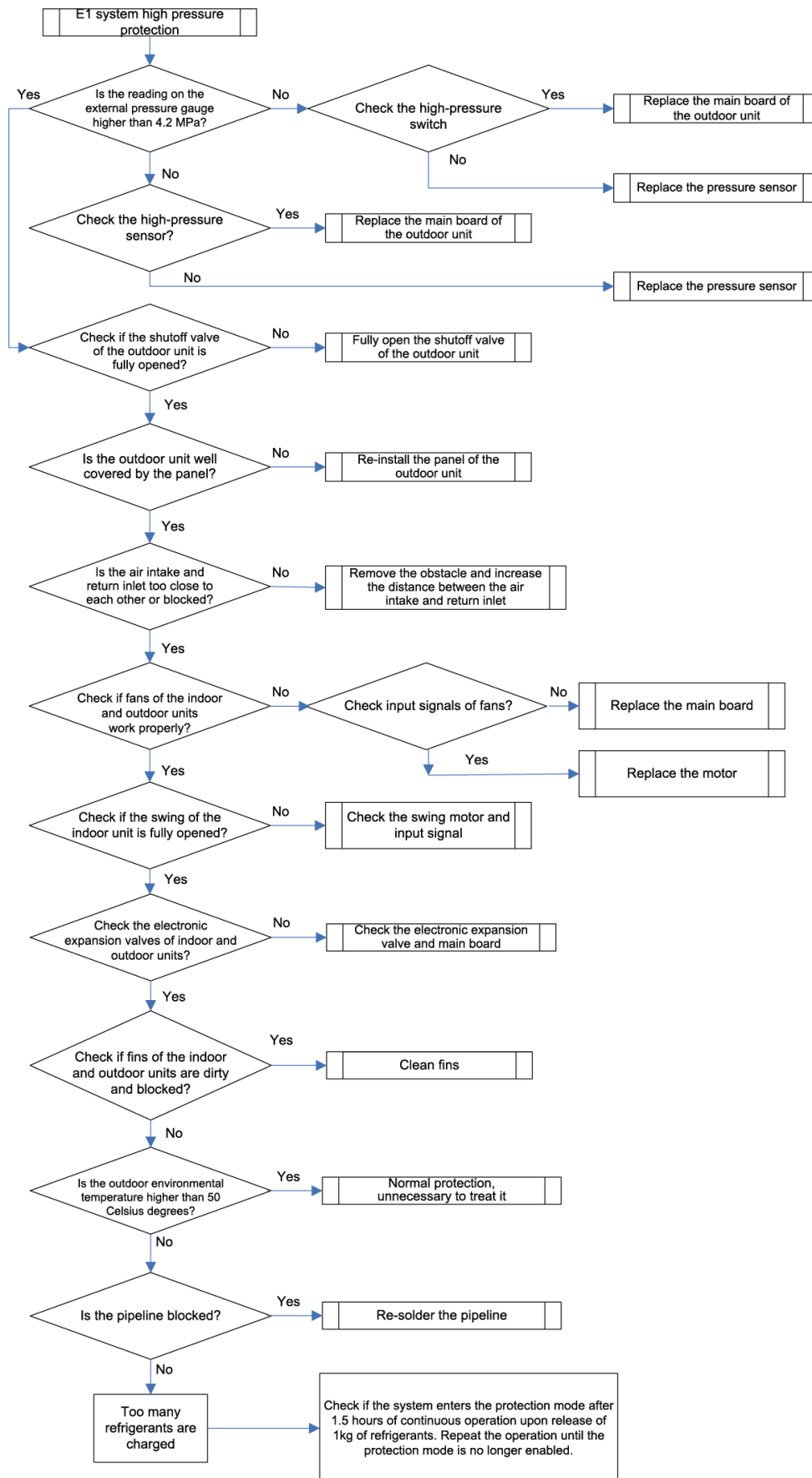

2.3.4.55 “E2” Compressor low discharge temperature protection

**Error display:** ODU mainboard, IDU wired controller and IDU receive light board will



**Error judgment condition and method:**

Test the compressor discharge temperature and high pressure value. If the difference between discharge temperature and high pressure value is lower than 10°C, the unit will stop for protection.

**Possible reason:**

- Exhaust temperature sensor failure
- In cooling mode, The IDU's electronic expansion valve is not working properly
- In heating mode, The ODU's electronic expansion valve is not working properly
- Too much refrigerant

**Troubleshooting:**

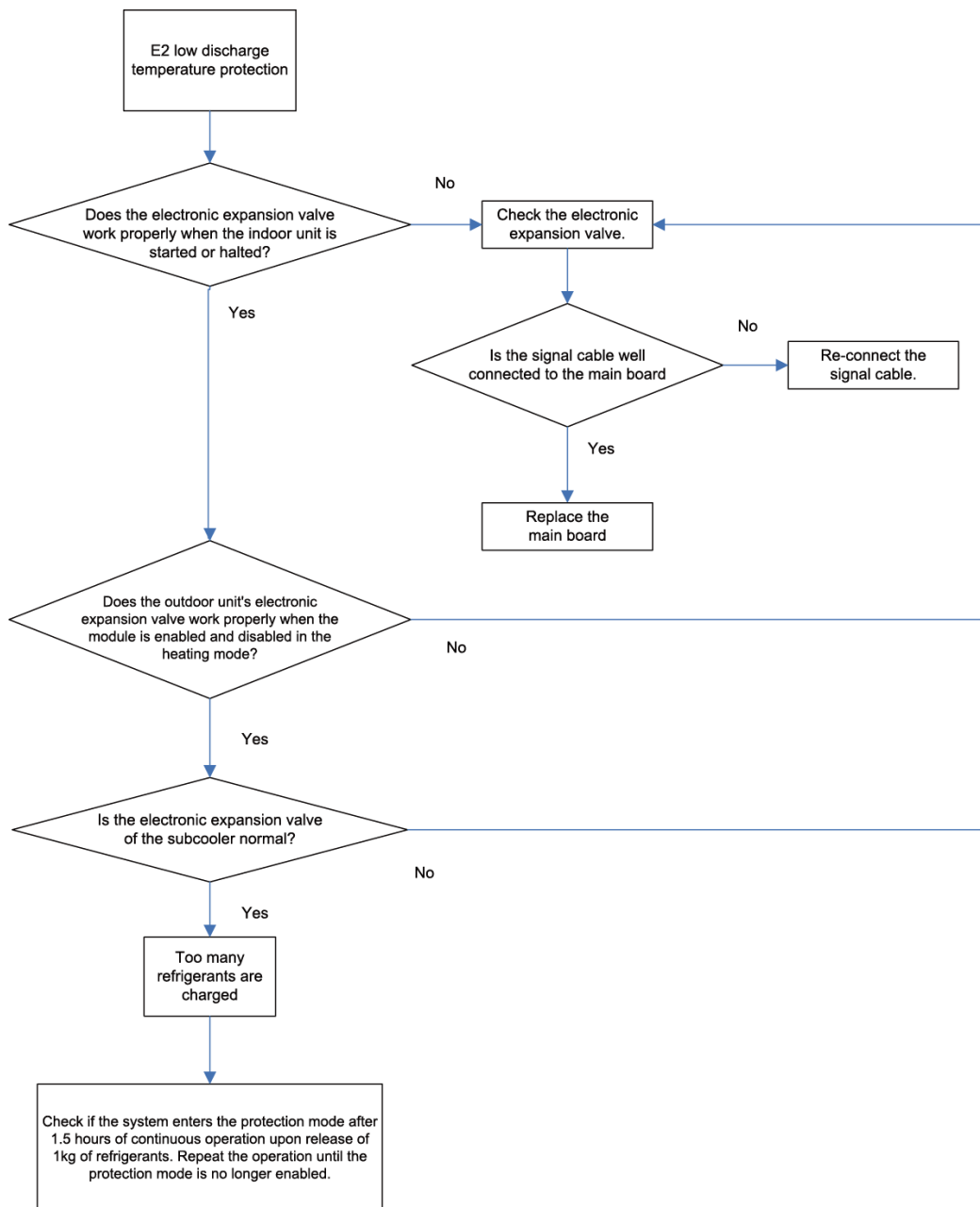

### 2.3.4.56 “E3” System low pressure protection

**Error display:** ODU mainboard, IDU wired controller and IDU receive light board will

display 

**Error judgment condition and method:**

Test compressor suction pressure through low pressure sensor. When pressure value is lower than  $-41^{\circ}\text{C}$ , the unit will stop for protection.

**Possible reason:**

- Cut-off valve of ODU is not fully opened;
- Low pressure sensor is abnormal;
- Outdoor or indoor fan is not working properly;
- IDU filter or air duct is blocked (cooling mode);
- Ambient temperature is too low;
- Refrigerant charging amount is insufficient;
- System pipeline is blocked;

**Troubleshooting:**

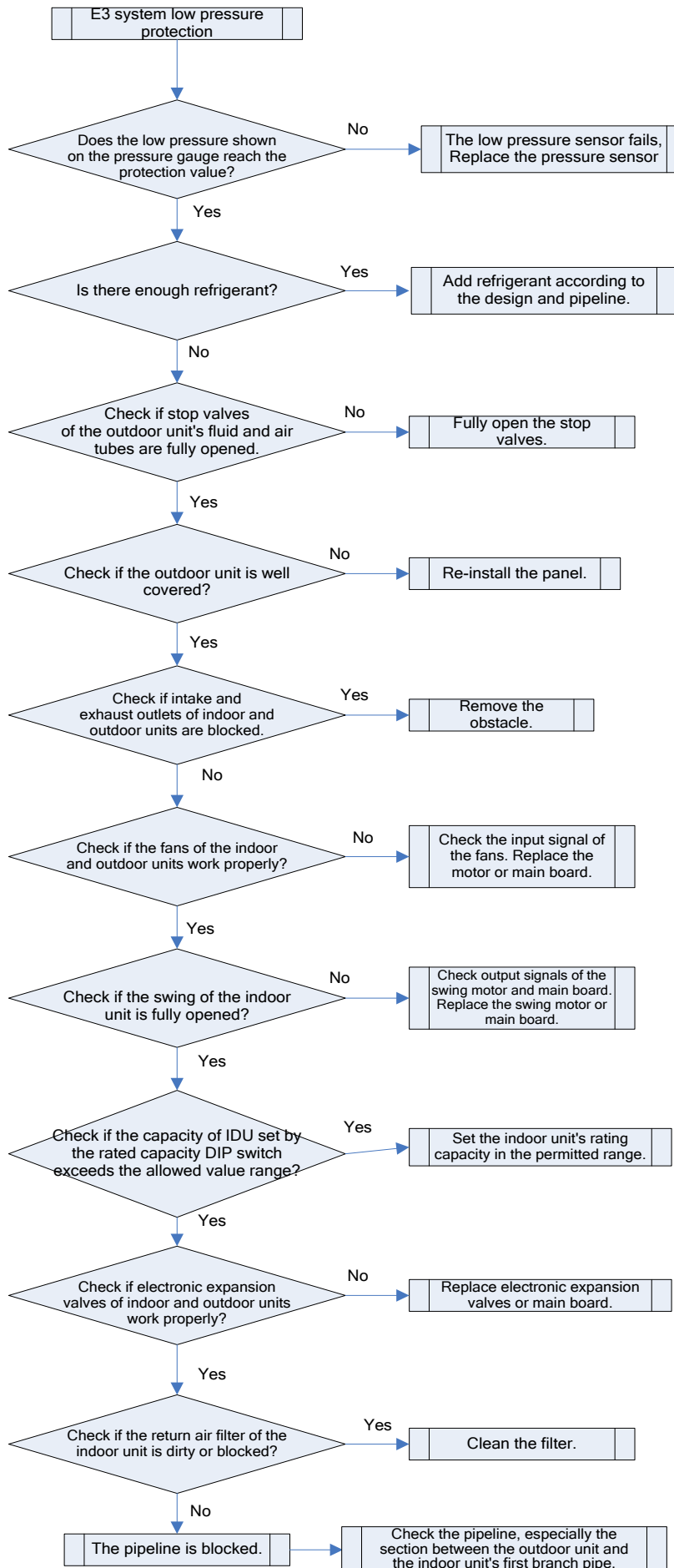

#### 2.3.4.57 “E4” Compressor high discharge temperature protection

**Error display:** ODU mainboard, IDU wired controller and IDU receive light board will

display 

**Error judgment condition and method:**

Test the compressor discharge temperature through compressor discharge pipe and shell top temperature sensor. If the tested temperature value is higher than 118°C, the unit will stop for protection.

**Possible reason:**

- Cut-off valve of ODU is not fully opened;
- Electronic expansion valve is abnormal;
- Outdoor or indoor fan is not working properly;
- IDU filter or air duct is blocked (cooling mode);
- Ambient temperature exceeds allowable operation range;
- Refrigerant charging amount is insufficient;
- System pipeline is blocked;

**Troubleshooting:**

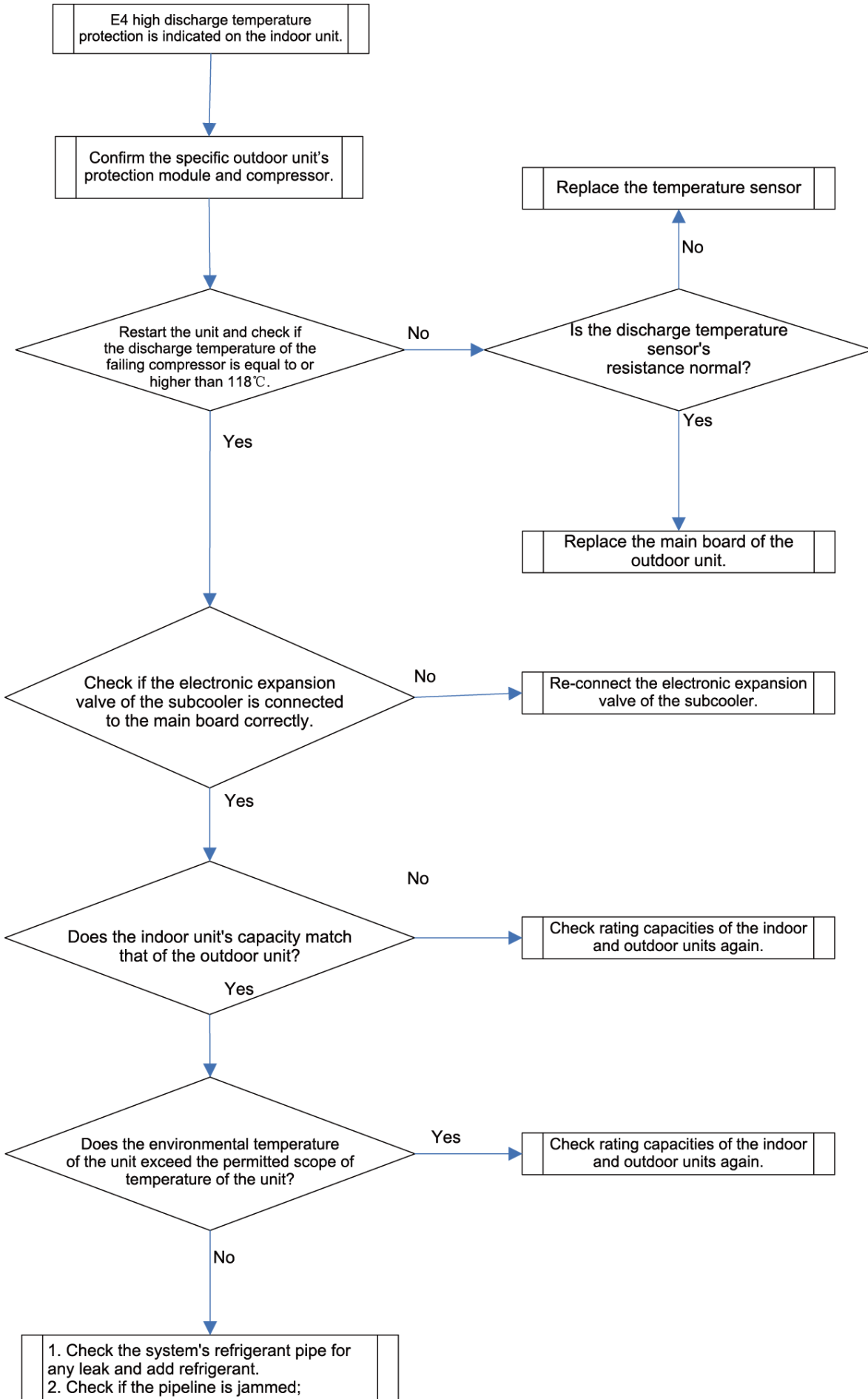

### 2.3.4.58 “F0” ODU mainboard error

**Error display:** ODU mainboard, IDU wired controller and IDU receive light board will

display 

**Error judgment condition and method:**

Check if the reading of address chip, memory chip and clock chip of ODU mainboard is normal. If the data of address chip, memory chip and clock chip cannot be read, it is abnormal.

**Possible reason:**

- Address chip is abnormal
- Memory chip is abnormal
- Clock chip is abnormal

**Troubleshooting:**

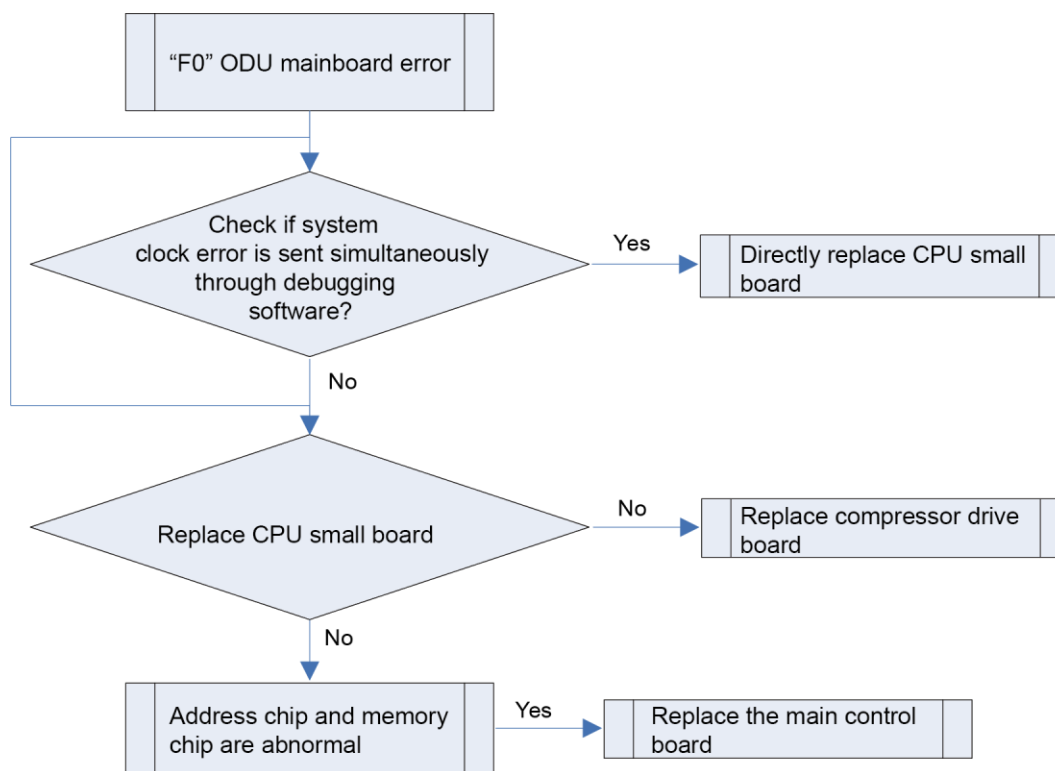

### 2.3.4.59 “F1” High pressure sensor error

**Error display:** ODU mainboard, IDU wired controller and IDU receive light board will

display 

**Error judgment condition and method:**

Sample the AD value of high pressure sensor through sensor detecting circuit and judge the range of AD value; if the sampled AD value exceeds upper limit and lower limit in 30 seconds continuously, report the error.

**Possible reason:**

- Poor contact between high pressure sensor and terminal in mainboard interface
- Poor contact between high pressure sensor and pressure detection position of unit

- High pressure sensor is abnormal
- Detecting circuit of sensor is abnormal

#### Troubleshooting:

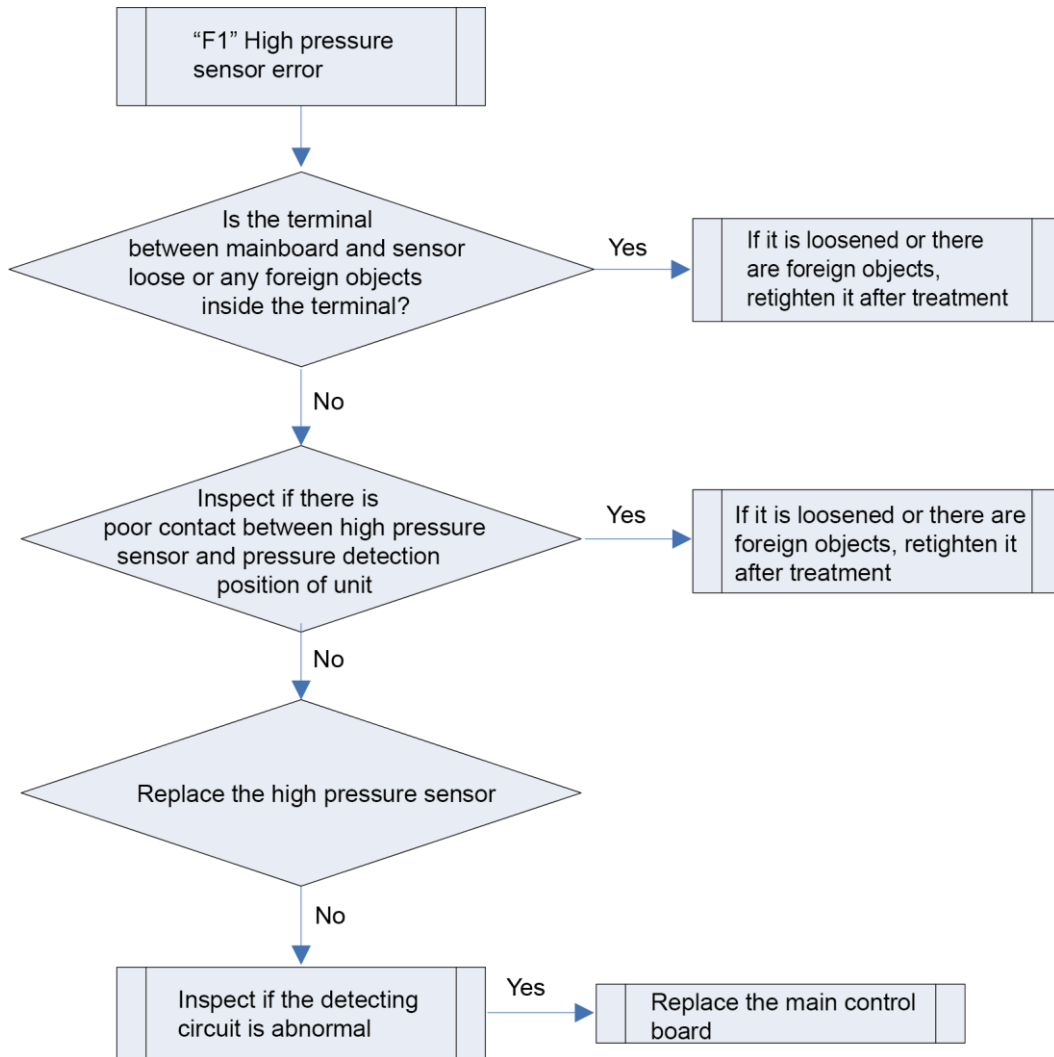

#### 2.3.4.60 "F3" Low pressure sensor error

**Error display:** ODU mainboard, IDU wired controller and IDU receive light board will

display 

#### **Error judgment condition and method:**

Sample the AD value of low pressure sensor through sensor detecting circuit and judge the range of AD value; if the sampled AD value exceeds upper limit and lower limit in 30 seconds continuously, report the error.

#### **Possible reason:**

- Poor contact between low pressure sensor and terminal in mainboard interface
- Poor contact between low pressure sensor and pressure detection position of unit
- low pressure sensor is abnormal
- Detecting circuit of sensor is abnormal



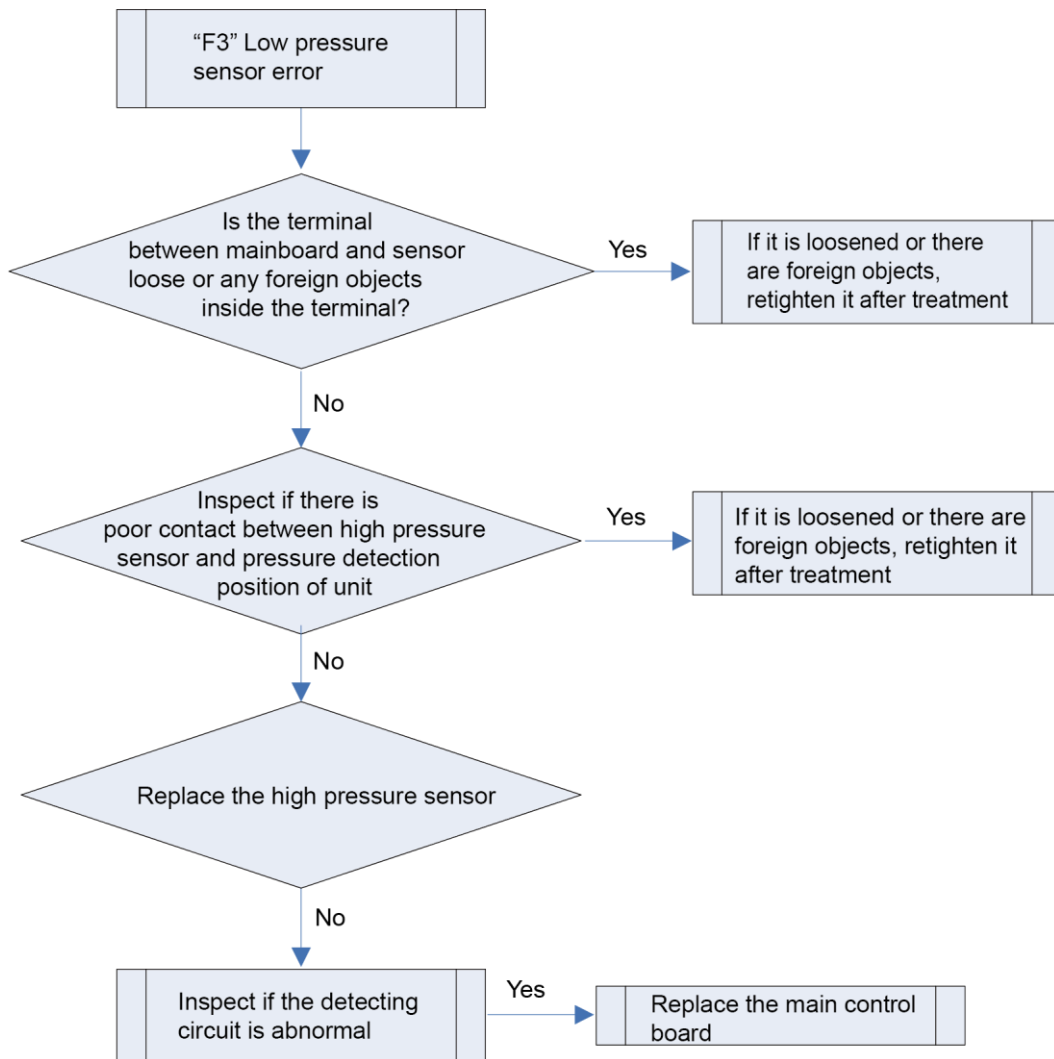

#### 2.3.4.61 "F5" Compressor 1 discharge temperature sensor error

**Error display:** ODU mainboard, IDU wired controller and IDU receive light board will

display 

**Error judgment condition and method:**

Sample the AD value of temperature sensors through temperature sensors circuit and judge the range of AD value; if the sampled AD value exceeds upper limit and lower limit in 30 seconds continuously, report the error.

**Possible reason:**

- Poor contact between discharge temperature sensor and terminal in mainboard interface
- Discharge temperature sensor is abnormal
- Detecting circuit is abnormal

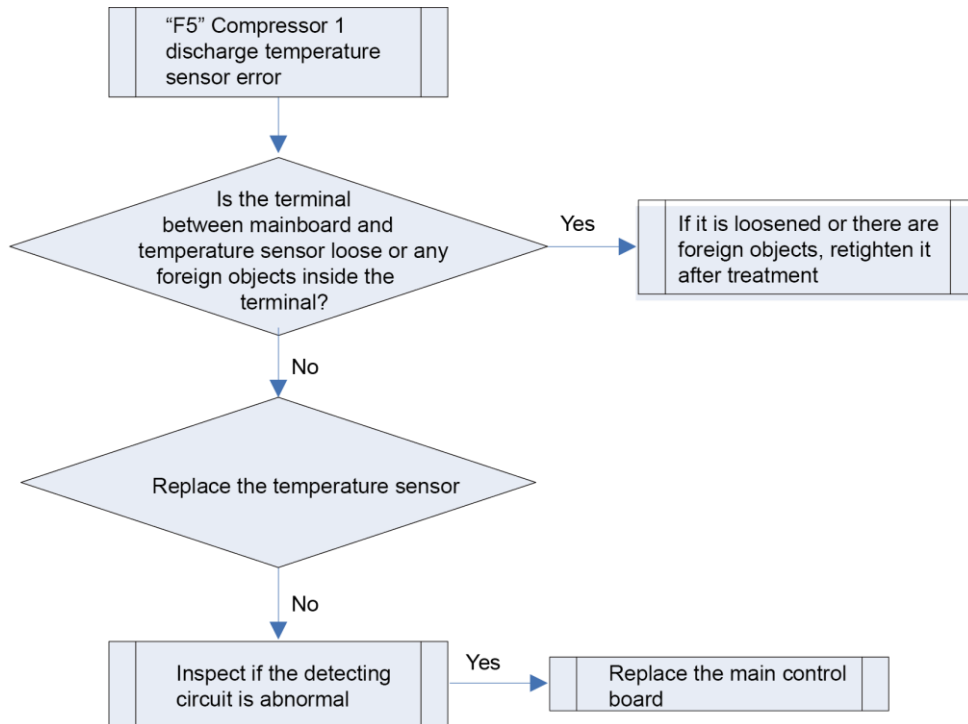
**Troubleshooting:**

## 2.3.4.62 “F6” Compressor 2 discharge temperature sensor error

**Error display:** ODU mainboard, IDU wired controller and IDU receive light board will

display 

**Error judgment condition and method:**

Sample the AD value of temperature sensors through temperature sensors circuit and judge the range of AD value; if the sampled AD value exceeds upper limit and lower limit in 30 seconds continuously, report the error.

**Possible reason:**

- Poor contact between discharge temperature sensor and terminal in mainboard interface
- Discharge temperature sensor is abnormal
- Detecting circuit is abnormal

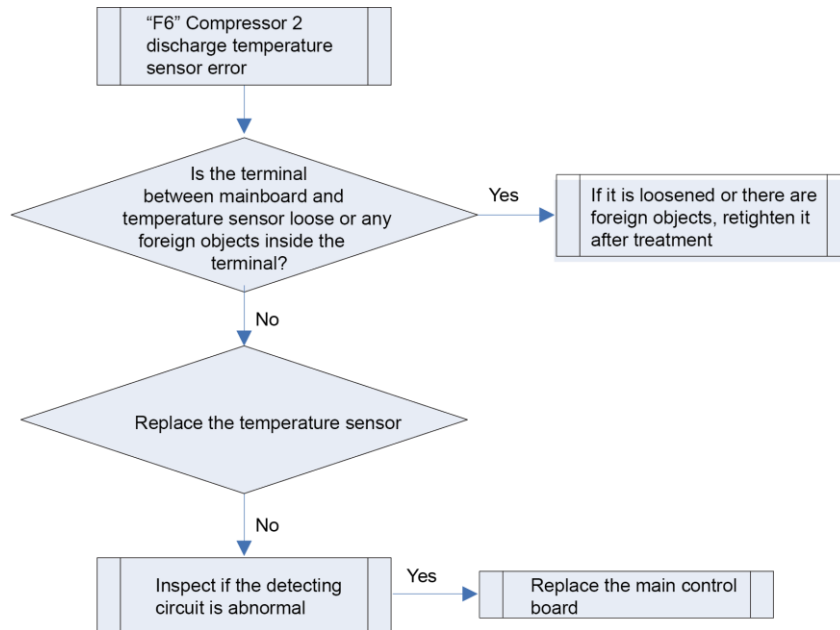
**Troubleshooting:**

## 2.3.4.63 "F7" Compressor 3 discharge temperature sensor error

**Error display:** ODU mainboard, IDU wired controller and IDU receive light board will

display 

**Error judgment condition and method:**

Sample the AD value of temperature sensors through temperature sensors circuit and judge the range of AD value; if the sampled AD value exceeds upper limit and lower limit in 30 seconds continuously, report the error.

**Possible reason:**

- Poor contact between discharge temperature sensor and terminal in mainboard interface
- Discharge temperature sensor is abnormal
- Detecting circuit is abnormal

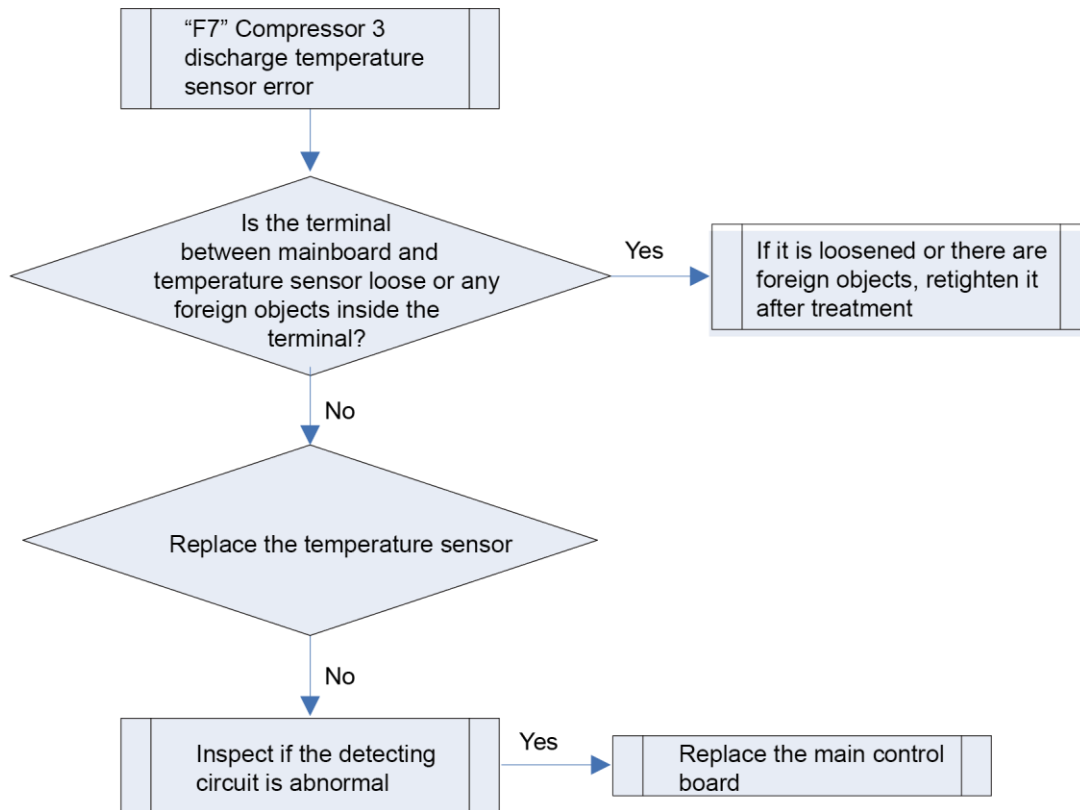
**Troubleshooting:**

## 2.3.4.64 “F8” Compressor 4 discharge temperature sensor error

**Error display:** ODU mainboard, IDU wired controller and IDU receive light board will

display 

**Error judgment condition and method:**

Sample the AD value of temperature sensors through temperature sensors circuit and judge the range of AD value; if the sampled AD value exceeds upper limit and lower limit in 30 seconds continuously, report the error.

**Possible reason:**

- Poor contact between discharge temperature sensor and terminal in mainboard interface
- Discharge temperature sensor is abnormal
- Detecting circuit is abnormal

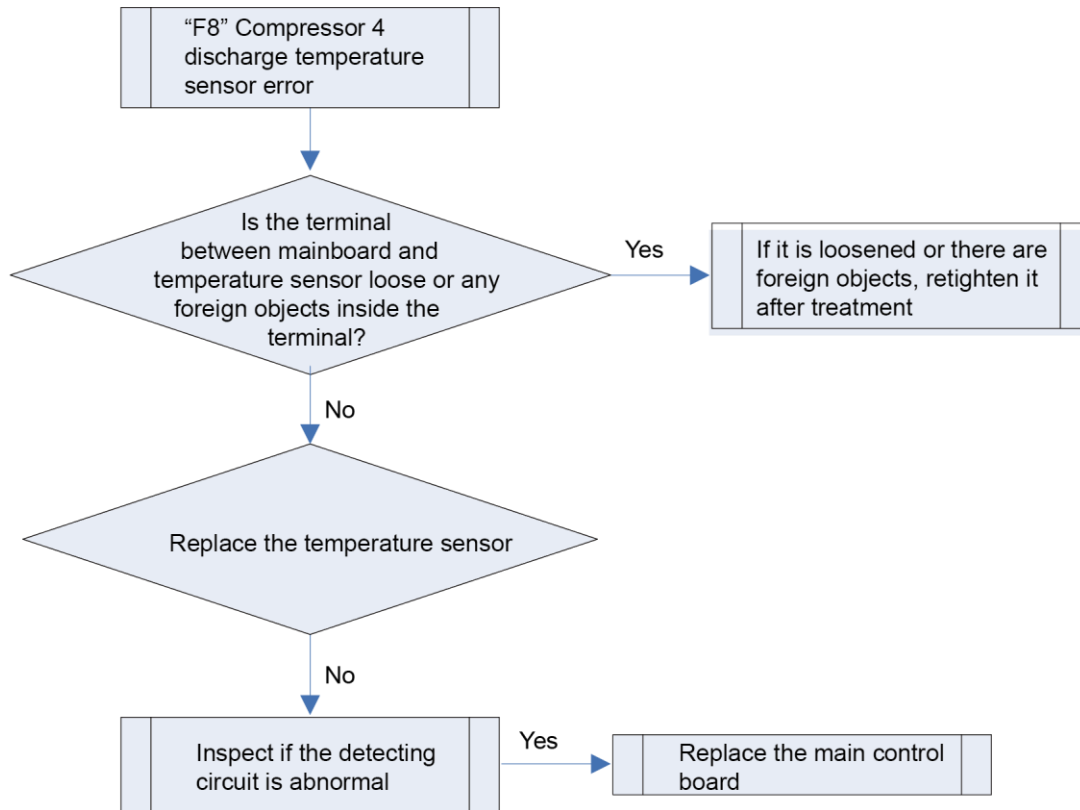
**Troubleshooting:**

## 2.3.4.65 "F9" Compressor 5 discharge temperature sensor error

**Error display:** ODU mainboard, IDU wired controller and IDU receive light board will

display 

**Error judgment condition and method:**

Sample the AD value of temperature sensors through temperature sensors circuit and judge the range of AD value; if the sampled AD value exceeds upper limit and lower limit in 30 seconds continuously, report the error.

**Possible reason:**

- Poor contact between discharge temperature sensor and terminal in mainboard interface
- Discharge temperature sensor is abnormal
- Detecting circuit is abnormal

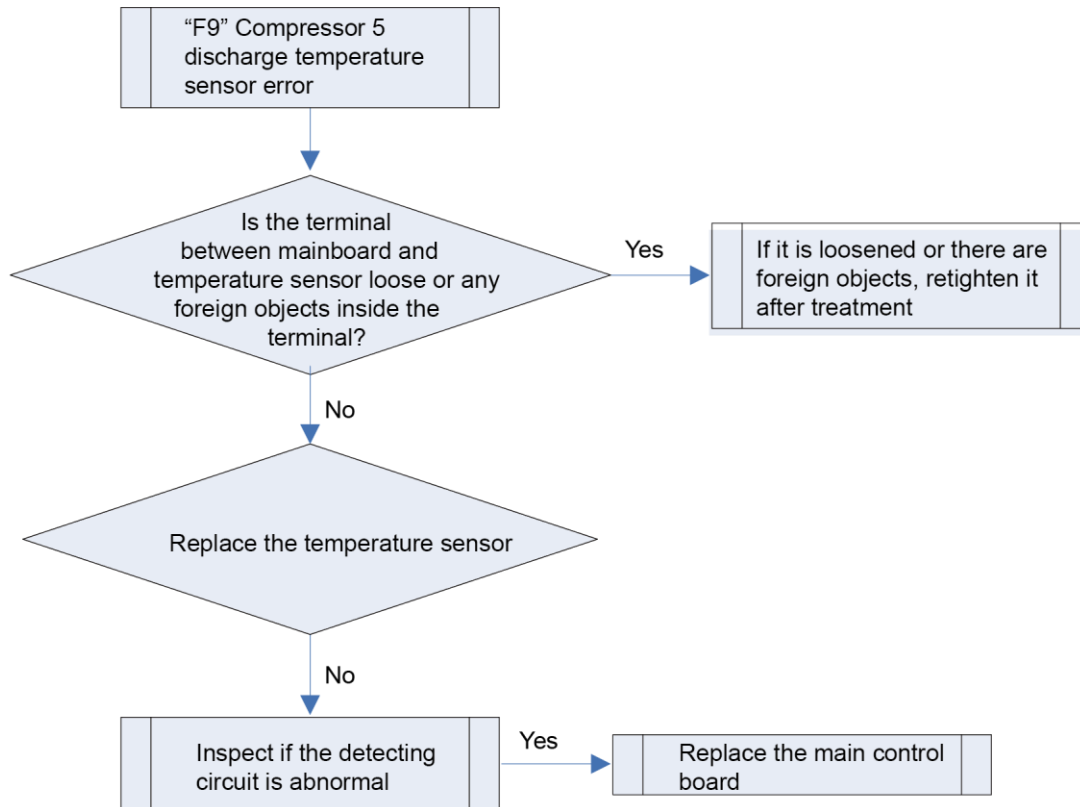
**Troubleshooting:**

## 2.3.4.66 “FA” Compressor 6 discharge temperature sensor error

**Error display:** ODU mainboard, IDU wired controller and IDU receive light board will

display 

**Error judgment condition and method:**

Sample the AD value of temperature sensors through temperature sensors circuit and judge the range of AD value; if the sampled AD value exceeds upper limit and lower limit in 30 seconds continuously, report the error.

**Possible reason:**

- Poor contact between discharge temperature sensor and terminal in mainboard interface
- Discharge temperature sensor is abnormal
- Detecting circuit is abnormal

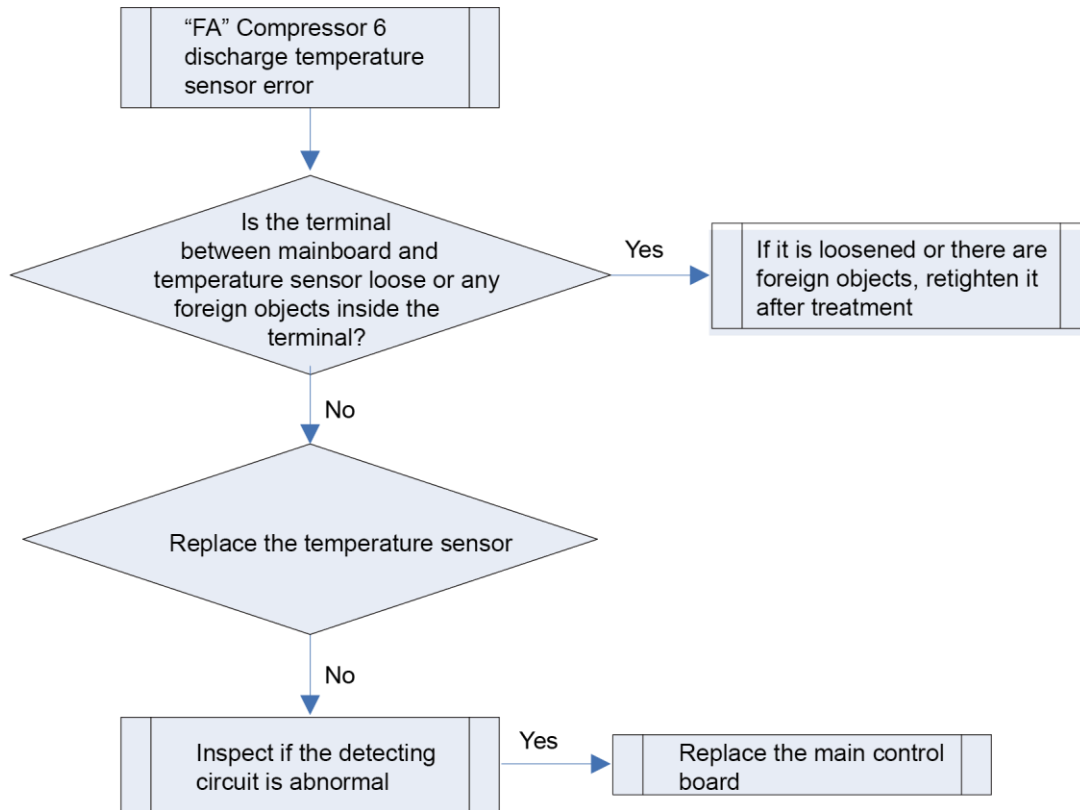
**Troubleshooting:**

## 2.3.4.67 “FH” Compressor 1 current sensor error

**Error display:** ODU mainboard, IDU wired controller and IDU receive light board will

display 

**Error judgment condition and method:**

Sample the AD value of current sensor through detecting circuit and judge the range of AD value; if the sampled AD value exceeds upper limit and lower limit in 3 seconds continuously, report the error.

**Possible reason:**

- Poor contact between circuit sensor and terminal in mainboard interface
- Small board of circuit sensor is abnormal
- Detecting circuit is abnormal

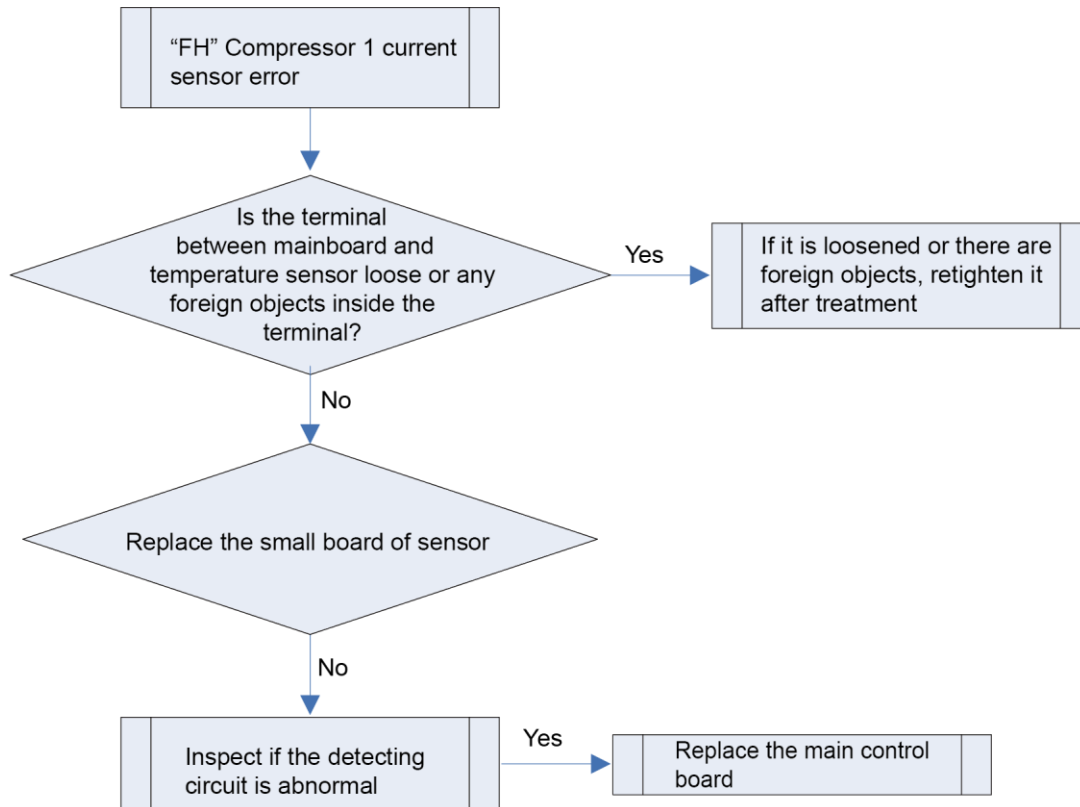
**Troubleshooting:**

## 2.3.4.68 “FC” Compressor 2 current sensor error

**Error display:** ODU mainboard, IDU wired controller and IDU receive light board will

display 

**Error judgment condition and method:**

Sample the AD value of current sensor through detecting circuit and judge the range of AD value; if the sampled AD value exceeds upper limit and lower limit in 3 seconds continuously, report the error.

**Possible reason:**

- Poor contact between circuit sensor and terminal in mainboard interface
- Small board of circuit sensor is abnormal
- Detecting circuit is abnormal

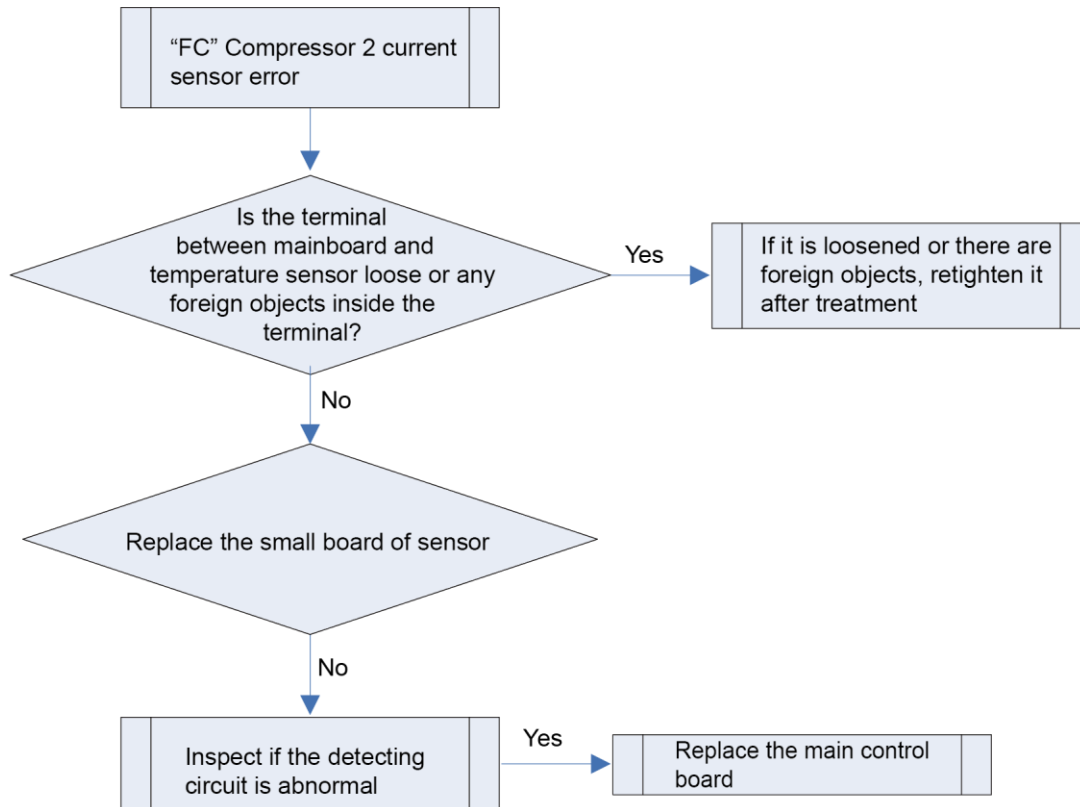

**Troubleshooting:**

## 2.3.4.69 "FL" Compressor 3 current sensor error

**Error display:** ODU mainboard, IDU wired controller and IDU receive light board will

display

**Error judgment condition and method:**

Sample the AD value of current sensor through detecting circuit and judge the range of AD value; if the sampled AD value exceeds upper limit and lower limit in 3 seconds continuously, report the error.

**Possible reason:**

- Poor contact between circuit sensor and terminal in mainboard interface
- Small board of circuit sensor is abnormal
- Detecting circuit is abnormal

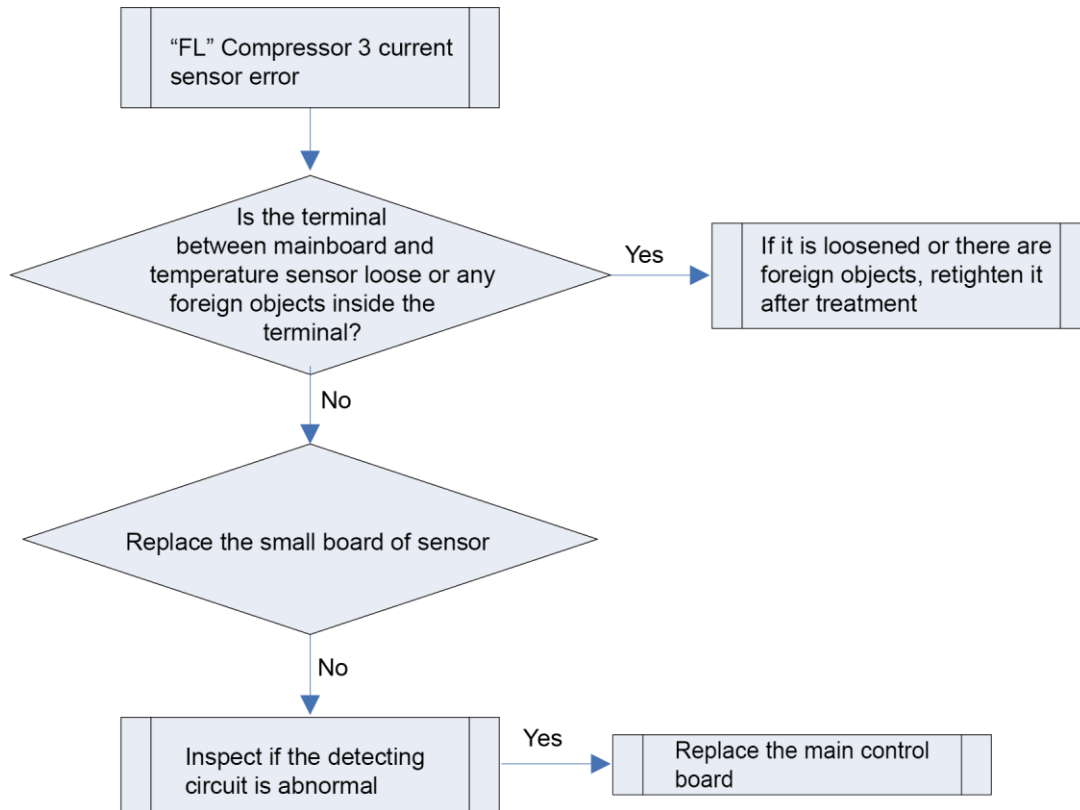
**Troubleshooting:**

## 2.3.4.70 “FE” Compressor 4 current sensor error

**Error display:** ODU mainboard, IDU wired controller and IDU receive light board will

display 

**Error judgment condition and method:**

Sample the AD value of current sensor through detecting circuit and judge the range of AD value; if the sampled AD value exceeds upper limit and lower limit in 3 seconds continuously, report the error.

**Possible reason:**

- Poor contact between circuit sensor and terminal in mainboard interface
- Small board of circuit sensor is abnormal
- Detecting circuit is abnormal

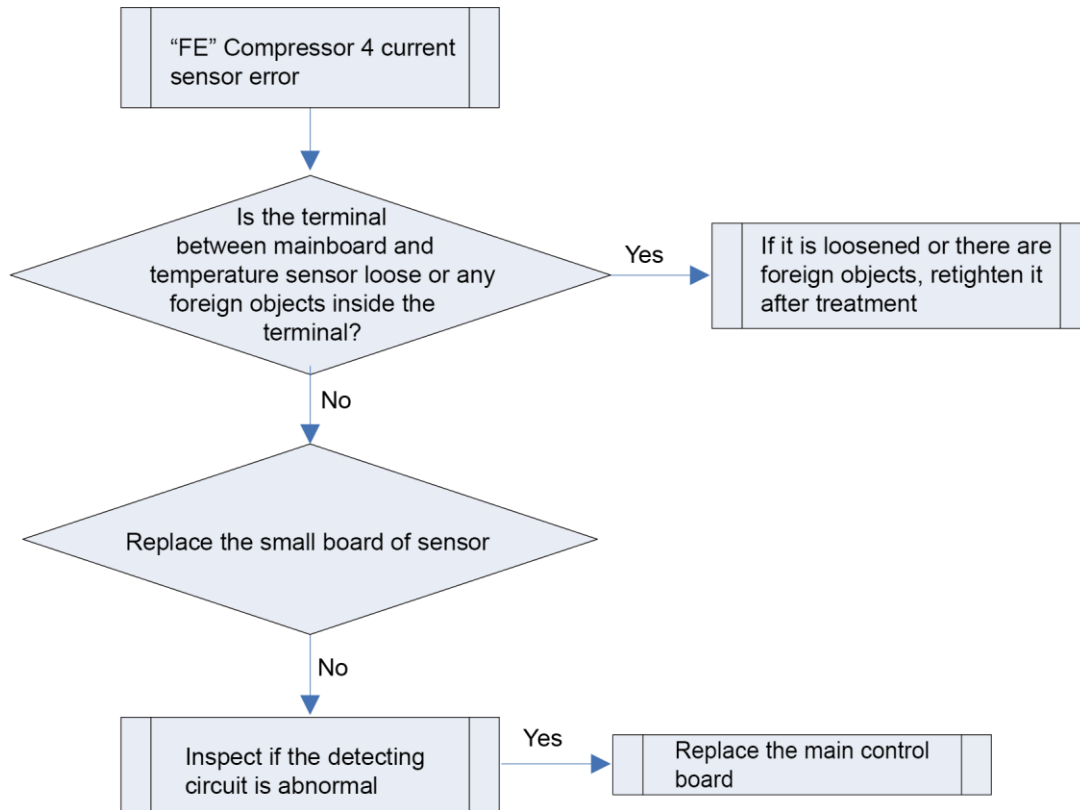
**Troubleshooting:**

## 2.3.4.71 “FF” Compressor 5 current sensor error

**Error display:** ODU mainboard, IDU wired controller and IDU receive light board will

display 

**Error judgment condition and method:**

Sample the AD value of current sensor through detecting circuit and judge the range of AD value; if the sampled AD value exceeds upper limit and lower limit in 3 seconds continuously, report the error.

**Possible reason:**

- Poor contact between circuit sensor and terminal in mainboard interface
- Small board of circuit sensor is abnormal
- Detecting circuit is abnormal

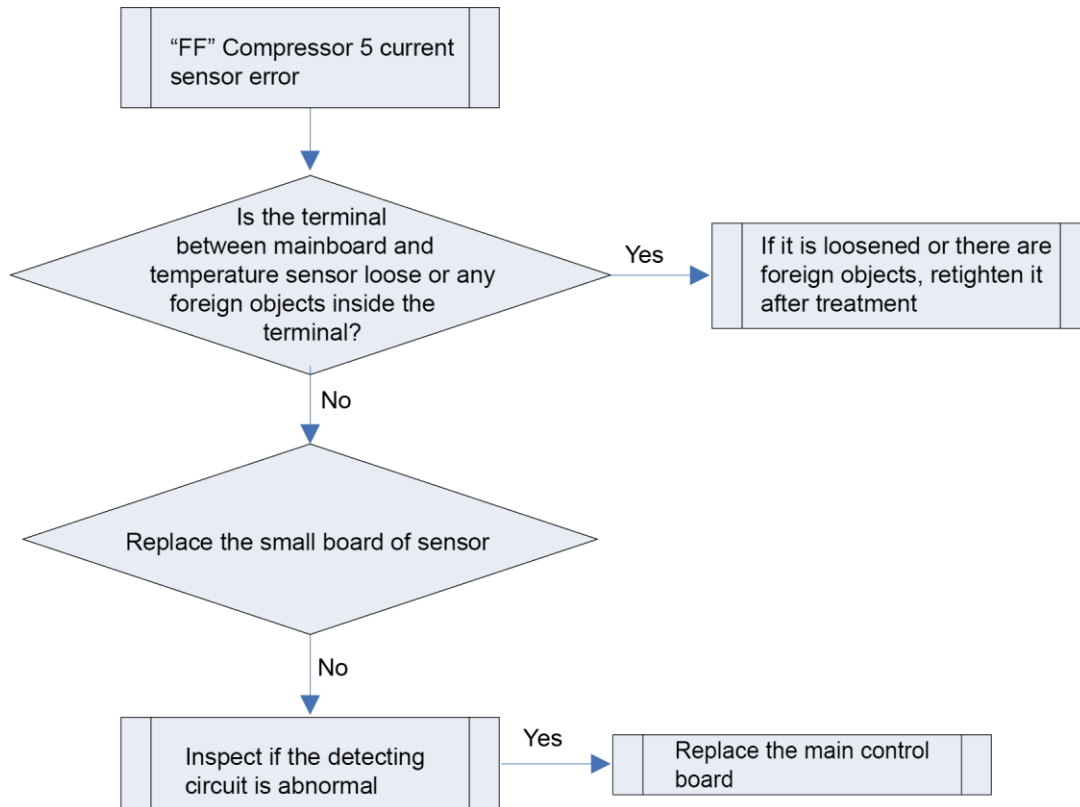
**Troubleshooting:**

## 2.3.4.72 "FJ" Compressor 6 current sensor error

**Error display:** ODU mainboard, IDU wired controller and IDU receive light board will

display 

**Error judgment condition and method:**

Sample the AD value of current sensor through detecting circuit and judge the range of AD value; if the sampled AD value exceeds upper limit and lower limit in 3 seconds continuously, report the error.

**Possible reason:**

- Poor contact between circuit sensor and terminal in mainboard interface
- Small board of circuit sensor is abnormal
- Detecting circuit is abnormal

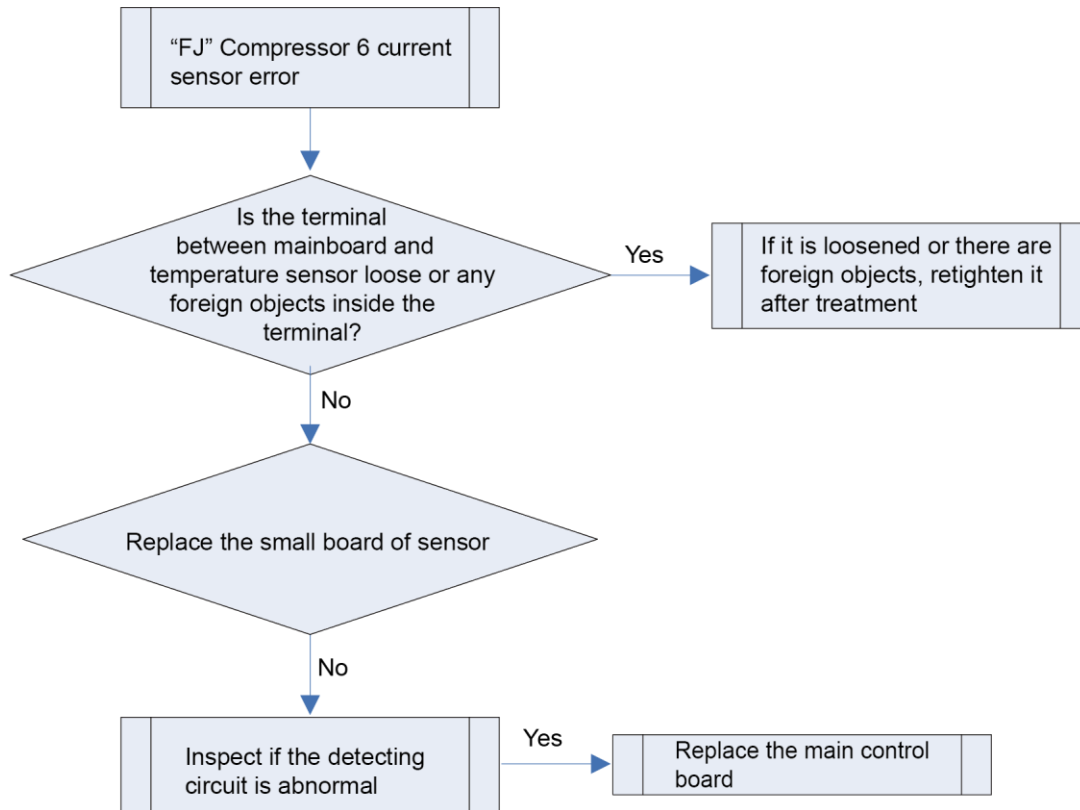
**Troubleshooting:**

## 2.3.4.73 “FU” Compressor 1 shell top temperature sensor error

**Error display:** ODU mainboard, IDU wired controller and IDU receive light board will

display 

**Error judgment condition and method:**

Sample the AD value of temperature sensor through temperature sensor detecting circuit and judge the range of AD value. If the sampling AD value exceeds upper limit and lower limit in 30 seconds continuously, report the error

**Possible reason:**

- Poor contact between shell top temperature sensor and terminal in mainboard interface
- Shell top temperature sensor is abnormal
- Detecting circuit is abnormal

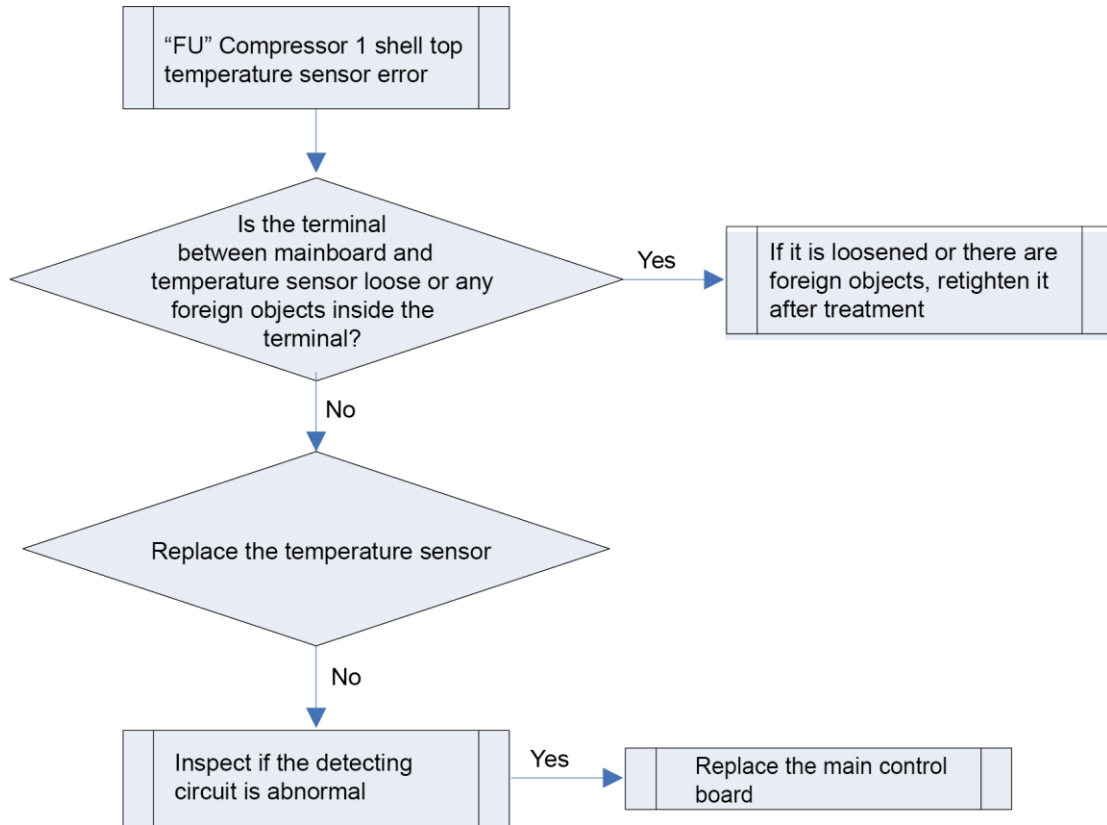
**Troubleshooting:**

## 2.3.4.74 "Fb" Compressor 2 shell top temperature sensor error

**Error display:** ODU mainboard, IDU wired controller and IDU receive light board will

display 

**Error judgment condition and method:**

Sample the AD value of temperature sensor through temperature sensor detecting circuit and judge the range of AD value. If the sampling AD value exceeds upper limit and lower limit in 30 seconds continuously, report the error

**Possible reason:**

- Poor contact between shell top temperature sensor and terminal in mainboard interface
- Shell top temperature sensor is abnormal
- Detecting circuit is abnormal

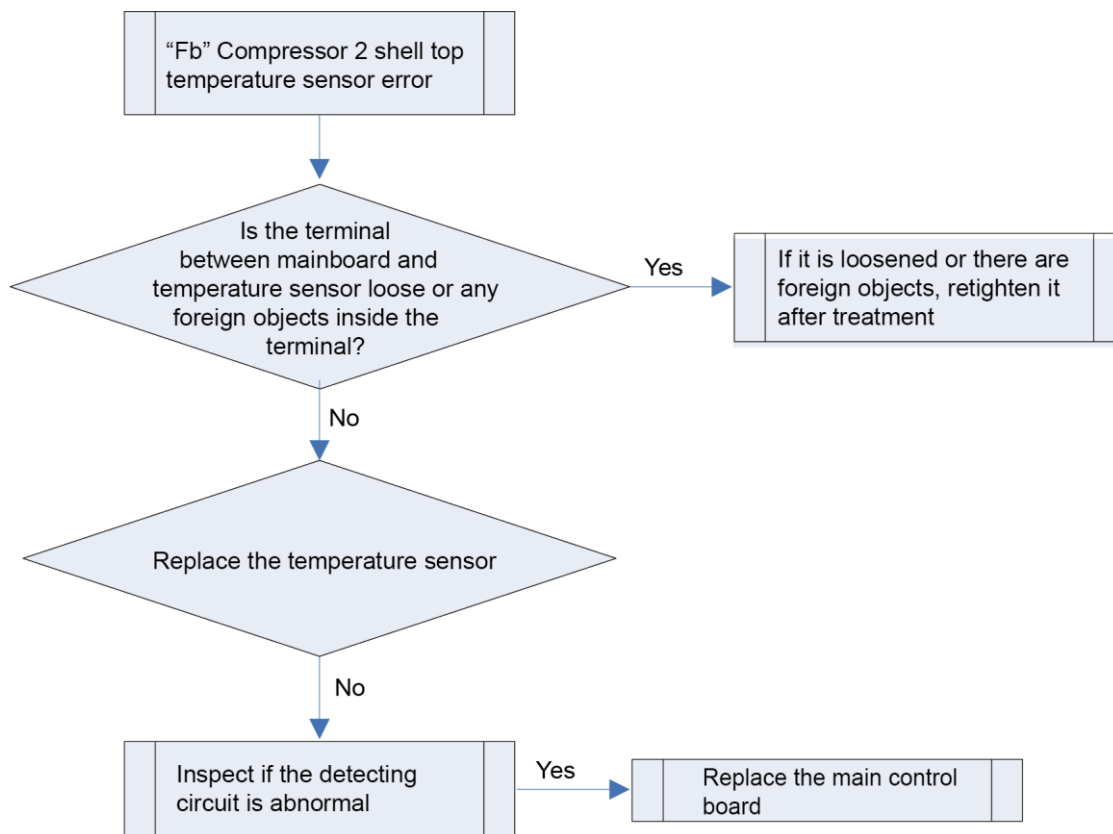
**Troubleshooting:**

## 2.3.4.75 “H0” Fan drive board error

**Error display:** IDU wired controller will display

**Error judgment condition and method:**

Check the error code on IDU wired controller. If IDU wired controller displays H0, you should also check the error code on nixie tube of ODU main control board. Judge the detailed error of fan drive board according to the error code on main control board and arrange troubleshooting accordingly.

**Possible reason:**

- Fan drive module reset protection (Nixie tube on ODU main control board displays H3)
- Fan drive temperature sensor error (Nixie tube on ODU main control board displays H7)
- Fan drive IPM high temperature protection (Nixie tube on ODU main control board displays H8)
- Fan drive current detecting circuit error (Nixie tube on ODU main control board displays HC)
- Fan drive charging circuit error (Nixie tube on ODU main control board displays HF)
- Inverter fan non-synchronism protection (Nixie tube on ODU main control board displays H9)
- Inverter fan startup failure (Nixie tube on ODU main control board displays HJ)

**Troubleshooting:**

Step one: Check IDU wired controller error code

Step two: Also check the error code on nixie tube of ODU main control board

Step three: Arrange troubleshooting according to the error code displayed on ODU nixie tube  
(Detailed troubleshooting steps refer to the corresponding error)

### 2.3.4.76 “H1” Fan drive board operation error

**Error display:** IDU wired controller will display



**Error judgment condition and method:**

Check the error code on IDU wired controller. If IDU wired controller displays H1, you should also check the error code on nixie tube of ODU main control board. Judge the detailed error of fan drive board according to the error code on main control board and arrange troubleshooting accordingly.

**Possible reason:**

- Fan drive IPM module protection (Nixie tube on ODU main control board displays H6)
- Inverter fan overcurrent protection (Nixie tube on ODU main control board displays H5)
- Fan drive communication error (Nixie tube on ODU main control board displays C3)

**Troubleshooting:**

Step one: Check IDU wired controller error code

Step two: Also check the error code on nixie tube of ODU main control board

Step three: Arrange troubleshooting according to the error code displayed on ODU nixie tube (Detailed troubleshooting steps refer to the corresponding error)

### 2.3.4.77 “H2” Fan drive board power supply voltage protection

**Error display:** IDU wired controller will display



**Error judgment condition and method:**

Check the error code on IDU wired controller. If IDU wired controller displays H2, you should also check the error code on nixie tube of ODU main control board. Judge the detailed error of fan drive board according to the error code on main control board and arrange troubleshooting accordingly.

**Possible reason:**

- Fan drive DC bus high voltage protection (Nixie tube on ODU main control board displays HH)
- Fan drive DC bus low voltage protection (Nixie tube on ODU main control board displays HL)

**Troubleshooting:**

Step one: Check IDU wired controller error code

Step two: Also check the error code on nixie tube of ODU main control board

Step three: Arrange troubleshooting according to the error code displayed on ODU nixie tube (Detailed troubleshooting steps refer to the corresponding error)

### 2.3.4.78 “H3” Fan drive module reset protection

**Error display:** IDU wired controller will display



**Error judgment condition and method:**

Check the error code on nixie tube of ODU main control board. If H3 is displayed, it indicates fan drive board module reset protection

**Possible reason:**



- Fan drive board is abnormal.

#### Troubleshooting:

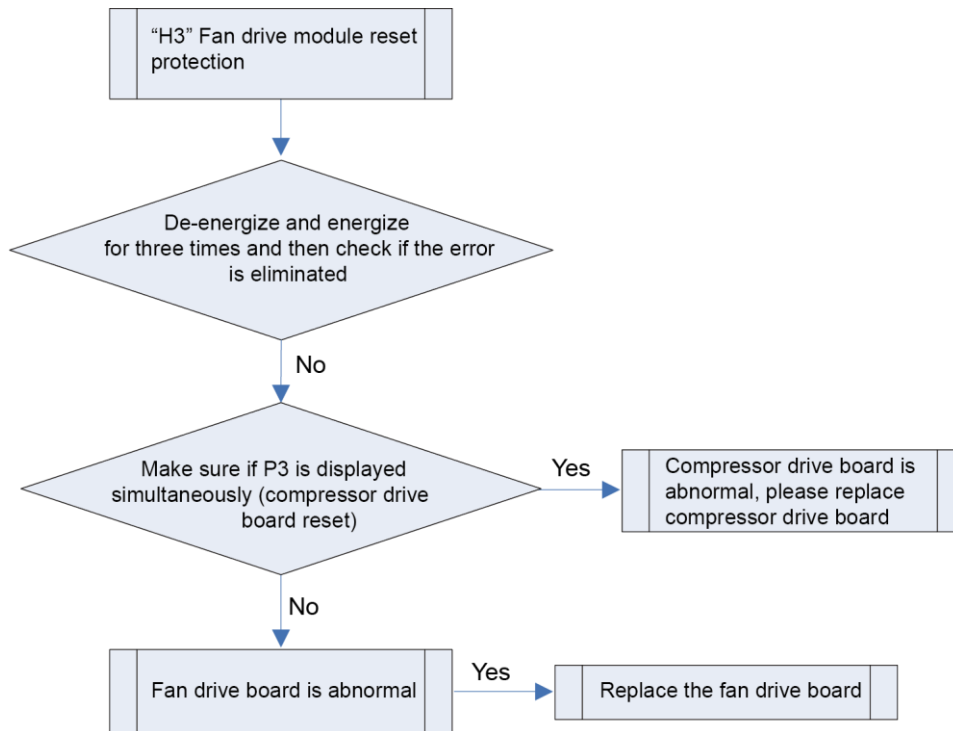

#### 2.3.4.79 "H5" Inverter fan overcurrent protection

**Error display:** ODU mainboard will display



#### **Error judgment condition and method:**

Check the error code on nixie tube of ODU main control board. If H5 is displayed, it indicates inverter fan overcurrent protection

#### **Possible reason:**

- Poor contact of fan UVW wire
- Fan is broken
- Fan blade is blocked (Fan blade is blocked and motor shaft is rusty)
- Fan drive board is abnormal

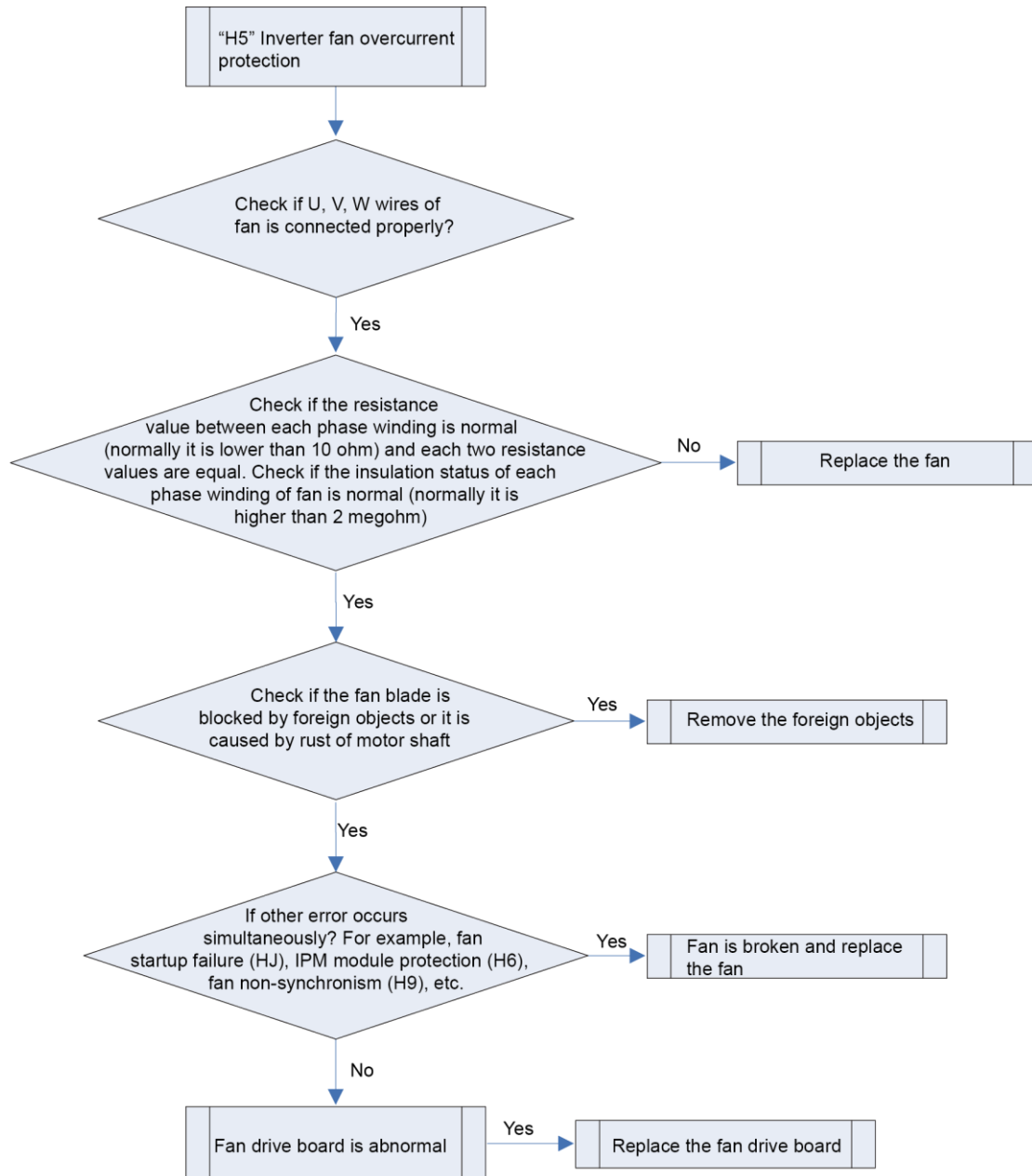
**Troubleshooting:**

## 2.3.4.80 "H6" Drive IPM module protection of fan

**Error display:** ODU mainboard will display

**Error judgment condition and method:**

Check the error code on nixie tube of ODU main control board. If H6 is displayed, it indicates Drive IPM module protection of fan

**Possible reason:**

- Poor contact of fan UVW wire
- Fan is broken
- Fan blade is blocked (Fan blade is blocked and motor shaft is rusty)
- Fan drive board is abnormal

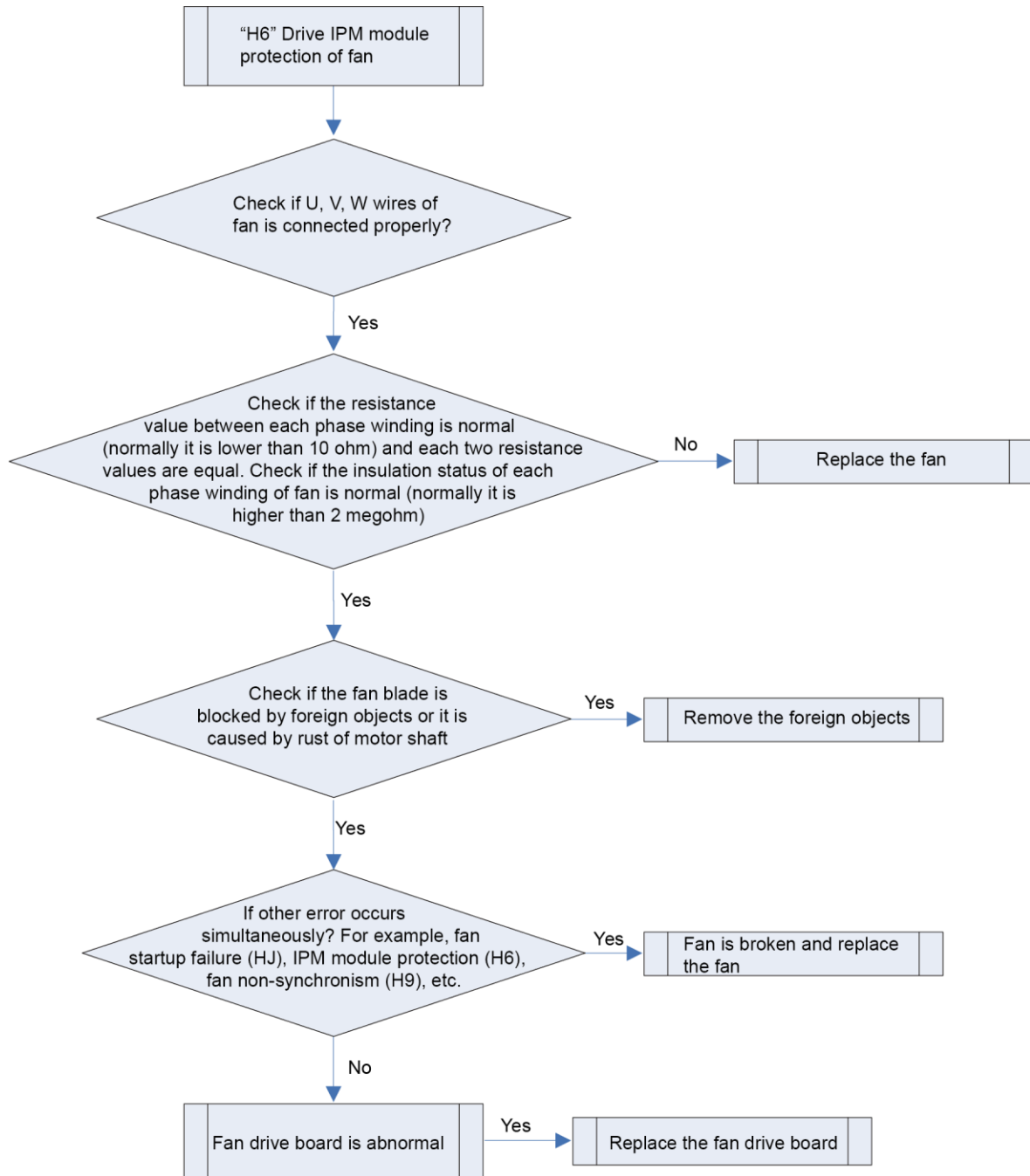
**Troubleshooting:**

## 2.3.4.81 "H7" Fan drive temperature sensor error

**Error display:** ODU mainboard will display

**Error judgment condition and method:**

Check the error code on nixie tube of ODU main control board. If H7 is displayed, it indicates fan drive temperature sensor error

**Possible reason:**

- Fan drive board is abnormal

**Troubleshooting:**

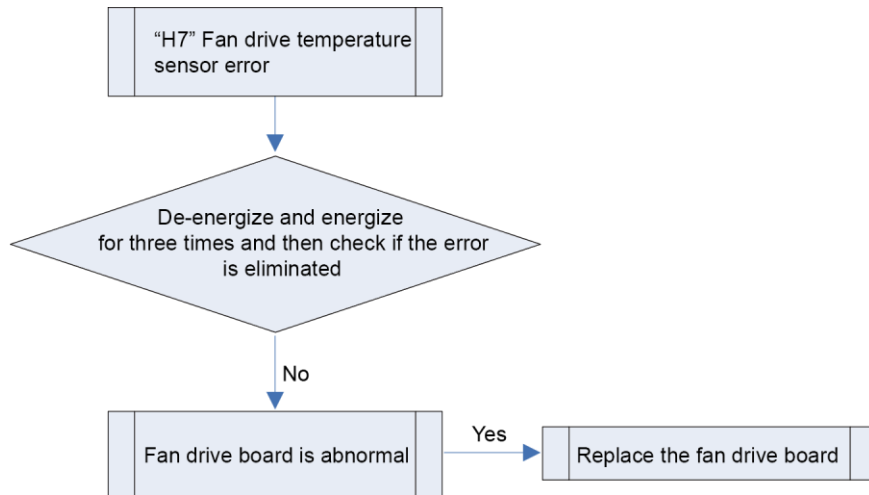

2.3.4.82 “H8” Fan drive IPM high temperature protection

**Error display:** ODU mainboard will display 

**Error judgment condition and method:**

Check the error code on nixie tube of ODU main control board. If H8 is displayed, it indicates fan drive IPM high temperature protection

**Possible reason:**

- Thermal grease of IPM module hasn't been spread or thermal grease is not spread evenly or thermal grease is dry;
- Screw of IPM module is not tightened;
- Fan drive board is abnormal

**Troubleshooting:**

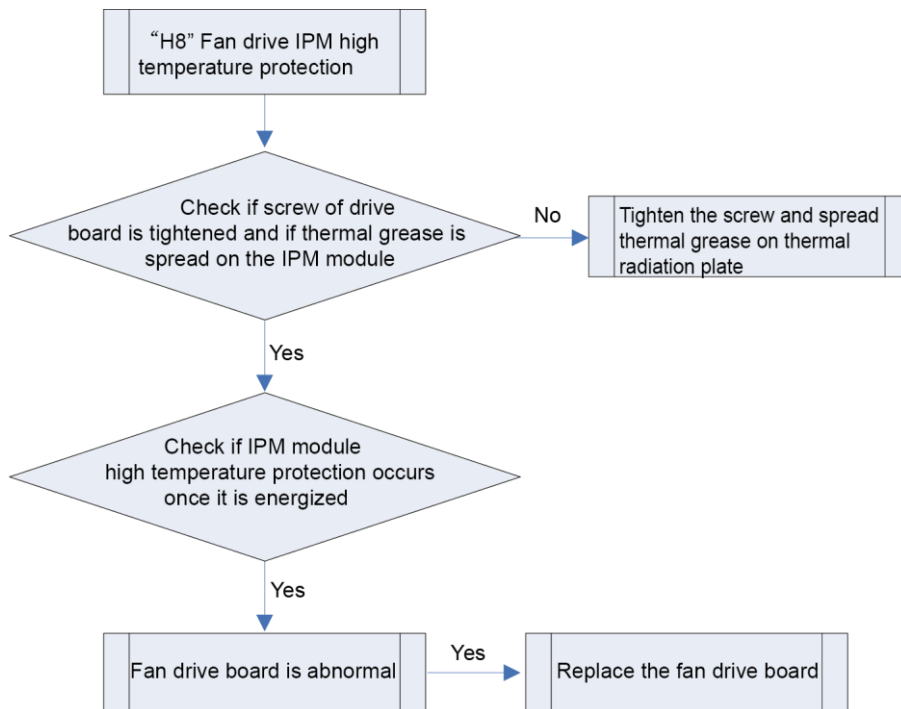

## 2.3.4.83 “H9” Desynchronizing protection of inverter compressor

**Error display:** ODU mainboard will display



**Error judgment condition and method:**

Check the error code on nixie tube of ODU main control board. If H9 is displayed, it indicates Desynchronizing protection of inverter compressor

**Possible reason:**

- Poor contact of fan UVW wire
- Fan is broken
- Fan blade is blocked (Fan blade is blocked and motor shaft is rusty)
- Fan drive board is abnormal

**Troubleshooting:**

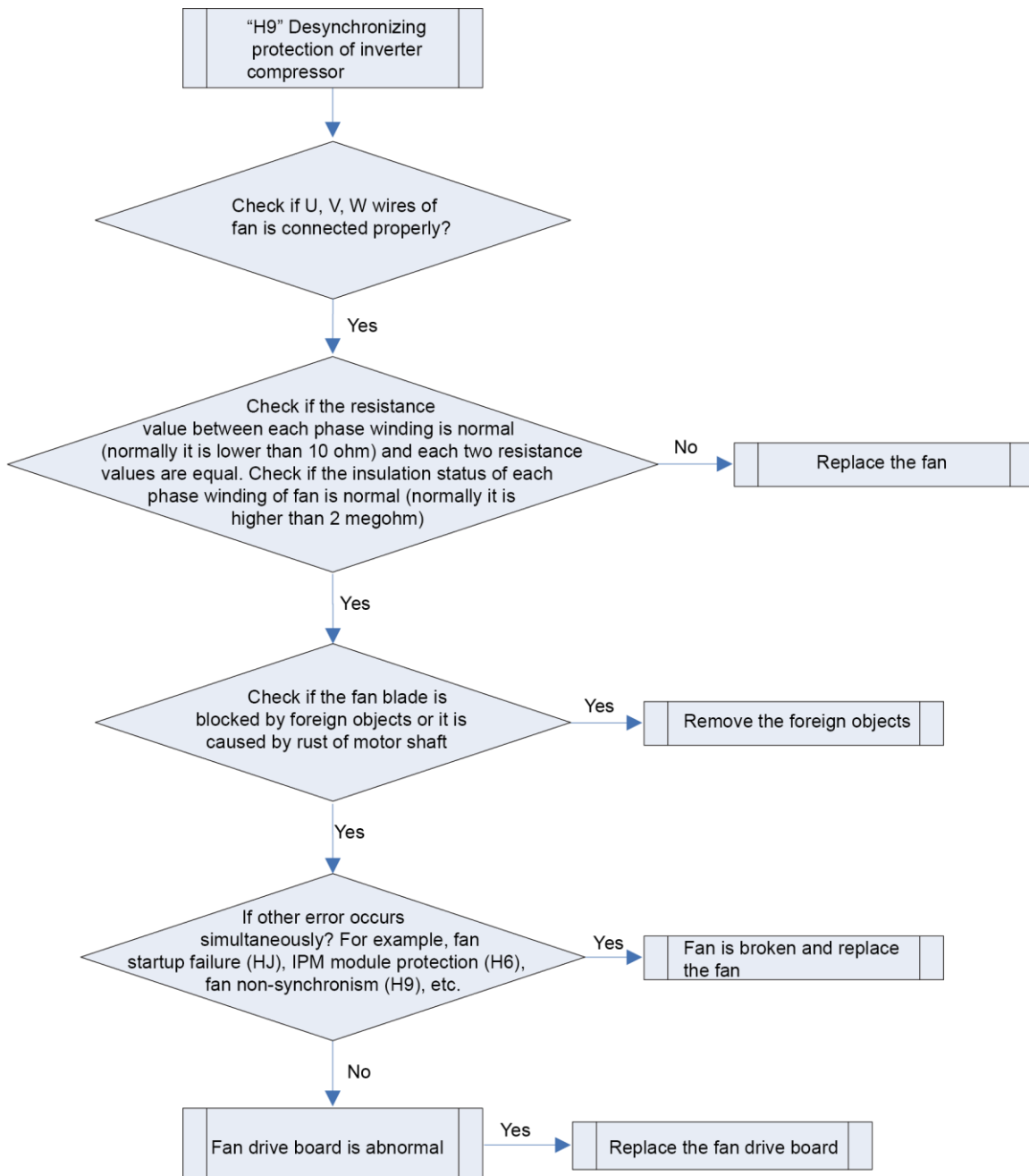

2.3.4.84 “HC” AC input voltage of drive of inverter fan

**Error display:** ODU mainboard will display



**Error judgment condition and method:**

Check the error code on nixie tube of ODU main control board. If HC is displayed, it indicates AC input voltage of drive of inverter fan

**Possible reason:**

- Fan drive board is abnormal

**Troubleshooting:**

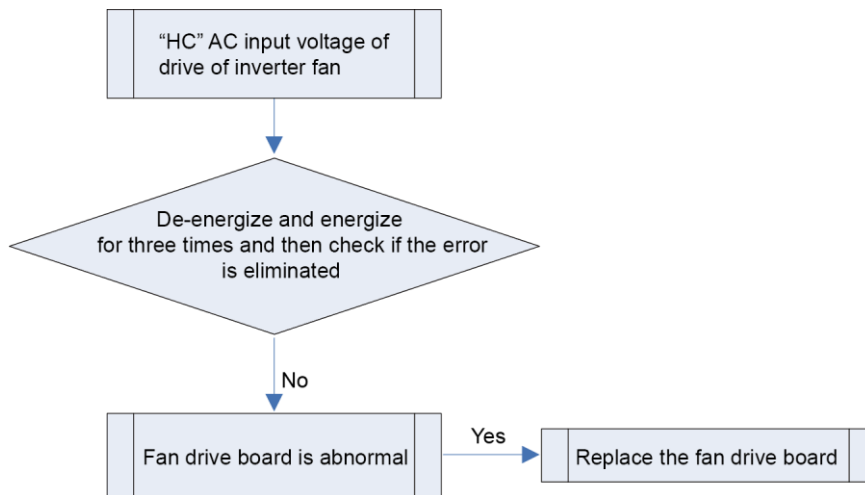

2.3.4.85 “HH” fan drive DC bus high voltage protection

**Error display:** ODU mainboard will display



**Error judgment condition and method:**

Check the error code on nixie tube of ODU main control board. If HH is displayed, it indicates fan drive DC bus high voltage protection

**Possible reason:**

- Power supply voltage is higher than 460V;
- Fan drive board is abnormal.

**Troubleshooting:**

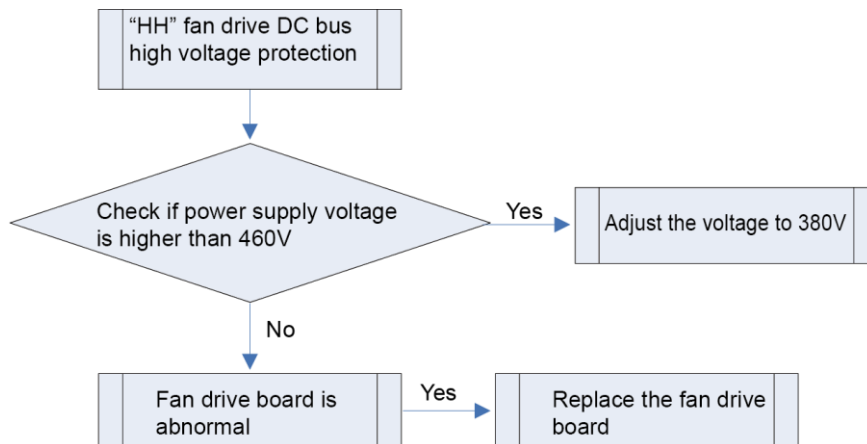

### 2.3.4.86 “HL” Fan drive DC bus low voltage protection

**Error display:** ODU mainboard will display



**Error judgment condition and method:**

Check the error code on nixie tube of ODU main control board. If HL is displayed, it indicates fan drive DC bus low voltage protection

**Possible reason:**

- Power supply voltage is lower than 320V;
- Fan drive board is abnormal.

**Troubleshooting:**

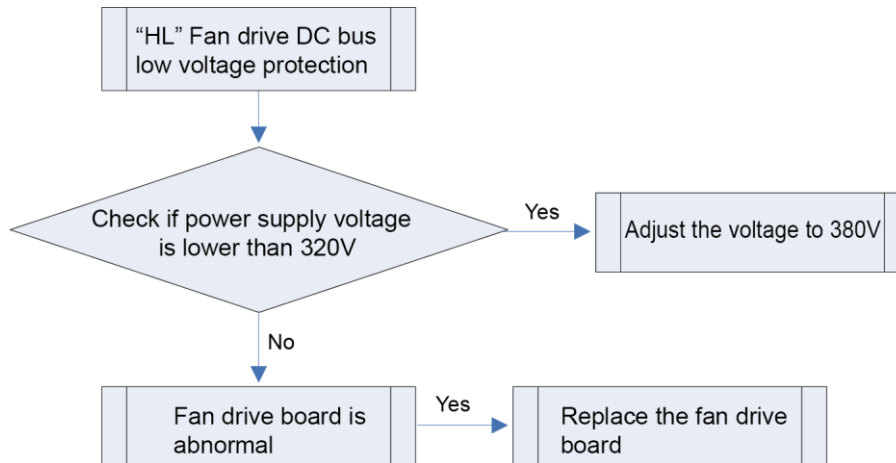

### 2.3.4.87 “HJ” Failure startup of inverter fan

**Error display:** ODU mainboard will display



**Error judgment condition and method:**

Check the error code on nixie tube of ODU main control board. If HJ is displayed, it indicates Failure startup of inverter fan

**Possible reason:**

- Poor contact of fan UVW wire
- Fan is broken
- Fan blade is blocked (Fan blade is blocked and motor shaft is rusty)
- Fan drive board is abnormal

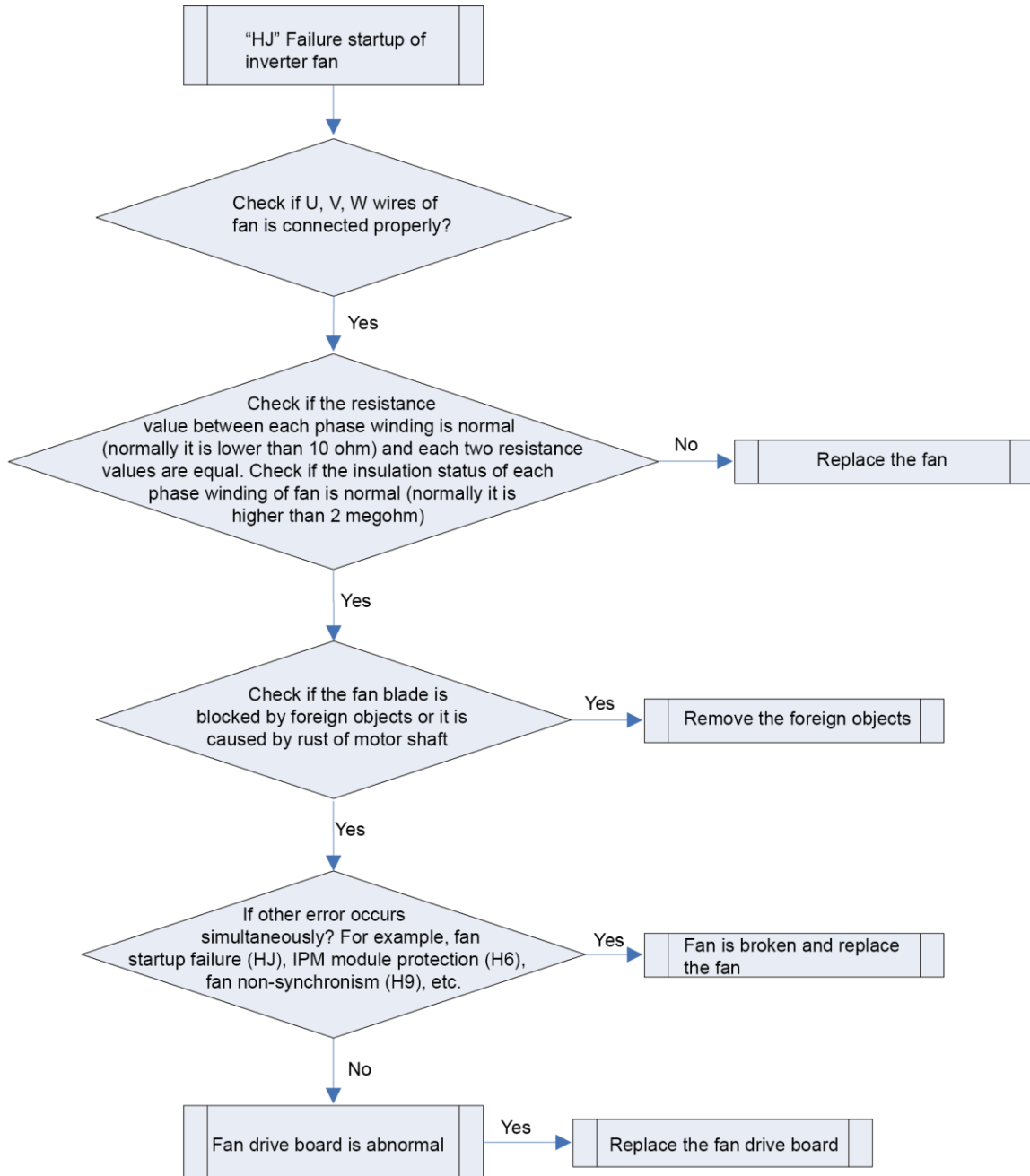
**Troubleshooting:**

## 2.3.4.88 “J0” Other module protection

**Error display:** ODU mainboard will display



. IDU and IDU receive light board will not

display.

**Error judgment condition and method:**

In multiple modules system, if any module causes system stoppage, the modules without errors will display this error to indicate other module has error, which causes unit stoppage.

**Possible reason:**

- Other module has error for stoppage;

**Troubleshooting:**

Eliminate the error of other modules.



### 2.3.4.89 "J1" Compressor 1 overcurrent protection

**Error display:** ODU mainboard, IDU wired controller and IDU receive light board will display



**Error judgment condition and method:**

Check the operation current of compressor through current sensor or circuit. When current exceeds the limit, the unit will stop for protection.

**Possible reason:**

- System parameters are abnormal;
- Drive module is abnormal;
- Compressor is abnormal;

**Troubleshooting:**

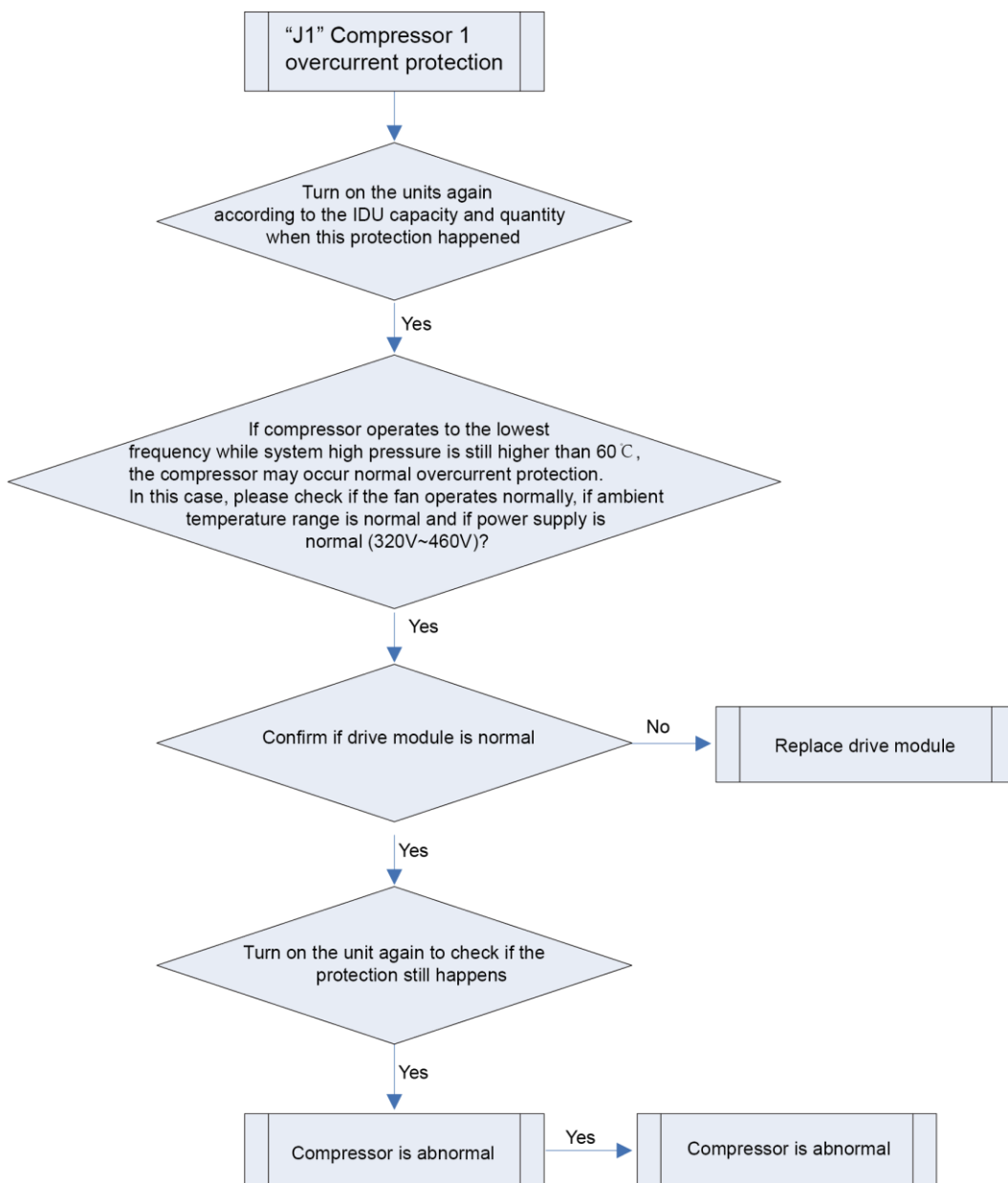

2.3.4.90 “J2” Compressor 2 overcurrent protection

**Error display:** ODU mainboard, IDU wired controller and IDU receive light board will display



**Error judgment condition and method:**

Check the operation current of compressor through current sensor or circuit. When current exceeds the limit, the unit will stop for protection.

**Possible reason:**

- System parameters are abnormal;
- Drive module is abnormal;
- Compressor is abnormal;

**Troubleshooting:**

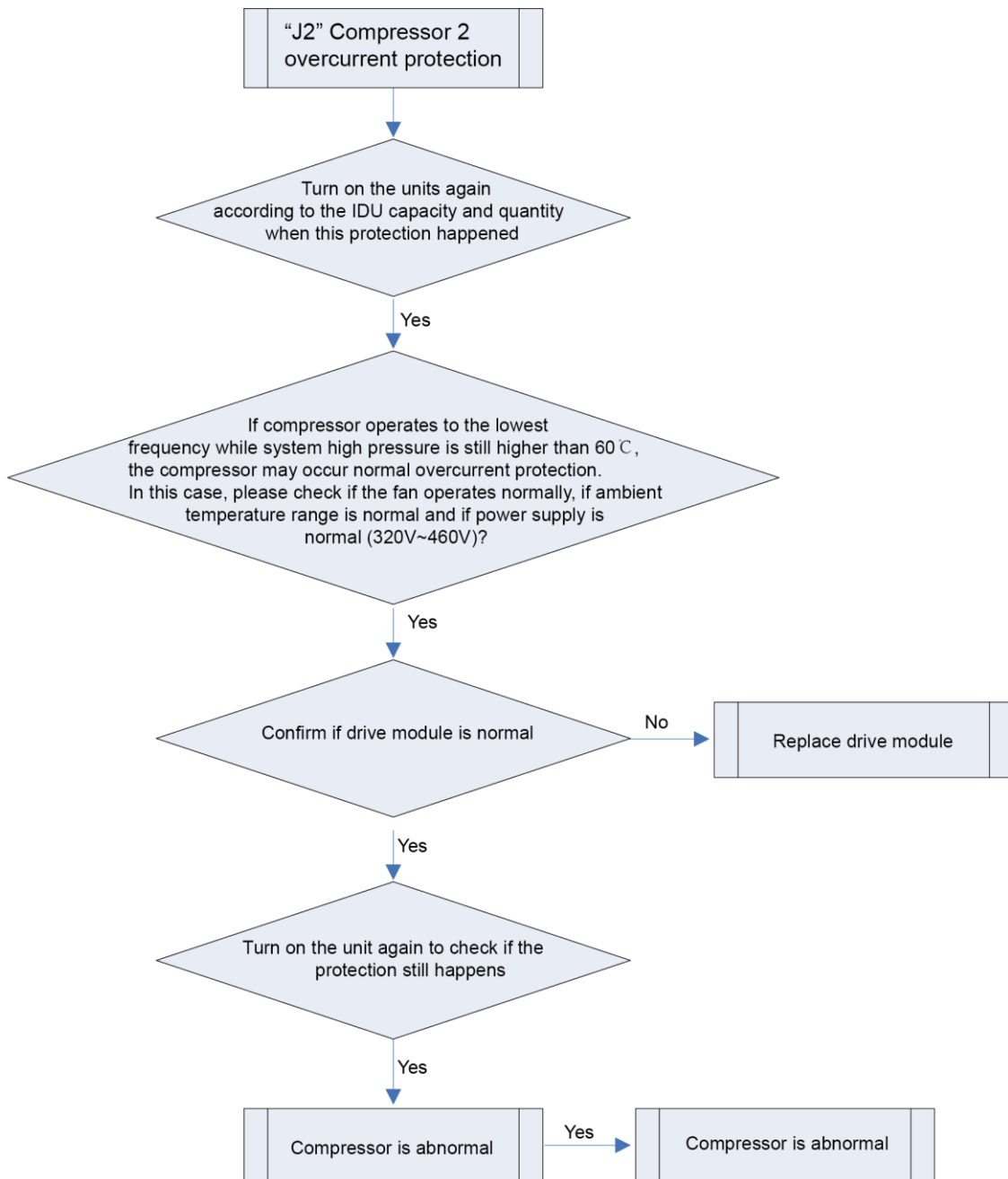

2.3.4.91 “J3” Compressor 3 overcurrent protection

**Error display:** ODU mainboard, IDU wired controller and IDU receive light board will display



**Error judgment condition and method:**

Check the operation current of compressor through current sensor or circuit. When current exceeds the limit, the unit will stop for protection.

**Possible reason:**

- System parameters are abnormal;
- Drive module is abnormal;
- Compressor is abnormal;

**Troubleshooting:**

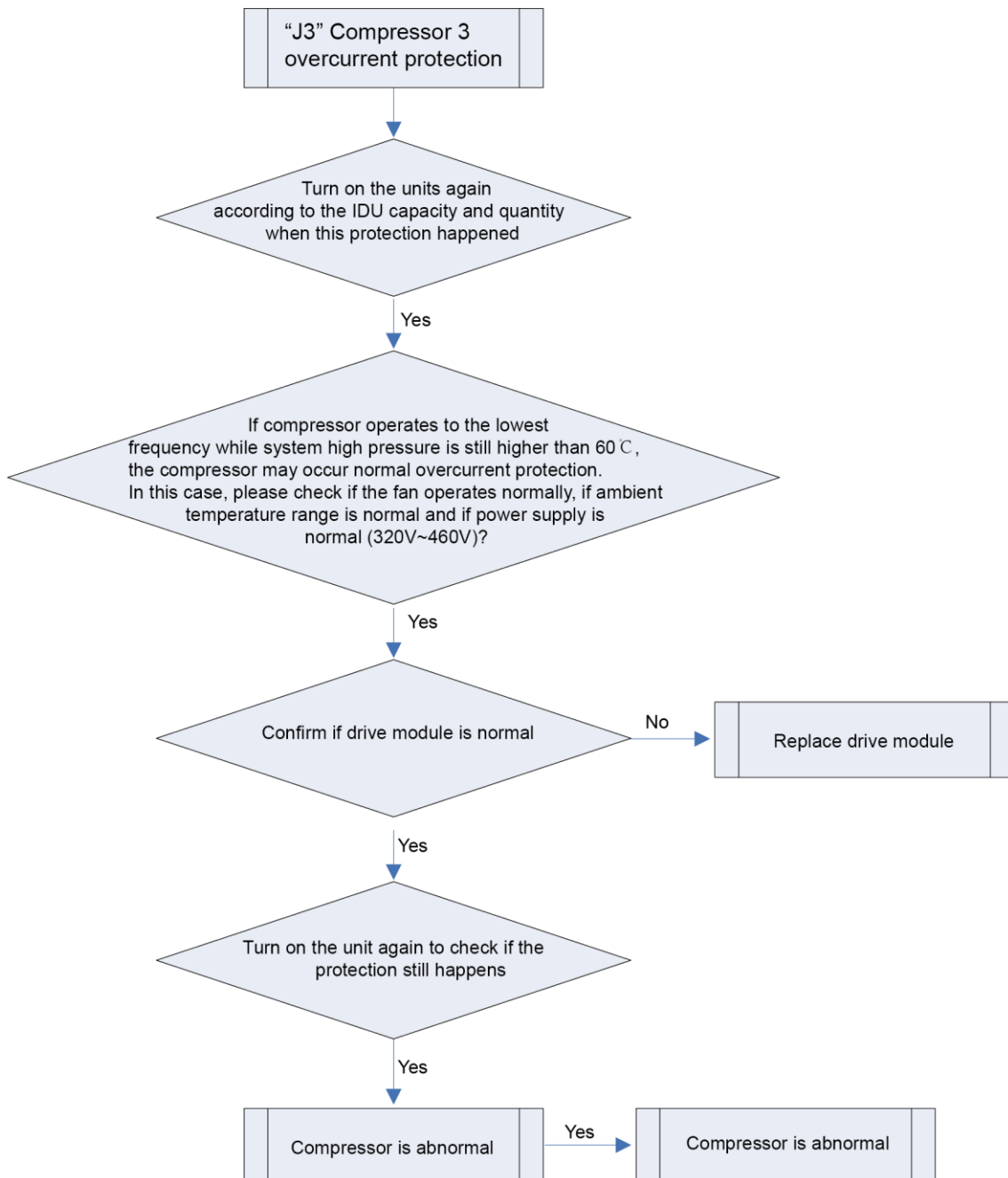

2.3.4.92 “J4” Compressor 4 overcurrent protection

**Error display:** ODU mainboard, IDU wired controller and IDU receive light board will display



**Error judgment condition and method:**

Check the operation current of compressor through current sensor or circuit. When current exceeds the limit, the unit will stop for protection.

**Possible reason:**

- System parameters are abnormal;
- Drive module is abnormal;
- Compressor is abnormal;

**Troubleshooting:**

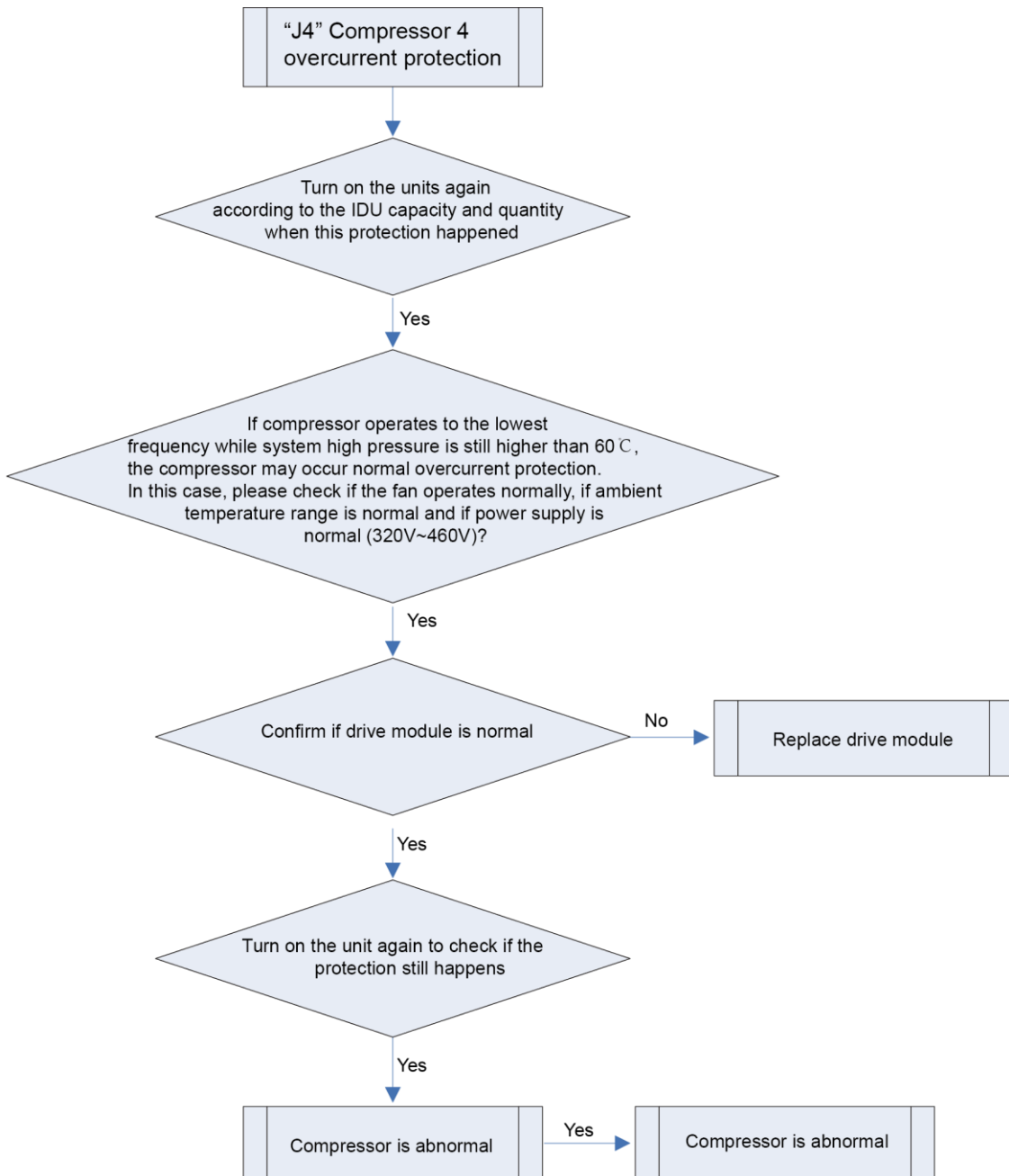

2.3.4.93 “J5” Compressor 5 overcurrent protection

**Error display:** ODU mainboard, IDU wired controller and IDU receive light board will display



**Error judgment condition and method:**

Check the operation current of compressor through current sensor or circuit. When current exceeds the limit, the unit will stop for protection.

**Possible reason:**

- System parameters are abnormal;
- Drive module is abnormal;
- Compressor is abnormal;

**Troubleshooting:**

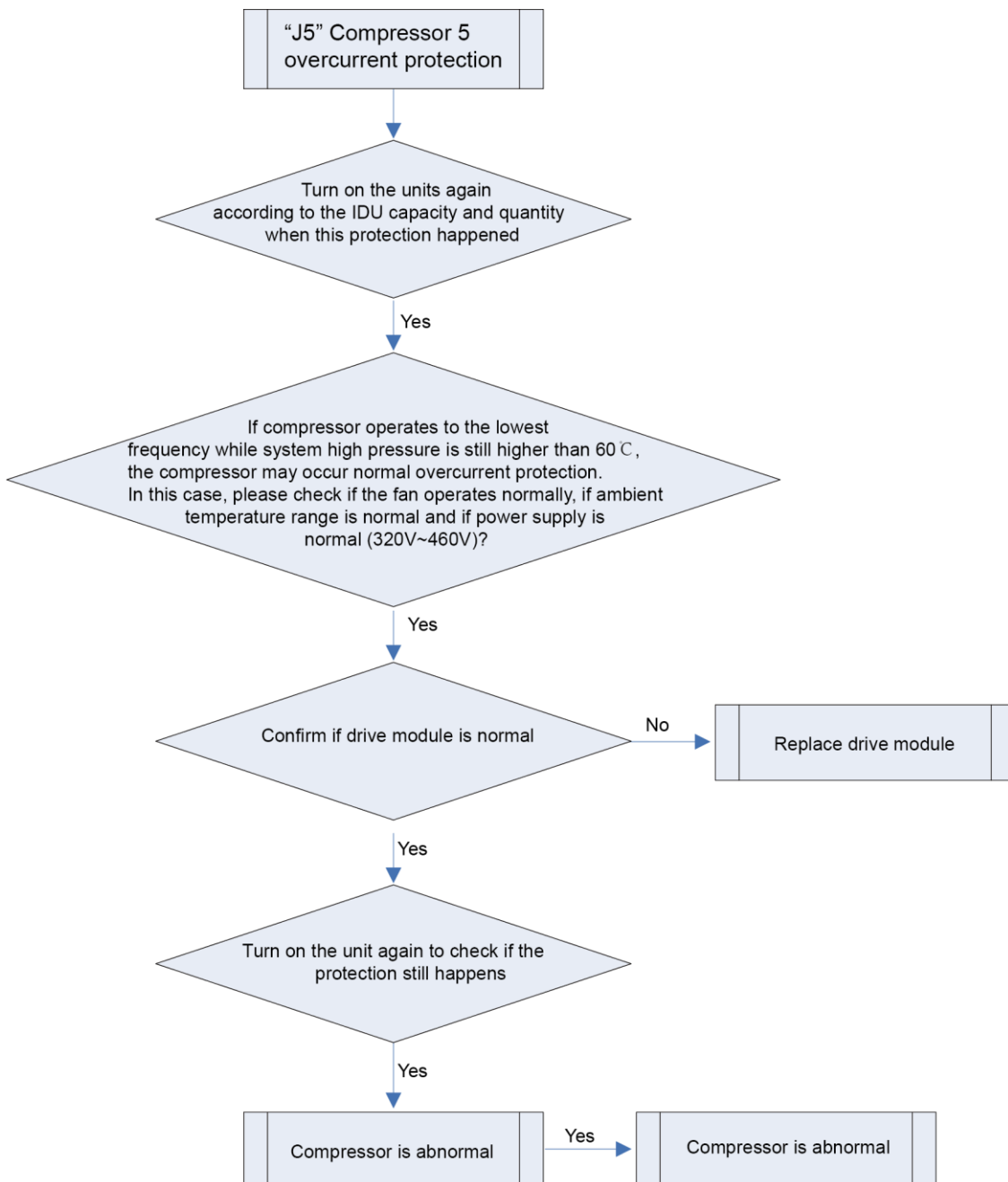

2.3.4.94 “J6” Compressor 6 overcurrent protection

**Error display:** ODU mainboard, IDU wired controller and IDU receive light board will display



**Error judgment condition and method:**

Check the operation current of compressor through current sensor or circuit. When current exceeds the limit, the unit will stop for protection.

**Possible reason:**

- System parameters are abnormal;
- Drive module is abnormal;
- Compressor is abnormal;

**Troubleshooting:**

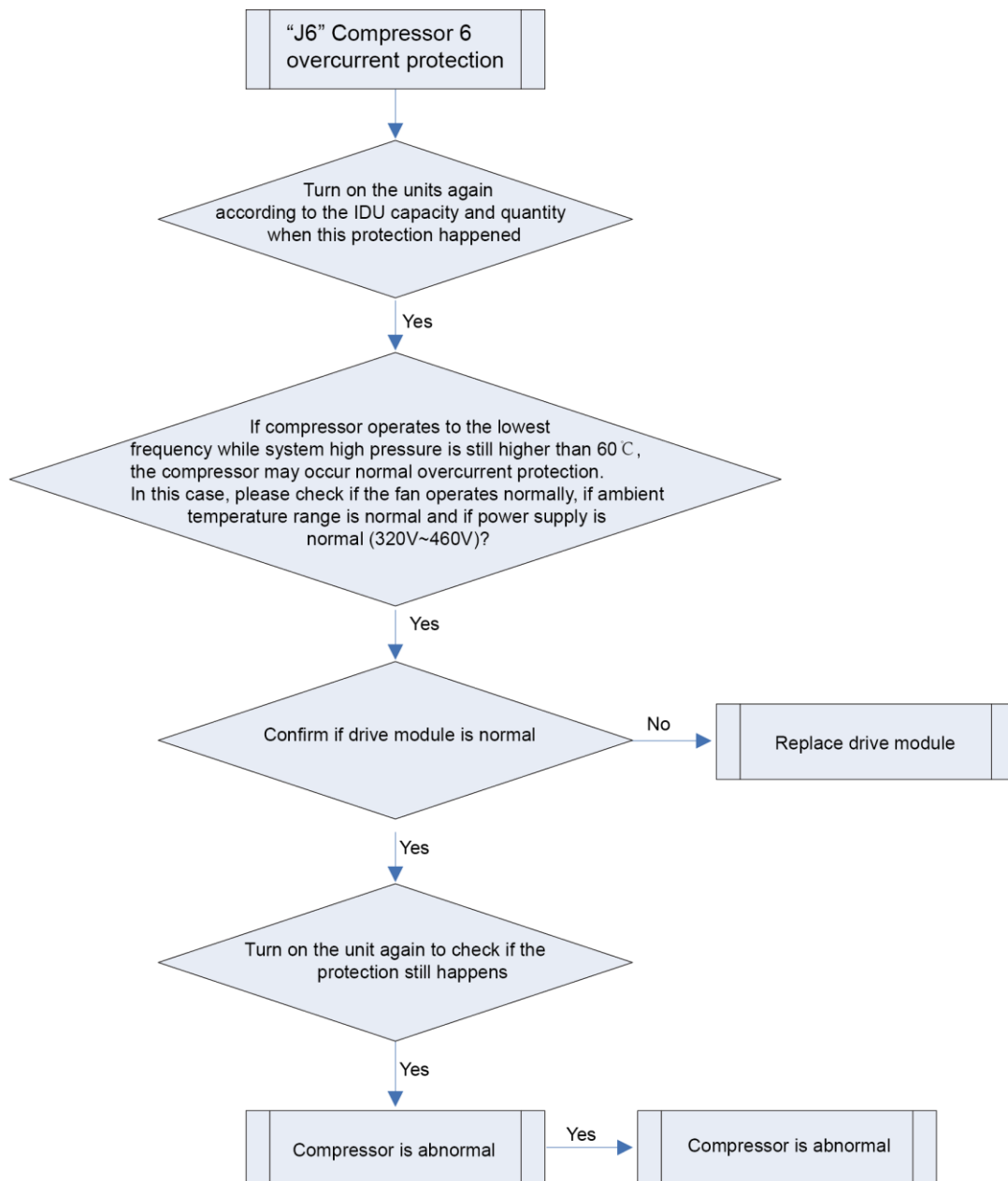

### 2.3.4.95 “J7” Gas-mixing protection of 4-way valve

**Error display:** ODU mainboard, IDU wired controller and IDU receive light board will display



**Error judgment condition and method:** Check the system high pressure and low pressure through pressure sensor. When the difference between system high pressure and low pressure is lower than 0.1MPa after starting operation, the unit will stop for protection.

**Possible reason:**

- Coil or connection wire is abnormal;
- Mainboard is abnormal;
- Internal part of 4-way valve is abnormal;

**Troubleshooting:**

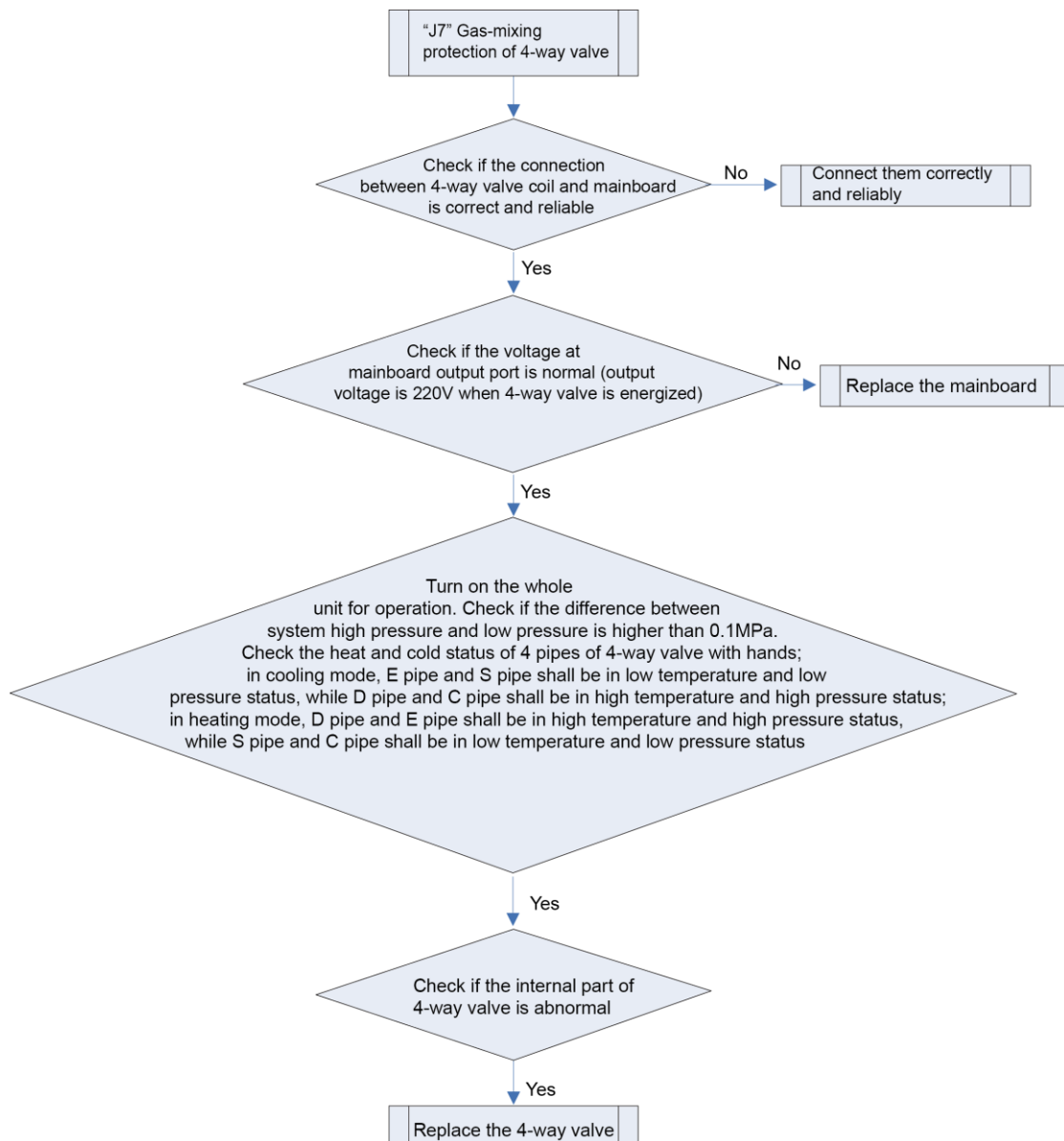

### 2.3.4.96 “J8” System high pressure ratio protection

**Error display:** ODU mainboard, IDU wired controller and IDU receive light board will



**Error judgment condition and method:**

Check the system high pressure and low pressure through pressure sensor. When the ratio between system high pressure and low pressure is bigger than 8 after starting operation, the unit will stop for protection.

**Possible reason:**

- Pressure sensor is abnormal;
- Ambient temperature exceeds the requirement;

**Troubleshooting:**

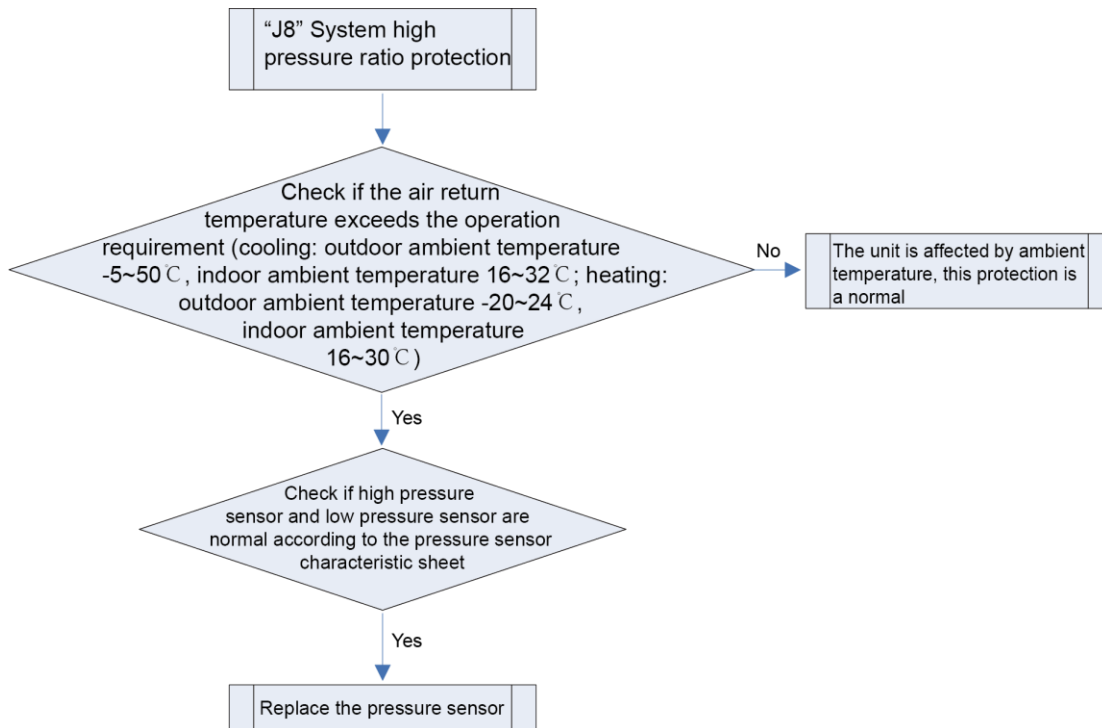

### 2.3.4.97 “J9” System low pressure ratio protection

**Error display:** ODU mainboard, IDU wired controller and IDU receive light board will display



**Error judgment condition and method:**

Check the system high pressure and low pressure through pressure sensor. When the ratio between system high pressure and low pressure is smaller than 1.8 after starting operation, the unit will stop for protection.

**Possible reason:**

- Pressure sensor is abnormal;
- Ambient temperature exceeds the requirement;

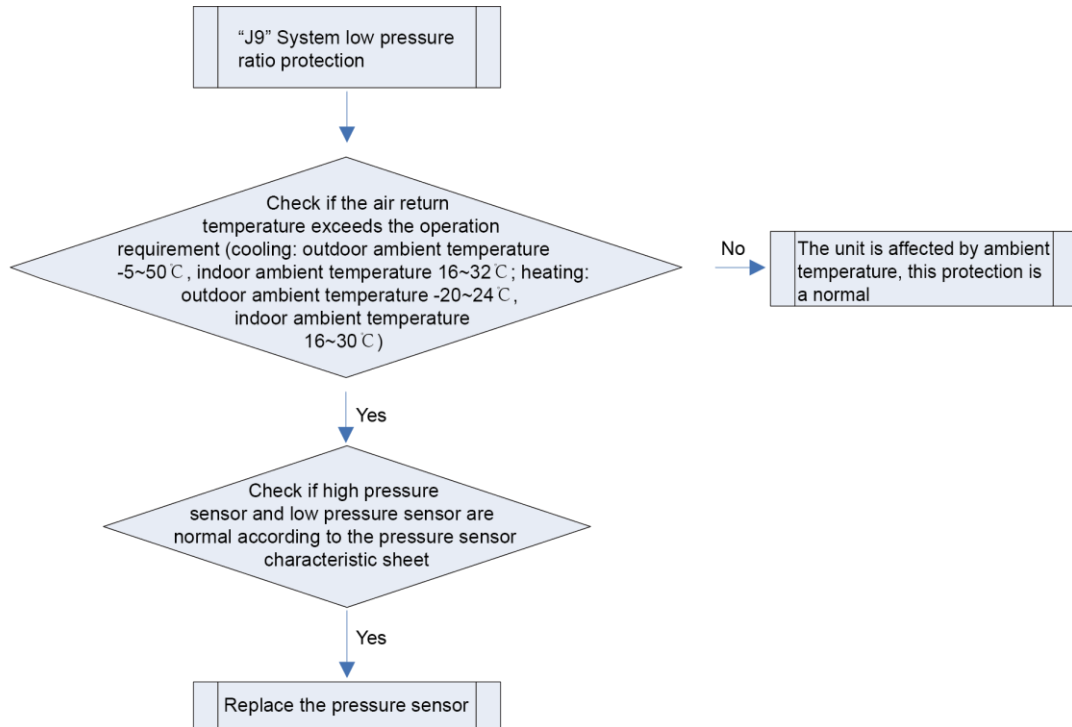

**Troubleshooting:**

## 2.3.4.98 "L1" Indoor fan protection

**Error display:** IDU wired controller and IDU receive light board will display

**Error judgment condition and method:**

Check if the rotation speed of IDU is too slow, or it stops rotation, or protection signal of outdoor fan is transferred. If yes, it is judged that indoor fan protection occurs.

**Possible reason:**

- Motor stops operation or it is blocked
- IDU mainboard is abnormal

**Troubleshooting:**

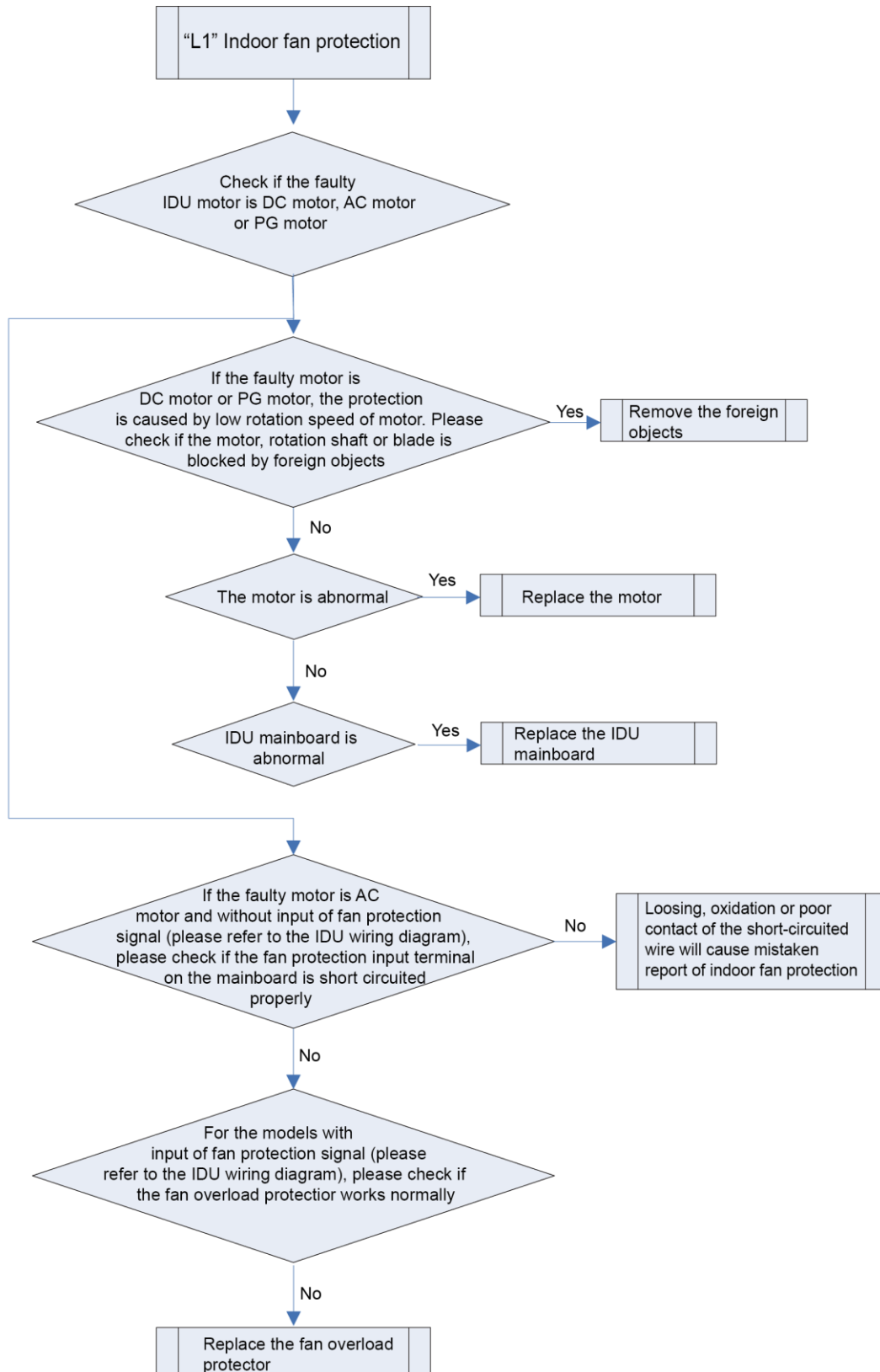

**2.3.4.99 “L3” Water full protection**

**Error display:** IDU wired controller and IDU receive light board will display



**Error judgment condition and method:**

Check the status of IDU float switch. When water level is too high, float switch is activated, so water

full protection happens.

**Possible reason:**

- IDU is installed improperly
- Drainage pump is broken
- Float switch operates abnormally
- IDU mainboard is abnormal

**Troubleshooting:**

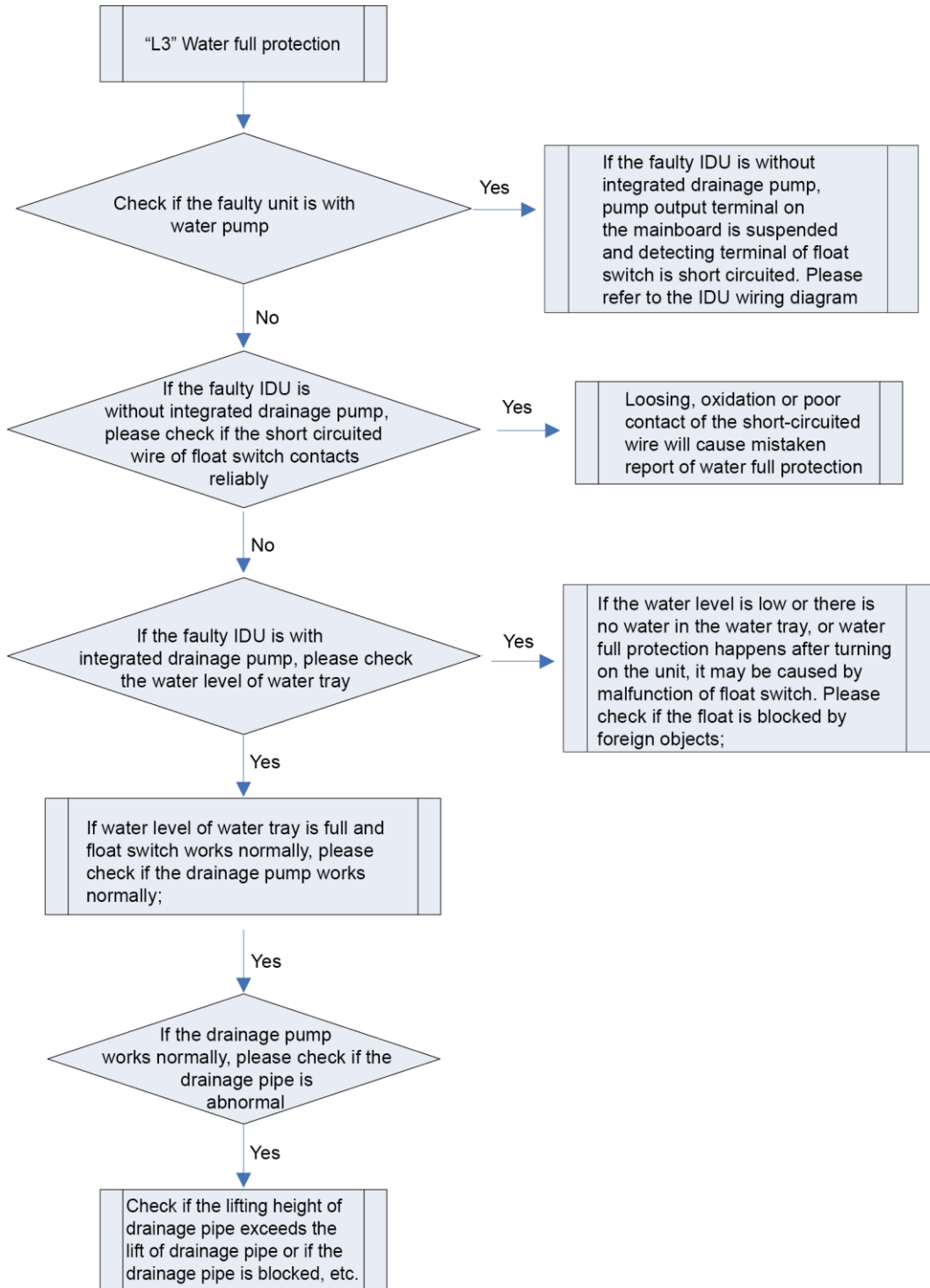

### 2.3.4.100 “L4” Power supply overcurrent protection

**Error display:** IDU wired controller and IDU receive light board will display



**Error judgment condition and method:**

Check if the power supply current from IDU to wired controller is normal. If power supply current is too big, it is judged that the current is abnormal.

**Possible reason:**

- Power supply conducting wire of wired controller is short circuited
- IDU mainboard is abnormal
- Mainboard of wired controller is abnormal

**Troubleshooting:**

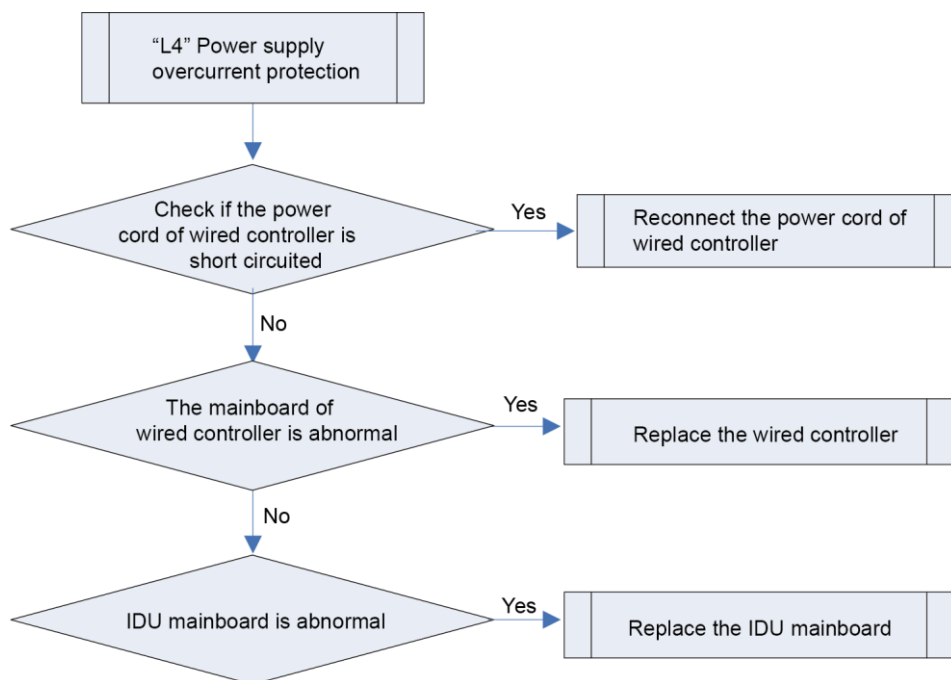

### 2.3.4.101 “L5” Freeze protection

**Error display:** IDU wired controller and IDU receive light board will display



**Error judgment condition and method:**

Check IDU pipe temperature. When pipe temperature is too low, freeze protection will be activated to prevent freezing damage of evaporator.

**Possible reason:**

- IDU filter and evaporator are dirty
- IDU motor is blocked
- Refrigerant amount is insufficient
- Ambient temperature of IDU and ODU is too low

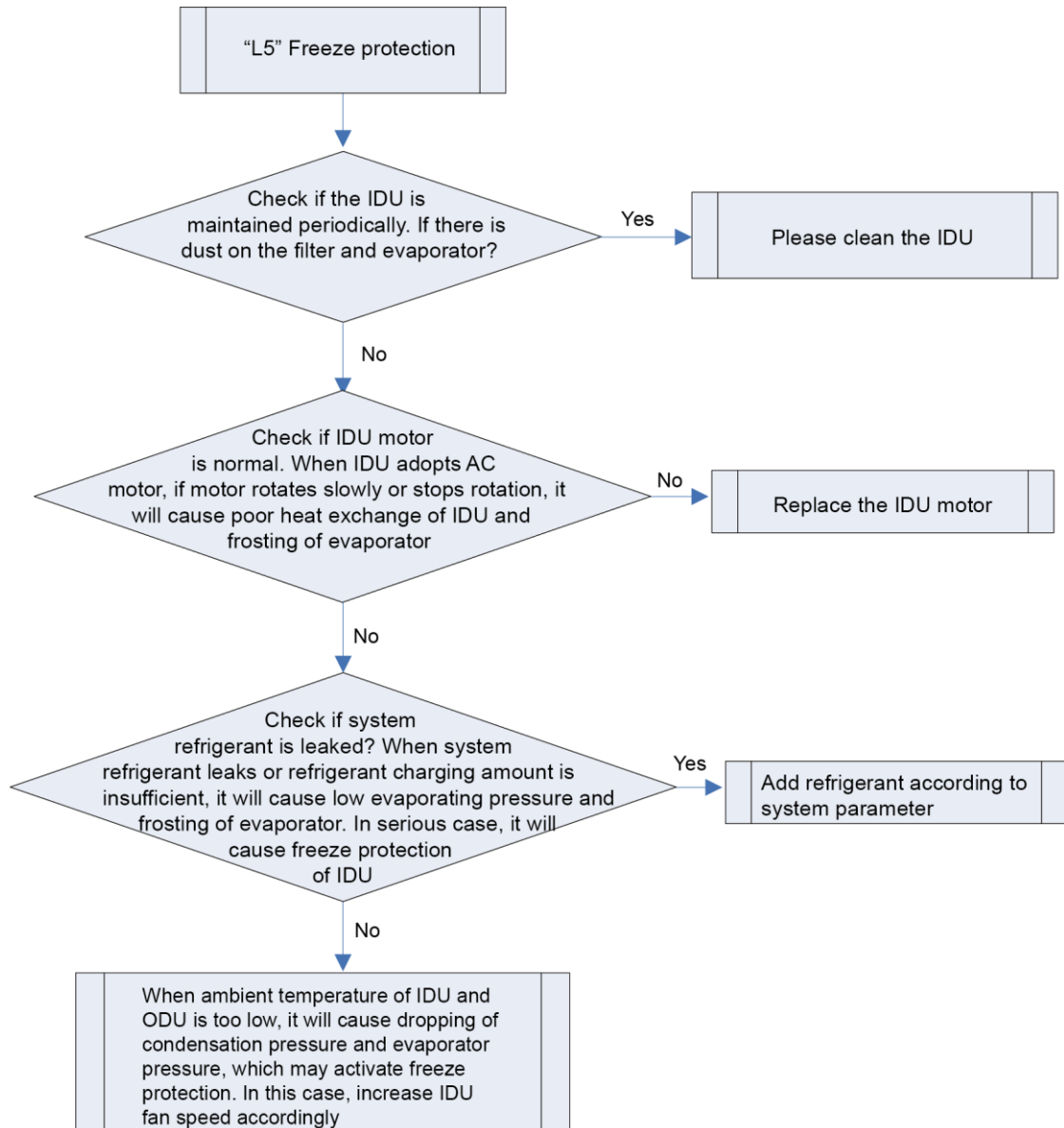
**Troubleshooting:**

## 2.3.4.102 "L7" No master IDU

**Error display:** IDU wired controller and IDU receive light board will display

**Error judgment condition and method:**

No master IDU error will happen when there is no master IDU in the system

**Possible reason:**

- Master IDU is offline
- The mainboard of master IDU is replaced
- The mainboard of master IDU has error

**Troubleshooting:**

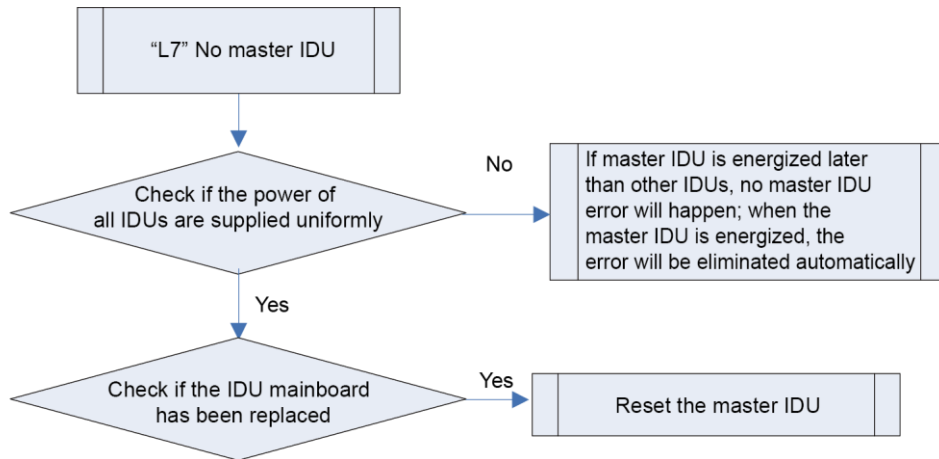

2.3.4.103 “L9” Group-controlled IDU quantity inconsistency

**Error display:** IDU wired controller and IDU receive light board will display



**Error judgment condition and method:**

If the IDU quantity connected with wired controller exceeds 16 sets or actually connected IDU quantity is inconsistent with the set group-controlled IDU quantity.

**Possible reason:**

- IDU quantity connected with one wired controller exceeds 16 sets;
- Actually connected IDU quantity is inconsistent with the set group-controlled IDU quantity.

**Troubleshooting:**

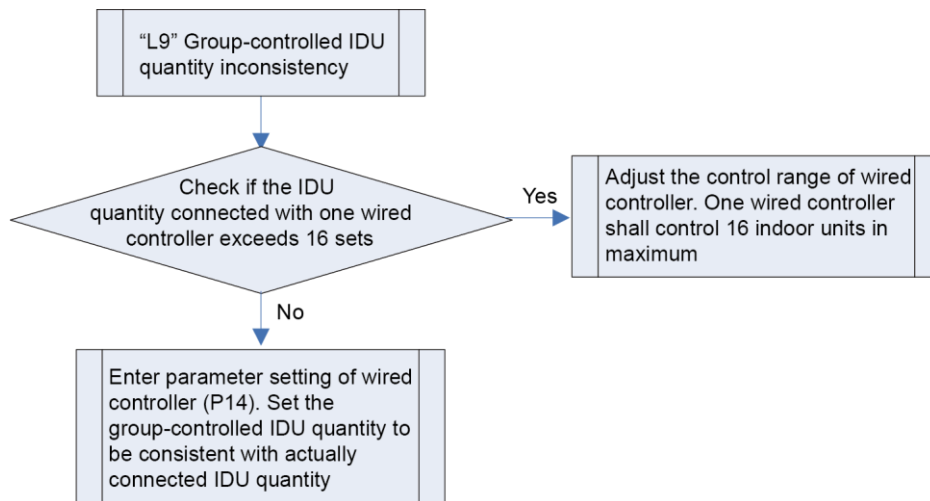

2.3.4.104“LA” Group-controlled IDU series inconsistency

**Error display:** IDU wired controller and IDU receive light board will display



**Error judgment condition and method:**

Wired controller detects that the IDUs connected with itself belong to different series.

**Possible reason:**

- IDUs connected with one wired controller belong to different series.

**Troubleshooting:**

Make sure the IDUs connected with one wired controller belong to the same series.

#### 2.3.4.105 “LC” Mismatch of IDU and ODU models

**Error display:** IDU wired controller and IDU receive light board will display



**Error judgment condition and method:**

When some IDUs or devices which cannot be identified by some ODU are installed in the system, mismatch error of IDU and ODU models will occur.

**Possible reason:**

- Mismatch of IDU and ODU

**Troubleshooting:**

When some IDUs or devices which cannot be identified by some ODU are installed in the system (E.g. floor heating device is installed in modular DC inverter multiple VRF system), the error will occur. Please remove the relevant IDU devices or replace the ODU with suitable model.

#### 2.3.4.106 “n0” System energy-saving operation setting status

**Error display:** ODU mainboard, IDU wired controller and IDU receive light board will display



**Error judgment condition and method:**

This code is function setting status code, which indicates that the system has entered energy-saving setting status. “00” is the control with priority of comfort; “01” is the control with priority of energy savings, in which energy savings can reach 15%.

**Possible reason:** ——

**Troubleshooting:** status code, no troubleshooting.

#### 2.3.4.107 “n2” Upper limit setting status of IDU&ODU capacity configuration ratio

**Error display:** ODU mainboard, IDU wired controller and IDU receive light board will display



**Error judgment condition and method:**

This code is function setting status code, which indicates that the system has entered upper limit setting status of IDU&ODU capacity configuration ratio.

**Possible reason:** ——

**Troubleshooting:** status code, no troubleshooting.

#### 2.3.4.108 “n4” Limit setting status of max output capacity

**Error display:** ODU mainboard, IDU wired controller and IDU receive light board will display



**Error judgment condition and method:**

This code is function setting status code, which indicates that the system has entered the limit setting status of max output capacity. “10” means max output capacity is 100%; “09” means max output capacity is 90%; “08” means max output capacity is 80%.

**Possible reason:** ——

**Troubleshooting:** status code, no troubleshooting.

## 2.3.4.109 “n6” Unit error inquiry status

**Error display:** ODU mainboard, IDU wired controller and IDU receive light board will display

**Error judgment condition and method:**

This code is the inquiry status code, which indicates that the system has entered the unit error inquiry status. In this case, 5 history errors of IDU and ODU can be inquired. Pay attention that IDU error and ODU error shall be inquired separately.

**Possible reason:** ——

**Troubleshooting:** status code, no troubleshooting.

## 2.3.4.110 “n7” Unit parameter inquiry status

**Error display:** ODU mainboard, IDU wired controller and IDU receive light board will display

**Error judgment condition and method:**

This code is the inquiry status code, which indicates that the system has entered the unit parameter inquiry status.

**Possible reason:** ——

**Troubleshooting:** status code, no troubleshooting.

## 2.3.4.111 “n8” IDU project code inquiry status

**Error display:** IDU wired controller will display

**Error judgment condition and method:**

This code is the inquiry status code, which indicates that the system has entered the IDU project code inquiry status. After entering this function, wired controller will display the project code of this IDU. Meanwhile, the IDU buzzer will beep.

**Possible reason:** ——

**Troubleshooting:** status code, no troubleshooting.



#### 2.3.4.112 “n9” Online IDU quantity inquiry status

**Error display:** ODU mainboard will display



**Error judgment condition and method:**

This code is the inquiry status code. In this case, online IDU quantity can be inquired.

**Possible reason:** ——

**Troubleshooting:** status code, no troubleshooting.

#### 2.3.4.113 “nA” Heat pump unit

**Error display:** ODU mainboard will display



**Error judgment condition and method:**

This code is the heating only model status code, which indicates that the system has been set to heating only unit status. The IDUs can operate in heating mode and cooling mode.

**Possible reason:** ——

**Troubleshooting:** status code, no troubleshooting.

#### 2.3.4.114 “nH” Heating only model status

**Error display:** ODU mainboard will display



**Error judgment condition and method:**

This code is the heating only model status code, which indicates that the system has been set to heating only unit status. The IDUs can only operate in heating mode.

**Possible reason:** ——

**Troubleshooting:** status code, no troubleshooting.

#### 2.3.4.115 “nC” Cooling only model status

**Error display:** ODU mainboard will display



**Error judgment condition and method:**

This code is the heating only model status code, which indicates that the system has been set to heating only unit status. The IDUs can only operate in cooling mode.

**Possible reason:** ——

**Troubleshooting:** status code, no troubleshooting.

#### 2.3.4.116 “nE” Negative number code

**Error display:** ODU mainboard will display



**Error judgment condition and method:**

This code is the negative sign, which indicates that the followed displayed data is negative number.

**Possible reason:** ——

**Troubleshooting:** status code, no troubleshooting.

#### 2.3.4.117 “nF” Fan only model status

**Error display:** ODU mainboard will display



**Error judgment condition and method:**

This code is the fan only model status code, which indicates that the system has been set to fan only unit status. The IDUs can only operate in fan mode.

**Possible reason:** ——

**Troubleshooting:** status code, no troubleshooting.

#### 2.3.4.118 “P0” Compressor drive board error

**Error display:** IDU wired controller will display



**Error judgment condition and method:**

Check error code through IDU wired controller. If IDU wired controller displays P0, please also check the error code displayed on the nixie tube of ODU main control board. Detailed error of compressor drive board can be judged according to the error code on main control board. Then arrange troubleshooting accordingly.

**Possible reason:**

■ Compressor drive module reset protection (P3 is displayed on the nixie tube of ODU main control board)

■ Compressor drive temperature sensor error (P7 is displayed on the nixie tube of ODU main control board)

■ Compressor drive IPM high temperature protection (P8 is displayed on the nixie tube of ODU main control board)

■ Compressor drive current detecting circuit error (PC is displayed on the nixie tube of ODU main control board)

■ Compressor drive charging circuit error (PF is displayed on the nixie tube of ODU main control board)

■ Inverter compressor non-synchronism protection (P9 is displayed on the nixie tube of ODU main control board)

■ Inverter compressor startup failure (PJ is displayed on the nixie tube of ODU main control board)

**Troubleshooting:**

Find out corresponding solution according to the error code displayed on ODU mainboard.

#### 2.3.4.119 “P1” Compressor drive board operation error

**Error display:** IDU wired controller will display



**Error judgment condition and method:**

Check error code through IDU wired controller. If IDU wired controller displays P1, please also check the error code displayed on the nixie tube of ODU main control board. Detailed error of compressor drive board can be judged according to the error code on main control board. Then arrange troubleshooting accordingly.

**Possible reason:**

- Inverter compressor overcurrent protection (P5 is displayed on the nixie tube of ODU main control board)
- Compressor drive IPM module protection (P6 is displayed on the nixie tube of ODU main control board)
- Compressor drive communication error (C2 is displayed on the nixie tube of ODU main control board)

**Troubleshooting:**

Find out corresponding solution according to the error code displayed on ODU mainboard.

**2.3.4.120 “P2” Voltage protection of driving board power of compressor**

**Error display:** IDU wired controller will display

**Error judgment condition and method:**

Check error code through IDU wired controller. If IDU wired controller displays P2, please also check the error code displayed on the nixie tube of ODU main control board. Detailed error of compressor drive board can be judged according to the error code on main control board. Then arrange troubleshooting accordingly.

**Possible reason:**

- High voltage protection of compressor drive DC bus (PH is displayed on the nixie tube of ODU main control board)
- Low voltage protection of compressor drive DC bus (PL is displayed on the nixie tube of ODU main control board)

**Troubleshooting:**

Find out corresponding solution according to the error code displayed on ODU mainboard.

**2.3.4.121 “P3” Compressor drive module reset protection**

**Error display:** ODU mainboard will display

**Error judgment condition and method:**

Check the error code on nixie tube of ODU main control board. If P3 is displayed, it indicates compressor drive board module reset protection

**Possible reason:**

- Compressor drive board is abnormal

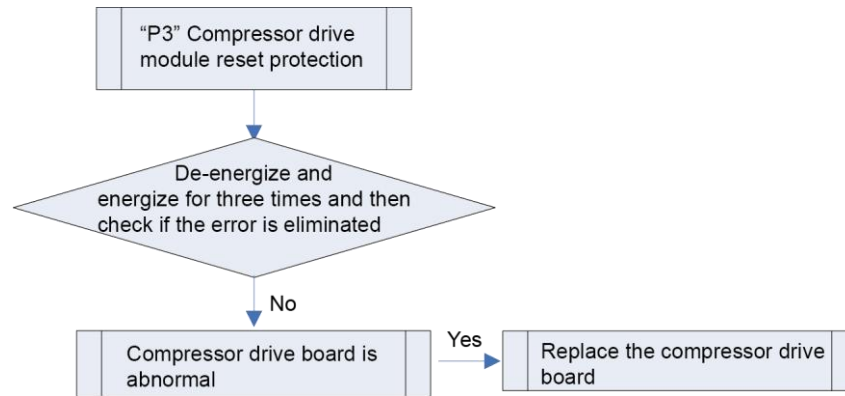
**Troubleshooting:**

## 2.3.4.122 “P5” Inverter compressor overcurrent protection

**Error display:** ODU mainboard will display

**Error judgment condition and method:**

Check the error code on nixie tube of ODU main control board. If P5 is displayed, it indicates inverter compressor overcurrent protection

**Possible reason:**

- Poor contact of compressor UVW wire;
- Connection sequence of compressor UVW wire is wrong;
- Compressor is broken;
- System is blocked;
- Compressor drive board IPM module is broken.

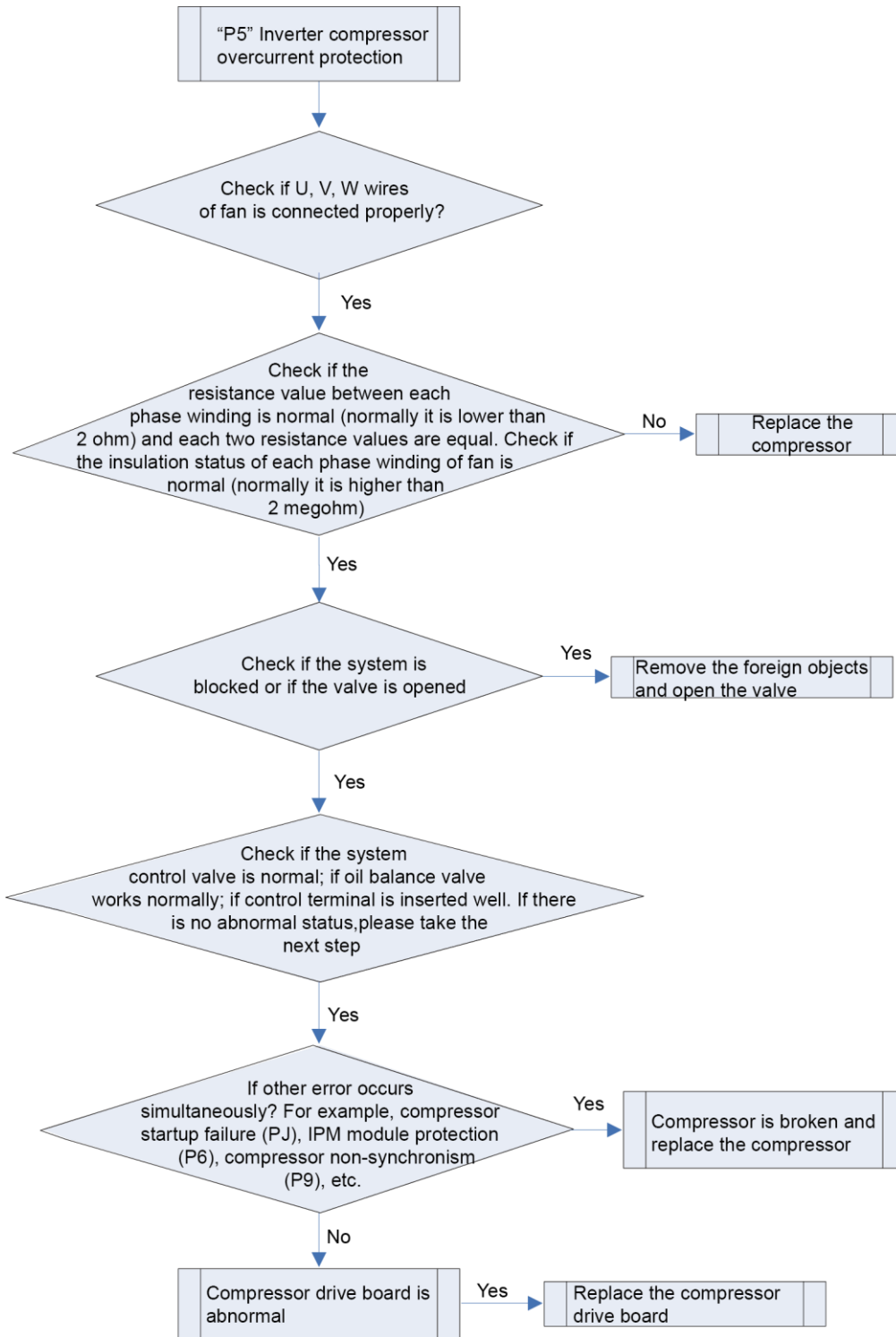
**Troubleshooting:**

## 2.3.4.123 “P6” Inverter compressor IPM protection

**Error display:** ODU mainboard will display



**Error judgment condition and method:**

Check the error code on nixie tube of ODU main control board. If P6 is displayed, it indicates inverter compressor overcurrent protection

**Possible reason:**

- Poor contact of compressor UVW wire;
- Connection sequence of compressor UVW wire is wrong;
- Compressor is broken;
- System is blocked;
- Compressor drive board IPM module is broken.

**Troubleshooting:**

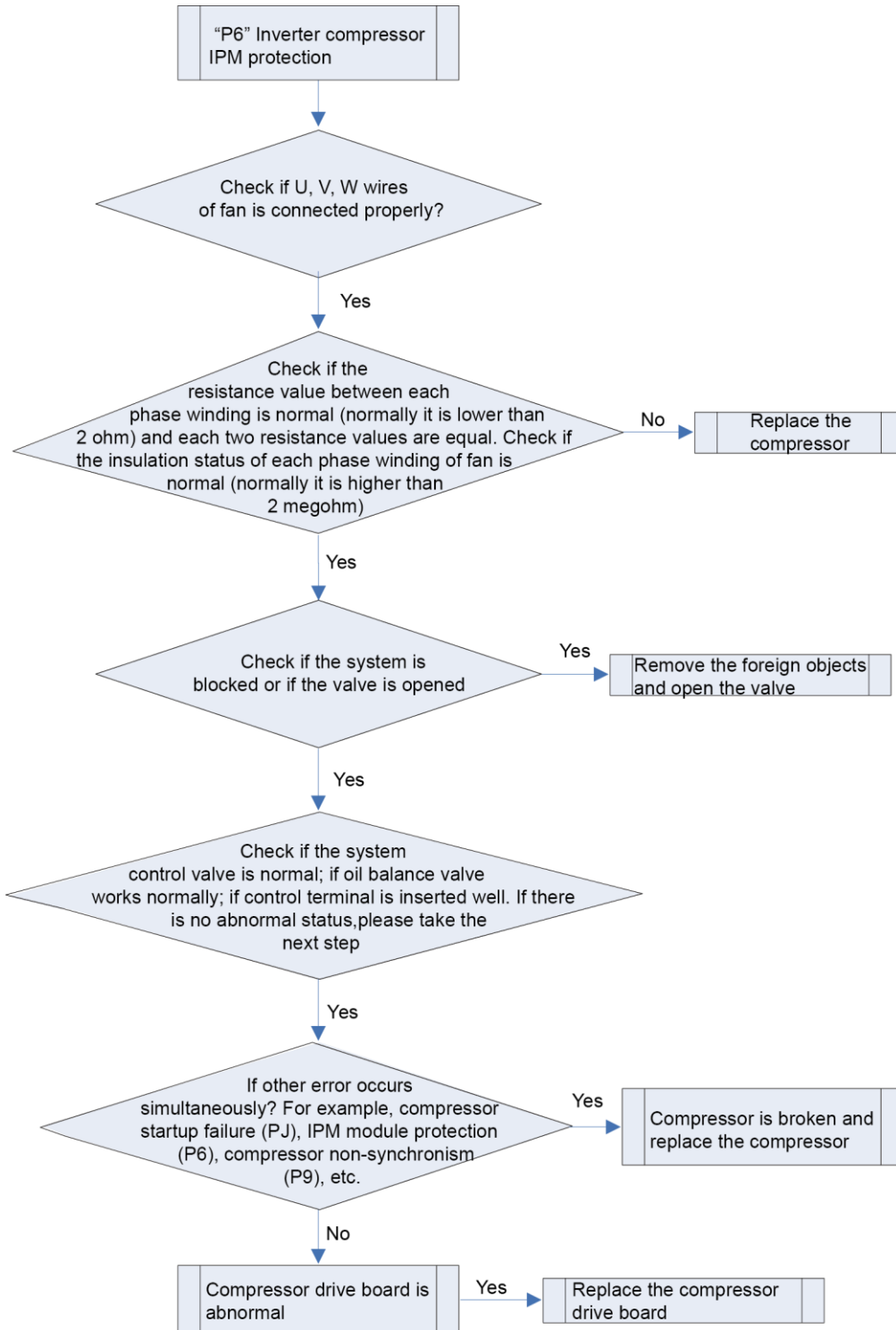

2.3.4.124 “P7” Compressor drive board temperature sensor error

**Error display:** ODU mainboard will display



**Error judgment condition and method:**

Check the error code on nixie tube of ODU main control board. If P7 is displayed, it indicates compressor drive board temperature sensor error

**Possible reason:**

- Compressor drive board is abnormal

**Troubleshooting:**

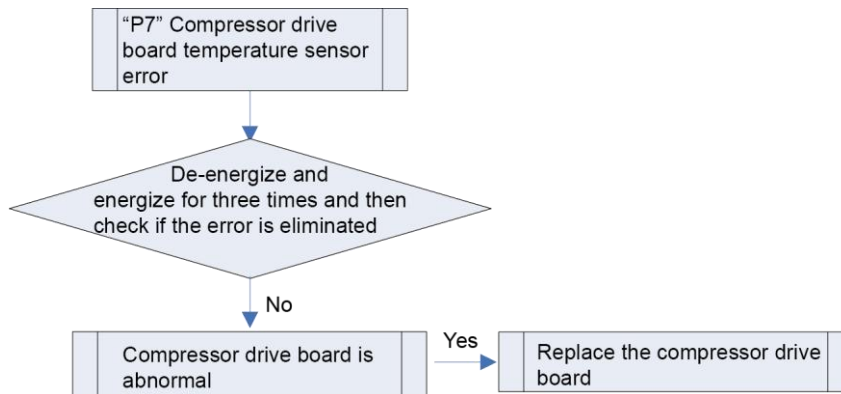

2.3.4.125 “P8” Compressor drive IPM high temperature protection

**Error display:** ODU mainboard will display



**Error judgment condition and method:**

Check the error code on nixie tube of ODU main control board. If P8 is displayed, it indicates compressor drive board IPM high temperature protection occurs

**Possible reason:**

- Screw of IPM module is not tightened;
- Thermal grease of IPM module hasn't been spread or thermal grease is not spread evenly or thermal grease is dry;
- Fan drive board is abnormal;

**Troubleshooting:**

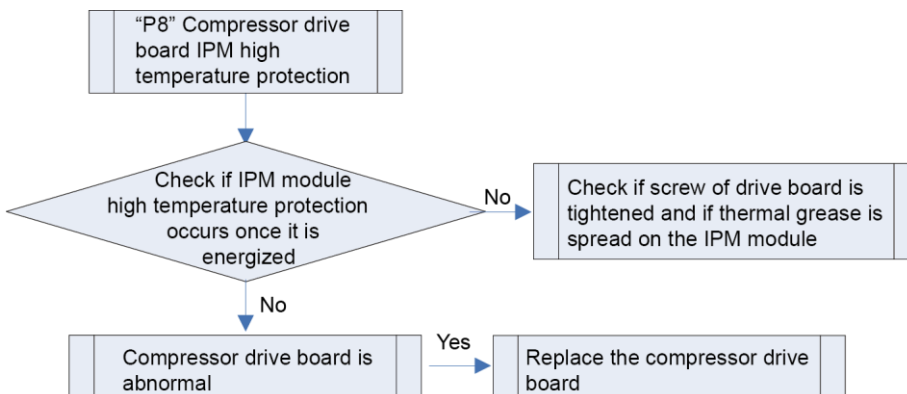

#### 2.3.4.126 “P9” Desynchronizing protection of inverter compressor.

**Error display:** ODU mainboard will display



**Error judgment condition and method:**

Check the error code on nixie tube of ODU main control board. If P9 is displayed, it indicates Desynchronizing protection of inverter compressor.

**Possible reason:**

- Compressor is broken;
- Fan drive board is abnormal;



Troubleshooting:

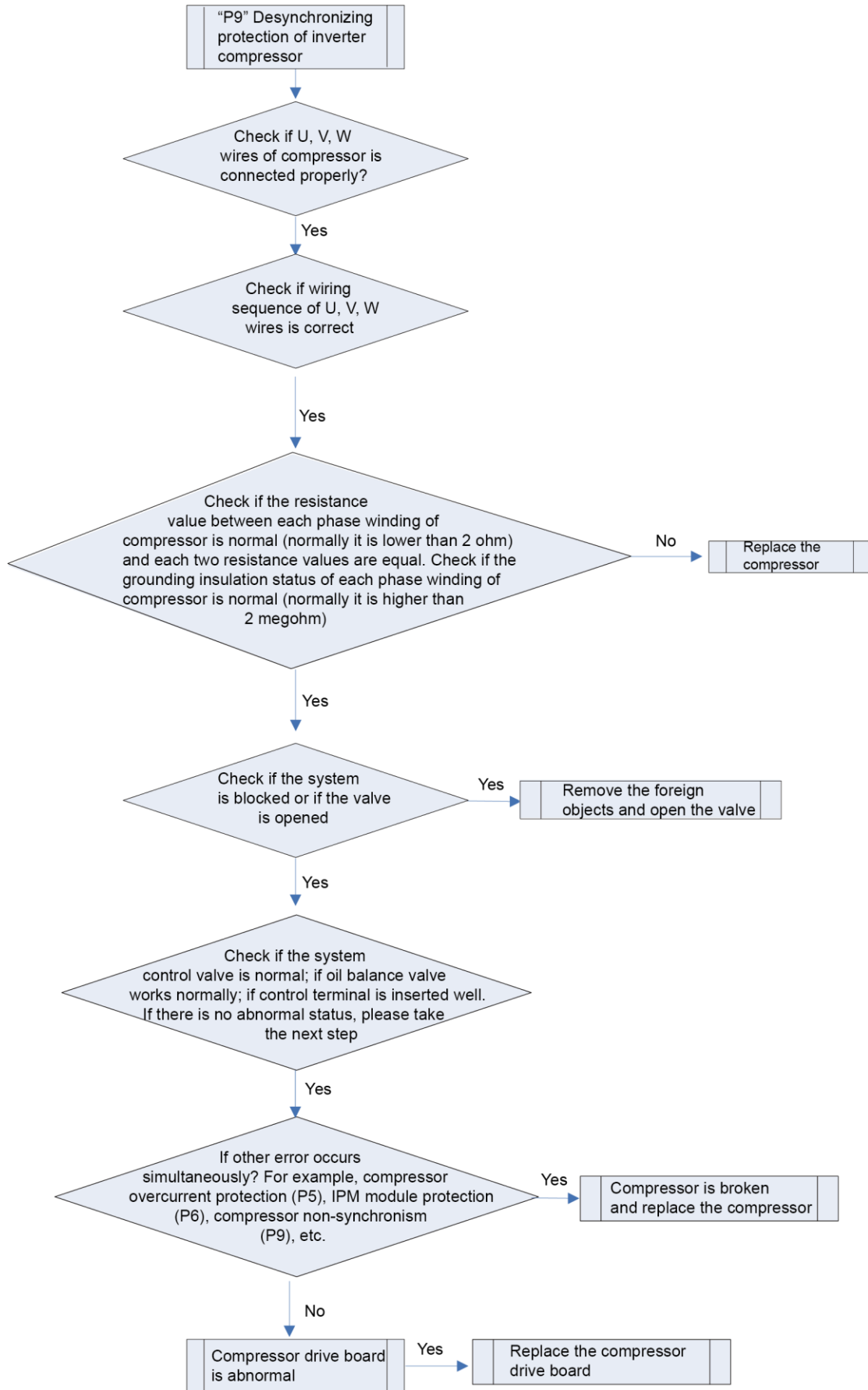

## 2.3.4.127 “PC” Compressor drive current detecting circuit error

**Error display:** ODU mainboard will display



**Error judgment condition and method:**

Check the error code on nixie tube of ODU main control board. If PC is displayed, it indicates compressor drive current detecting circuit error

**Possible reason:**

- Compressor drive board is abnormal

**Troubleshooting:**

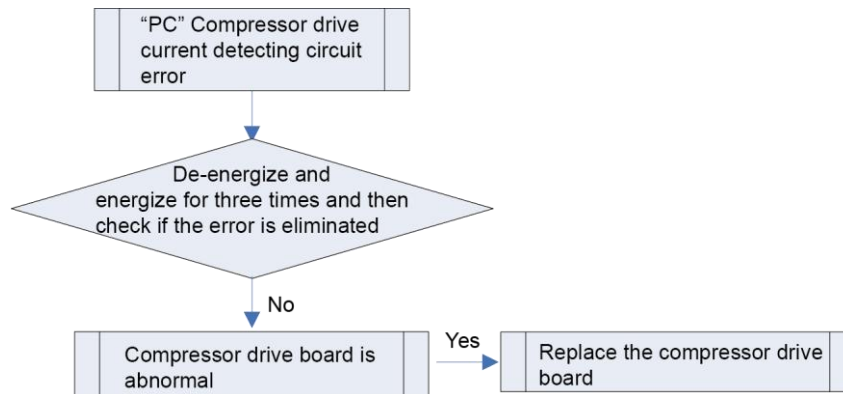

## 2.3.4.128 “PH” Compressor drive DC bus high voltage protection

**Error display:** ODU mainboard will display



**Error judgment condition and method:**

If the mainboard detects that input power cord voltage exceeds 460V, it will report high voltage protection.

**Possible reason:**

- Power supply voltage is higher than 460V;
- Compressor drive board is abnormal.

**Troubleshooting:**

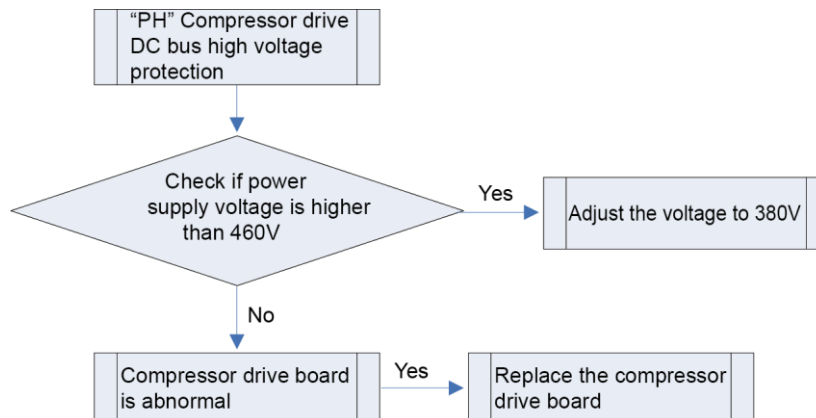

### 2.3.4.129 “PL” Compressor drive DC bus low voltage protection

**Error display:** ODU mainboard will display



**Error judgment condition and method:**

If the mainboard detects that input power cord voltage is lower than 320V, it will report low voltage protection.

**Possible reason:**

- Power supply voltage is lower than 320V;
- Compressor drive board is abnormal.

**Troubleshooting:**

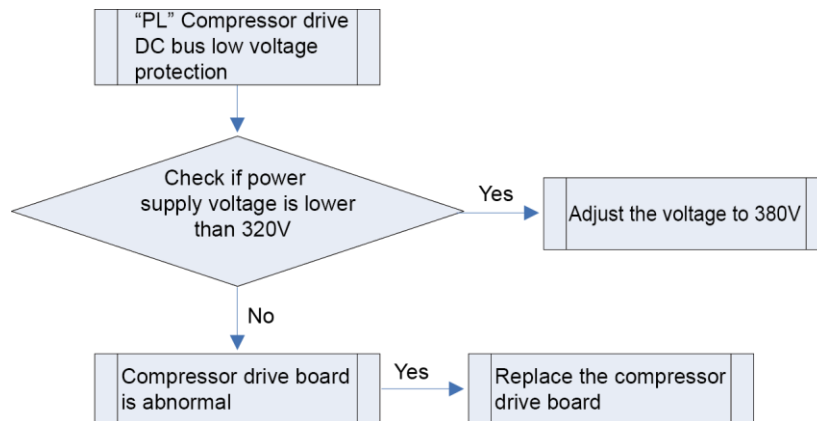

### 2.3.4.130 “PJ” Inverter compressor startup failure

**Error display:** ODU mainboard will display



Check the error code on nixie tube of ODU main control board. If PJ is displayed, it indicates inverter compressor startup failure

- Poor contact of compressor UVW wire;
- Compressor is broken;
- Compressor drive board is broken;

Troubleshooting:

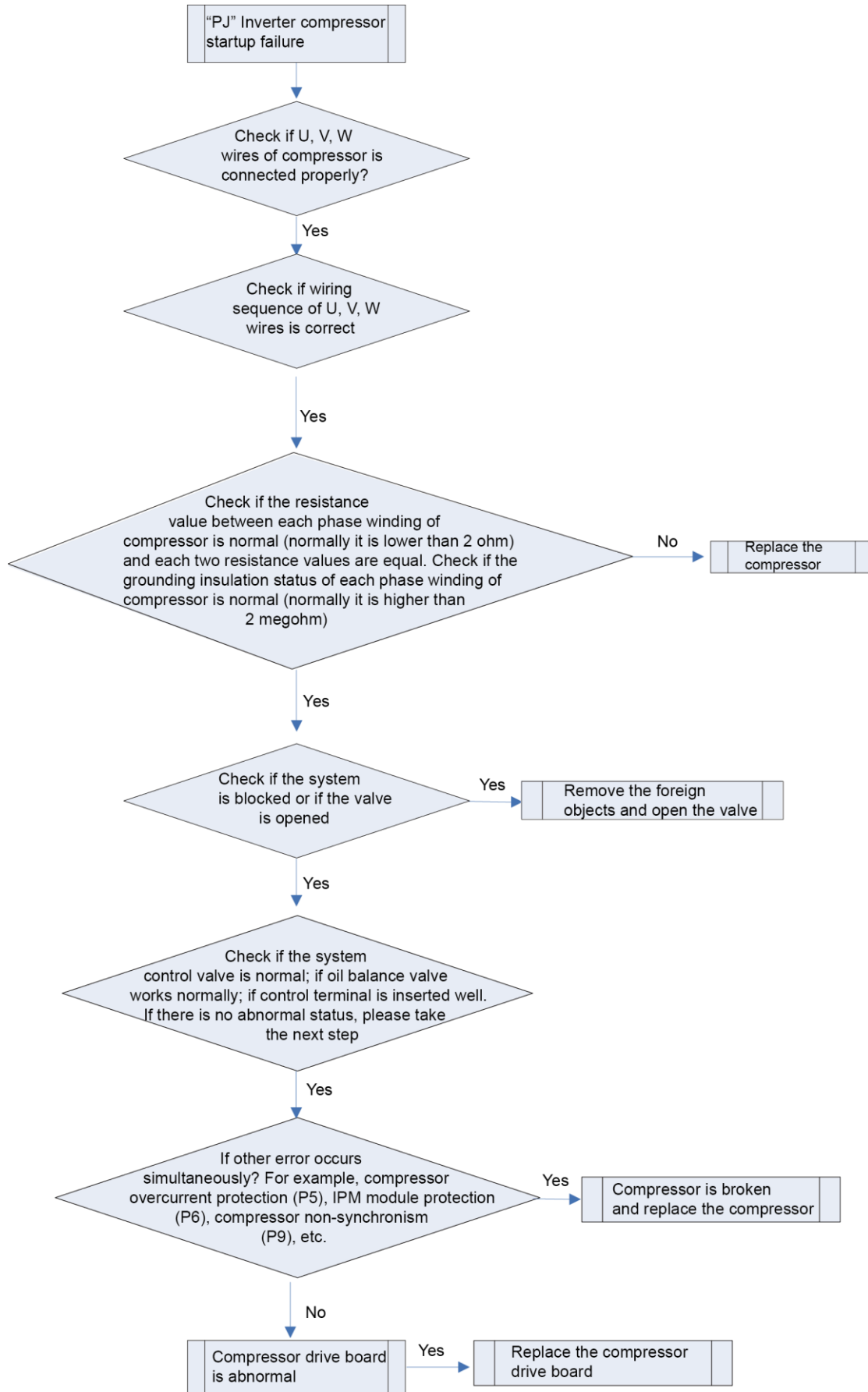

### 2.3.4.131 “U0” Insufficient compressor preheating time

**Error display:** ODU mainboard, IDU wired controller and IDU receive light board will

display 

**Error judgment condition and method:**

If it is detected that the oil temperature preheating time of compressor before startup doesn't reach 8 hours, it will report this error.

**Possible reason:** ——

**Troubleshooting:**

The complete unit shall be preheated for more than 8 hours before startup.

### 2.3.4.132 “U2” ODU capacity DIP switch/jumper cap setting error

**Error display:** ODU mainboard, IDU wired controller and IDU receive light board will

display 

**Error judgment condition and method:**

ODU mainboard detects that the capacity code doesn't comply with the actual unit capacity, or ODU mainboard detects that the jumper cap value doesn't comply with the actual unit

**Possible reason:**

- Capacity DIP switch is wrong or jumper cap is wrong (for those models without jumper cap, it won't be detected)

- DIP switch or jumper cap is broken

- Detecting circuit is abnormal

**Troubleshooting:**

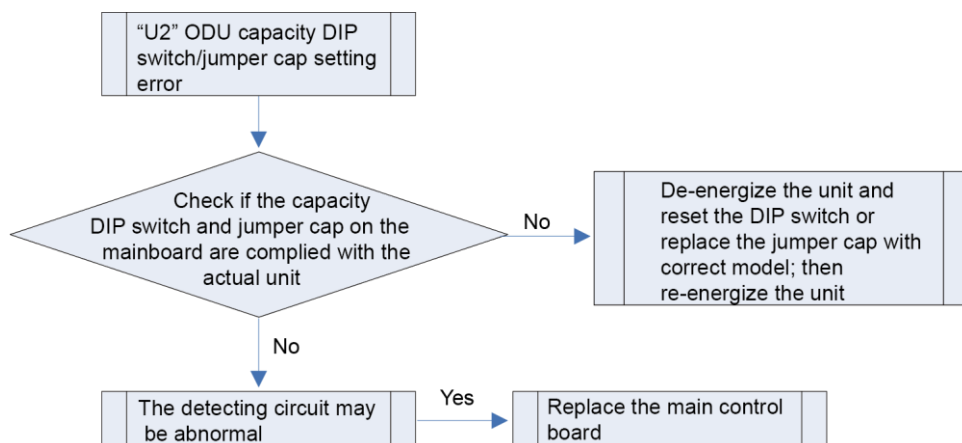

### 2.3.4.133 “U3” Power phase sequence protection

**Error display:** ODU mainboard, IDU wired controller and IDU receive light board will

display 

**Error judgment condition and method:**

If phase loss or reverse of three-phase power is detected (e.g. incorrect connection of power supply

causes phase loss or reverse), it will report this error

**Possible reason:**

- The power supply connected to the unit is incorrect, phase loss or reverse happens
- Detecting circuit is abnormal

**Troubleshooting:**

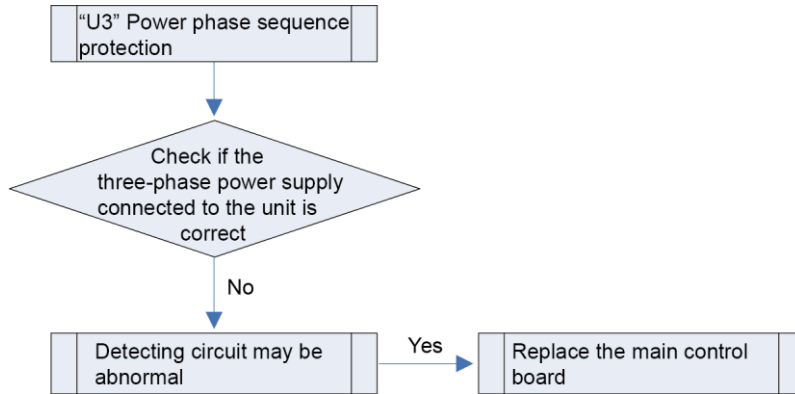

2.3.4.134 “U4” Lack of refrigerant protection

**Error display:** ODU mainboard, IDU wired controller and IDU receive light board will



**Error judgment condition and method:**

Check the system high pressure and low pressure through pressure sensor. When the system high pressure and low pressure is lower than 5 of outdoor ambient temperature before starting operation, the unit will stop for protection.

**Possible reason:**

- Refrigerant charging amount is insufficient;
- System pipeline is leaked;

**Troubleshooting:**

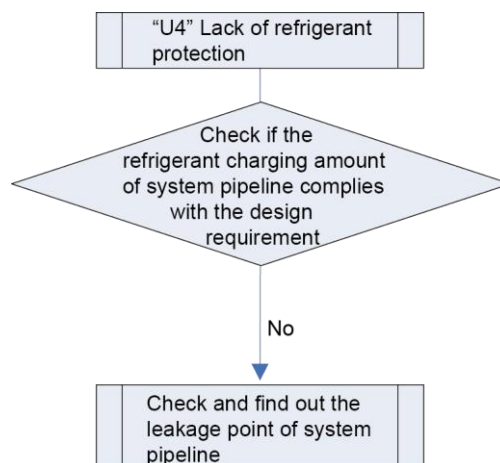

2.3.4.135 “U6” Valve error

**Error display:** ODU mainboard, IDU wired controller and IDU receive light board will



**Error judgment condition and method:**

During commissioning, check if ODU cut-off valve is opened through detecting system parameter by pressure sensor. If the parameter is abnormal, it will indicate that confirming the open of cut-off valve and then press SW5 to enter the next step after confirming.

**Possible reason:**

- ODU cut-off valve is not opened;

**Troubleshooting:**

Confirm again and open ODU cut-off valve.

## 2.3.4.136 “U8” IDU pipeline error

**Error display:** ODU mainboard, IDU wired controller and IDU receive light board will

display 

**Error judgment condition and method:**

During commissioning, check if IDU pipeline is blocked through detecting IDU pipeline. If the parameter is abnormal, it will indicate t

**Possible reason:**

- Electronic expansion valve doesn't operate normally;
- IDU pipeline is blocked;

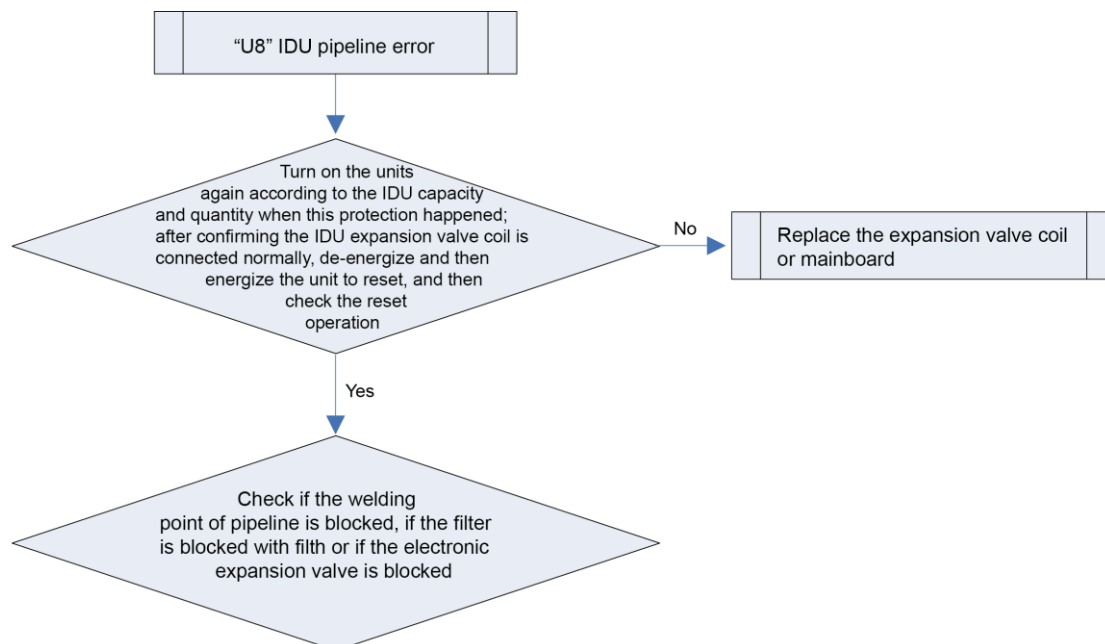
**Troubleshooting:**

## 2.3.4.137 “U9” ODU pipeline error

**Error display:** ODU mainboard, IDU wired controller and IDU receive light board will

display 

**Error judgment condition and method:**

During commissioning, check if ODU pipeline is blocked through detecting system pressure. If the

parameter is abnormal, it will indicate this error.

**Possible reason:**

- Electronic expansion valve doesn't operate normally;
- ODU pipeline is blocked;

**Troubleshooting:**

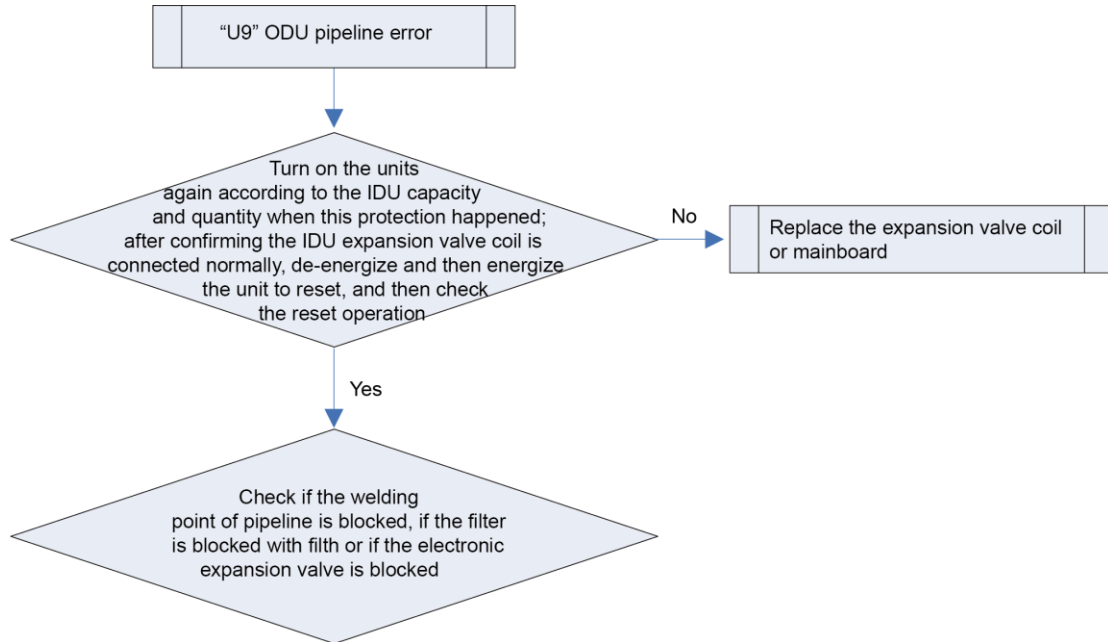

#### 2.3.4.138 "UC" Setting of master IDU is done

**Error display:** ODU mainboard, IDU wired controller and IDU receive light board will



**Error judgment condition and method:**

This code is status code, not an error. During commissioning, it indicates that setting of master IDU is done.

**Possible reason:** ——

**Troubleshooting:** ——

#### 2.3.4.139 "UL" Compressor emergency operation DIP switch error

**Error display:** ODU mainboard, IDU wired controller and IDU receive light board will



**Error judgment condition and method:**

If setting of compressor emergency operation DIP switch is not within the setting range, it will indicate this error.

**Possible reason:** ——

**Troubleshooting:**

Reset the DIP switch according to relevant sheet.



#### 2.3.4.140 “UE” auto charging of refrigerant is invalid

**Error display:** ODU mainboard, IDU wired controller and IDU receive light board will



**Error judgment condition and method:**

When outdoor ambient temperature exceeds the temperature range of auto charging of refrigerant (normal temperature range is 0~40°C), the unit will report this error.

**Possible reason:** ——

**Troubleshooting:**

Cancel auto charging of refrigerant and change to manual charging of refrigerant.

#### 2.3.4.141 Poor cooling and heating performances

**Error judgment condition and method:**

1. When electronic expansion valve is opened to 2000PLS in cooling operation of IDU and IDU coil outlet pipe temperature is 5°C higher than inlet pipe temperature;

2. When electronic expansion valve is opened to 2PLS in heating operation of IDU and IDU coil outlet pipe temperature is 12°C lower than saturated temperature corresponding to high pressure;

**Possible reason:**

- ODU cut-off valve is opened to the max flow without following the requirement.
- System pipeline is blocked.
- Operation environment exceeds the range.
- Flow organization design is not good.
- Refrigerant charging amount is insufficient.

**Troubleshooting:**

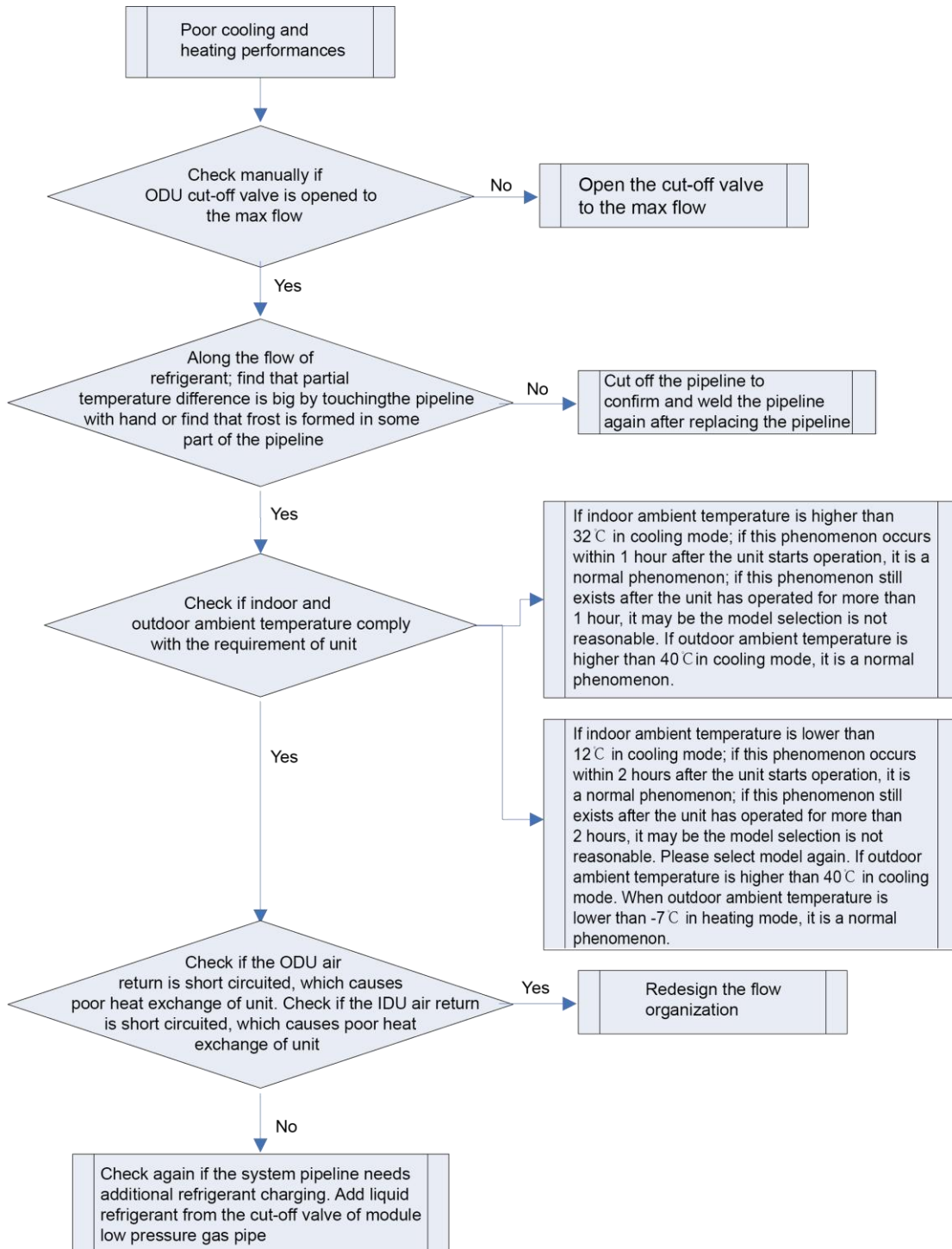

# 3 KEY PARTS MAINTENANCE

## 3.1 CAUTIONS ON CONTROLLER AP1 REPLACEMENT

### 3.1.1 Cautions on ODU AP1 Replacement

#### 3.1.1.1 Distinguishing Master Module from Slave Module

Before replacing ODU AP1, determine the module is a master ODU or a slave ODU. They can be distinguished based on:

(1) "Master module DIP state (SA8\_MASTER-S)"

Every cooling system has only one master module (set in power-off state). When a DIP is "ON", the corresponding position is "0"; when the DIP is "OFF", the corresponding position is "1". If SA8\_MASTER-S is set to "00", it indicates a master module; if it is set to "10", it indicates a slave module (as shown in the figure below).

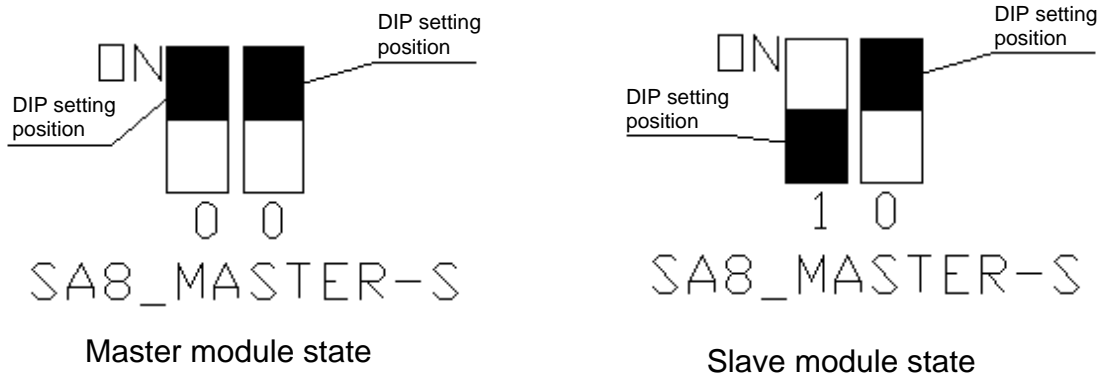

(2) AP1 LED

When a master module is powered on, LED1 is displayed as "01". For a slave module, LED1 is displayed as "02", "03" or "04" (as shown in the figure below).

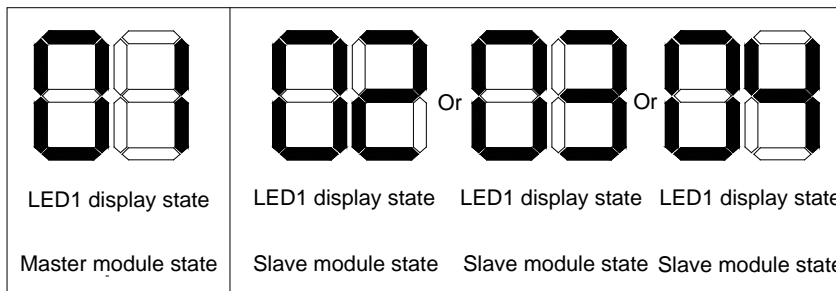

#### 3.1.1.2 Cautions on Replacement of Master ODU AP1

Before replacing master module AP1, make the following preparations:

(1) Master module DIP setting

Set the new AP1 identical to the faulty AP1. Note that settings must be performed when the master ODU is powered off and they will take effect after the ODU is powered on. Settings that are performed in power-on state are invalid.

(2) Communication state check

After AP1 DIP setting and all wiring, power on the master ODU AP1 and check whether D3 and D4 LEDs are flashing. See the figure below:

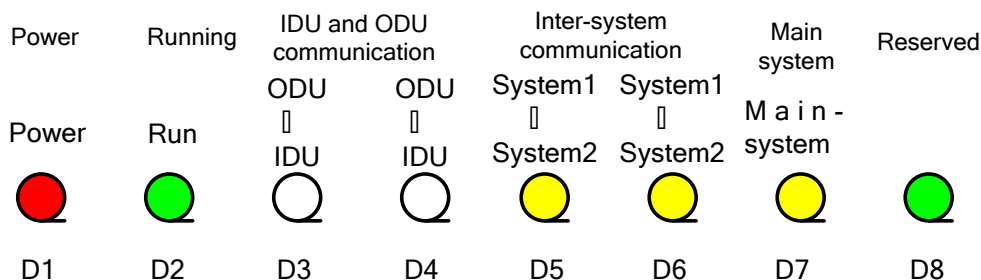

If the LEDs flash, the ODU and IDUs normally communicate; if the LEDs are steadily on, communication is faulty. Check communication lines connecting the ODU and IDUs.

**NOTE:** After AP1 is replaced, you should power on the ODU and IDUs at the same time or power on the ODU first; otherwise, “CC does not have module” will be prompted and a “C0 fault” alarm will be reported by the IDUs.

(3) Master ODU engineering debug setting

Debug the entire system after master module AP1 replacement.

(4) System parameter setting

After system debug, reset system parameters. For details, refer to section 1 “ODU Function Setting”, in part II, chapter III.

### 3.1.1.3 Cautions on Replacement of Slave ODU AP1

Before replacing slave module AP1, set DIP identical to that of the faulty AP1, check wiring, and then power on the AP1.

## ▲ CAUTION

- After replacing the main board of master module, the complete unit must start commissioning again.
- If the main board of slave module is replaced, there is no need to start commissioning for the complete unit.

## 3.1.2 Cautions on IDU AP1 Replacement

Before replacing IDU AP1, determine the module is a master IDU or a slave IDU.

### 3.1.2.1 AP1 DIP Setting and Jumper Cap Confirmation

Whatever the AP1 you replace is a master IDU AP1 or a slave IDU AP1, after it is replaced, check original DIP setting and model.

Configure capacity DIP for the new AP1 and confirm its jumper cap, fan overload detect terminal, and overflow detect terminal. They should be kept identical to those of the faulty AP1.

Their positions and corresponding silkscreen are as follows:

Capacity DIP: S1 (Capacity)

Jumper cap: U22 (Jump)

Overflow detect terminal: CN35 (WATER-DTCT)

Fan overload detect terminal: CN36 (OVC-FAN)

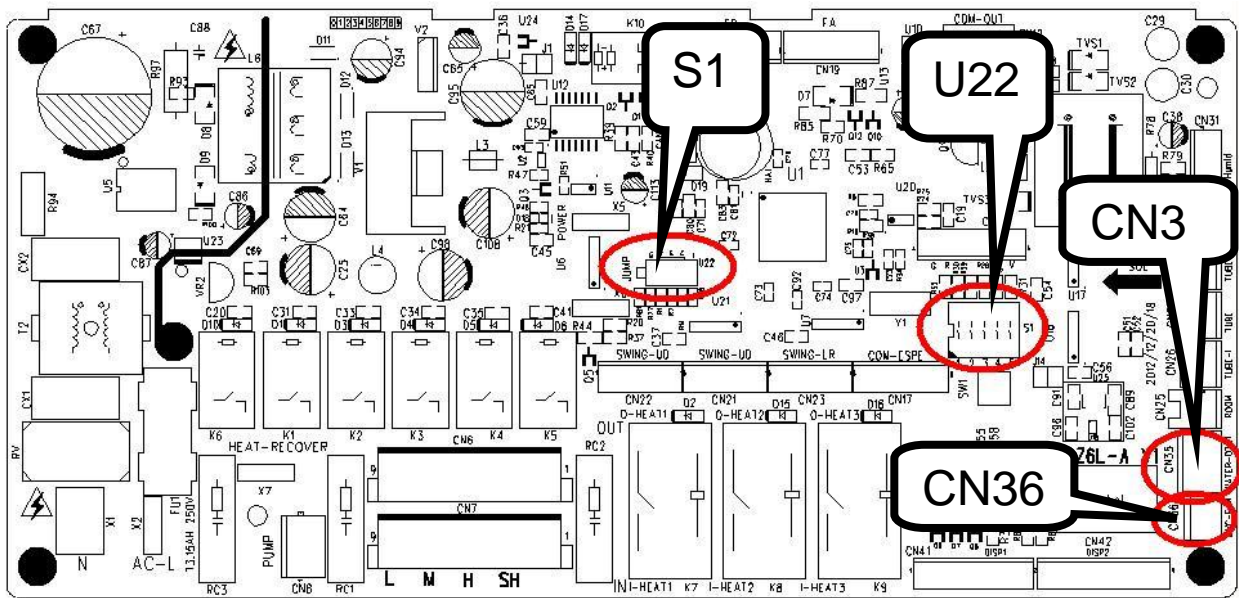

3.1.2.2. Restoring AP1 Engineering Parameters to Factory Settings (This Step Is Not Required for Original Packaged Parts)

After wiring, whatever the AP1 is a master IDU AP1 or a slave IDU AP1, the new AP1 must be restored to factory settings. There are three methods to restore engineering parameter settings:

- (1) If the IDU is configured with wired control, set P35 and P36 to default values.
- (2) If the IDU is configured with wireless control, use the special control YV1L1 to set P35 and P36 to default values.
- (3) If the IDU is configured with wireless control and special control, you can restore engineering settings through the AP1 SW1 button. After AP1 is powered on, press and hold SW1 for 5 seconds. If a tick sound is heard, release the button.

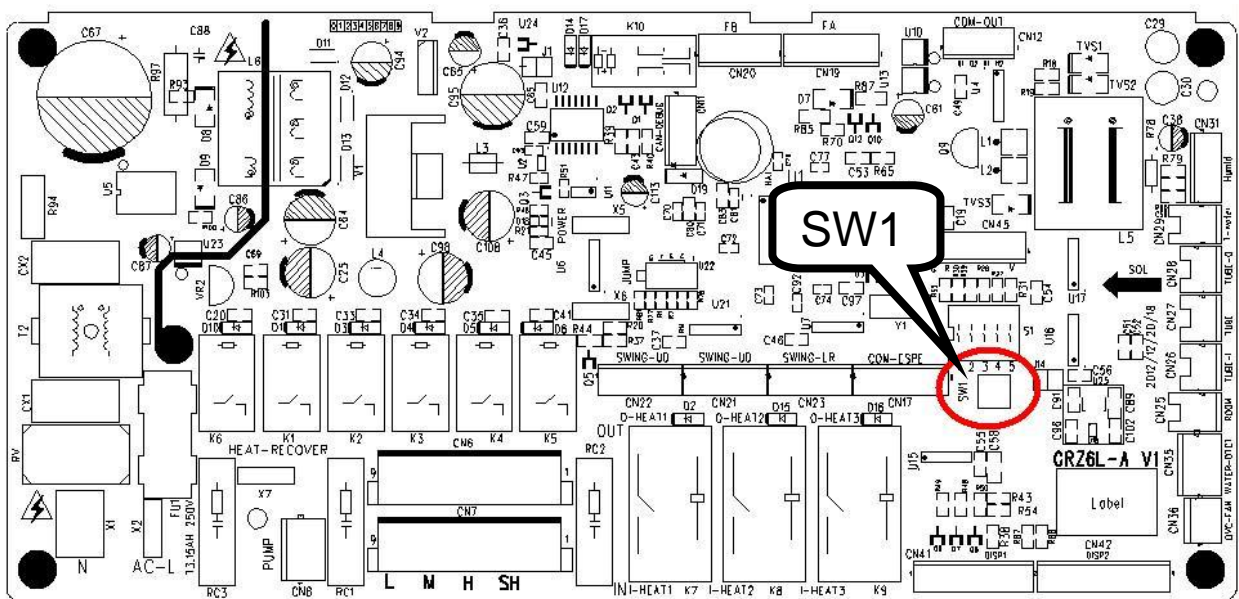

3.1.2.3 Cautions on Replacement of Master IDU AP1

If the AP1 of the master IDU needs to be replaced, after the IDU is powered on, “No master IDU (L7)” or “Project number conflict (C5)” alarm may be reported.

## (1) Troubleshoot for “no master IDU (L7)” fault



Method 1: If the IDU is configured with wired control, stop the IDU (except for lock mode) and press and hold the “MODE” button for 5 seconds to enter setting mode. After setting, the “Master” icon will be highlighted and the wired control buzzer will beep once.

Method 2: If the IDU is configured with lamp board or wired control, set to fan mode, 30°C/86°F, and press and hold “-” and “+” consecutively three times within 5 seconds. The IDU and wired control will identify it as a master IDU setting command, and show “set master IDU success (UC)” (5 seconds) and highlight the “Master” icon respectively.

Method 3: If the IDU is configured with the Debugger, set the IDU to master IDU through this software.

## (2) Troubleshoot for “project number conflict (C5)”



If this fault occurs, the number of the new AP1 is identical to that of a unit within the network. Manually change it to the original number of the faulty AP1 or a unique number. There are three methods to change project number:

Method 1: If the IDU is configured with wired control, set P42 to a new project number.

Method 2: If the IDU is configured with lamp board, use the special control YV1L1 to set P42 to a new project number.

Method 3: If the IDU is configured with the Debugger, configure a new project number through this software.

**TIP:**

If there are N units within the network, the units should be numbered from N+1.

## Special situation:

In some cases, the created project number is identical to that of a unit within the network. In this case, you can use the “one-key IDU project number reset” function. However, this function will cause the project number of the entire system to be re-distributed; thus, original number will be changed. If you do not expect this result, forbid the use of this function and replace the AP1 again.

Methods to use the “one-key IDU project number reset” function:

Method 1: If the IDU is configured with wired control, set P45 to reset IDU project number through one key function.

Method 2: If the IDU is configured with lamp board, use the special control YV1L1 to set P45 and reset IDU project number through one key function.

Method 3: On the AP1 of the master ODU, press and hold SW5 for 10 seconds at least to clear all project numbers of the IDUs and then redistribute project numbers. Other parameters are kept unchanged.

## ▲ CAUTION

- After replacing the main board of master indoor unit, the master indoor unit must be reset.

### 3.1.2.4 Cautions on Replacement of Slave IDU AP1

If the AP1 of a slave IDU needs to be replaced, after it is powered on, “Project number conflict (C5)” alarm may be reported. Refer to section 2.3 “Cautions on Replacement of Master IDU AP1” to address the issue.

## 3.1.3 Cautions on Wired Control Replacement

### 3.1.3.1 Cautions on Wired Control XK46 Replacement

(1) If the wired control to be replaced controls only one IDU, directly replace the control.

(2) If the wired control to be replaced controls multiple IDUs, perform the steps below first:

Set the wired control parameter “P14” to change the number of managed IDUs to the actual quantity the control manages. For example, if the wired control manages 3 IDUs, set this parameter to 3. If you keep the default value 1, the LCD displays L9 (as shown in the figure below).



(3) If there are two wired controls controlling one or multiple IDUs, perform the steps below first:

Set the wired control parameter “P13” to change the address of one control to 01 (master) and that of the other control to 02 (slave); otherwise, a CP (multiple master wired controls) fault alarm will be reported (as shown in the figure below).



After setting, the LCD displays the  icon, as shown in the figure below.



**NOTE:** All wired controls are set to master wired controls by default.

(4) If the AP1 of the master IDU is replaced.

Reset the master IDU through the wired control; otherwise, the LCD displays L7 (no master IDU).

There are two methods to set the IDU:

- 1) In shut mode, press and hold the “MODE” button for 5 seconds and set the IDU corresponding to this wired control to a master IDU. After setting, the “Main” icon is highlighted.
- 2) Set the wired control parameter “P10” to 1.

### 3.1.3.2. Cautions on Wired Control XK49 Replacement

To replace the wired control XK49, in addition to the preceding handling steps specific for XK46, you should also configure access control.

- (1) If the wired control does not need an access control system, set switch “1” for DIP S1 at the bottom of the wired control to digital end (neglect switch “2”).
- (2) If the wired control needs an access control system, set switch “1” for DIP S1 at the bottom of the wired control to ON (neglect switch “2”) and connect the access control card interface to ports N and L or ports VCC and GND of the wiring terminal. The following should be noted:
  - 1) Ports N and L are power interfaces of 100-240V~50/60Hz access control.
  - 2) Ports VCC and GND are power interfaces of DC 5-24V access control.
  - 3) Either of them can be selected at one time.

## 3.2 COMPRESSOR REPLACEMENT AND CAUTIONS

### 3.2.1 Determining Compressor Fault

3.2.1.1 Precondition: Units can be normally started.

#### Step 1:

If units can be normally started, start the units so as to measure line current of the faulty compressor. Use a pressure gauge to measure pressure of various valves and connect the gauge to a PC for viewing test data. Verify the current data in the figures below against the current recommended. For inverter compressors, current will be deviated 10% while rate of turn and operating condition vary.

(1) For inverter compressors E706DHD-72A2YG:

The figure below shows current curves that change with evaporating temperature and condensing temperature while the compressors work at 30 Hz.



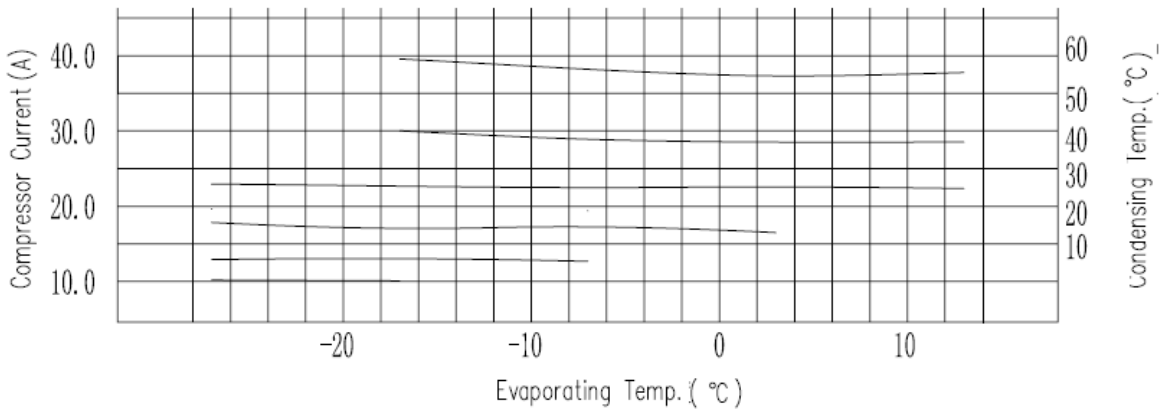

The figure below shows current curves that change with evaporating temperature and condensing temperature while the compressors work at 60 Hz.

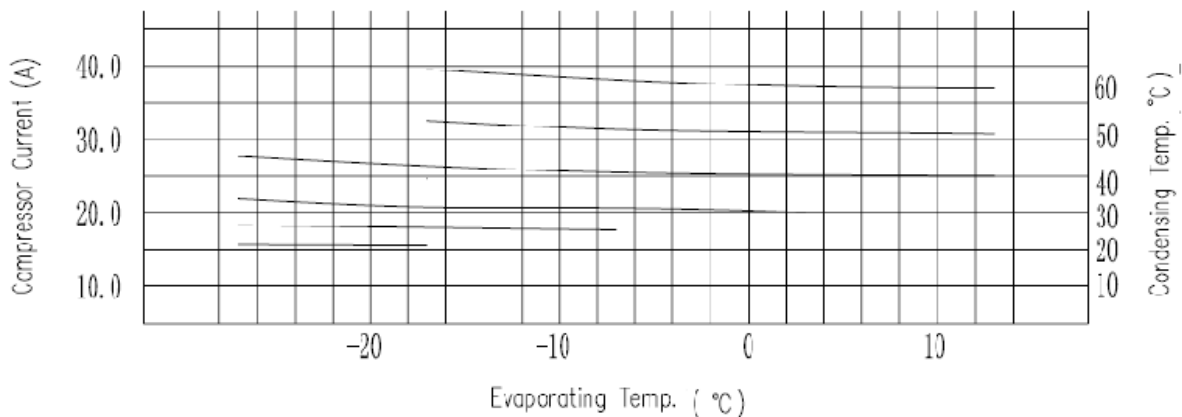

The figure below shows current curves that change with evaporating temperature and condensing temperature while the compressors work at 90 Hz.

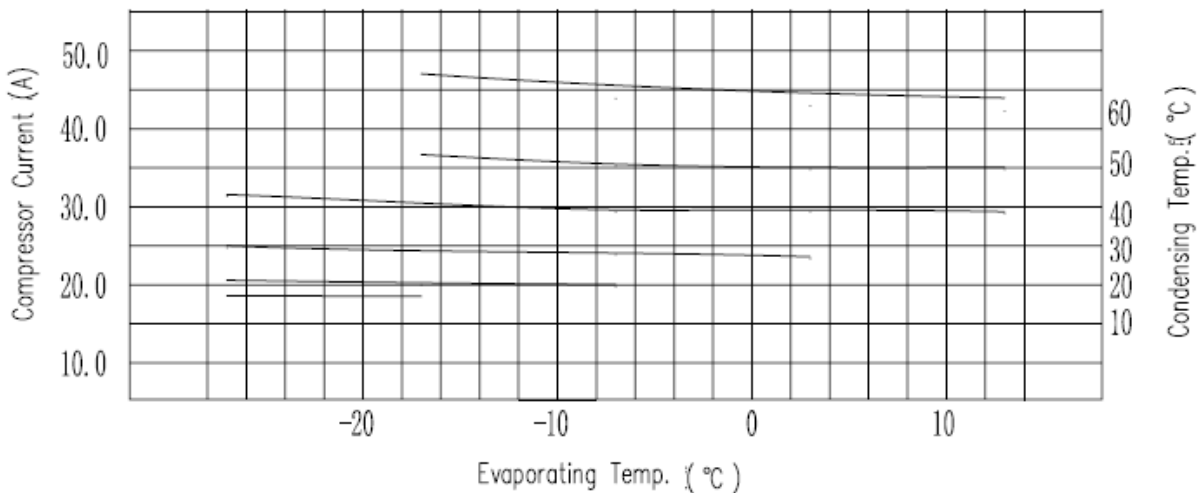

**NOTE:** You can infer from the preceding figures the current of the compressors operating at other frequency bands.

(2) For inverter compressor E405DHD-38A2YG:

The figure below shows current curves that change with evaporating temperature and condensing temperature while the compressor works at 30 Hz.

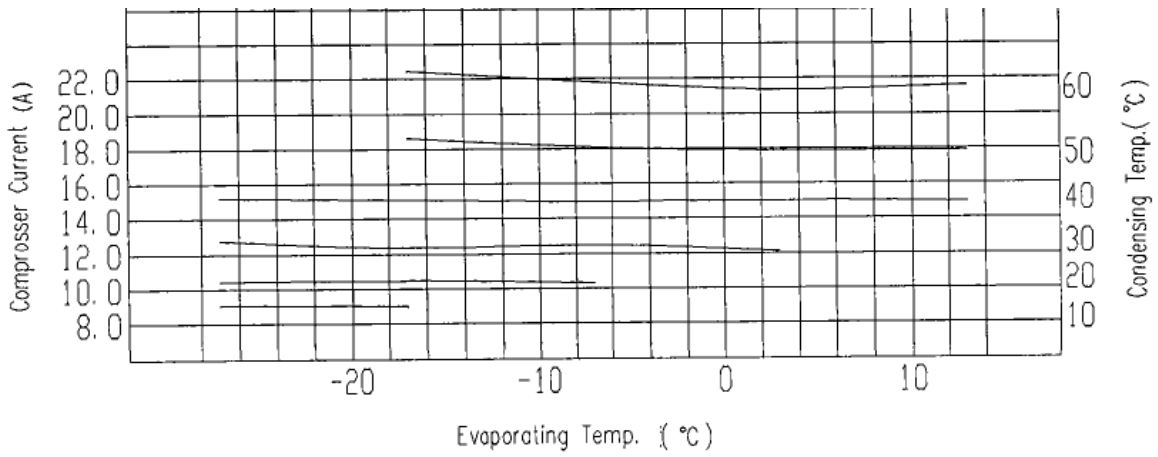

The figure below shows current curves that change with evaporating temperature and condensing temperature while the compressor works at 60 Hz.

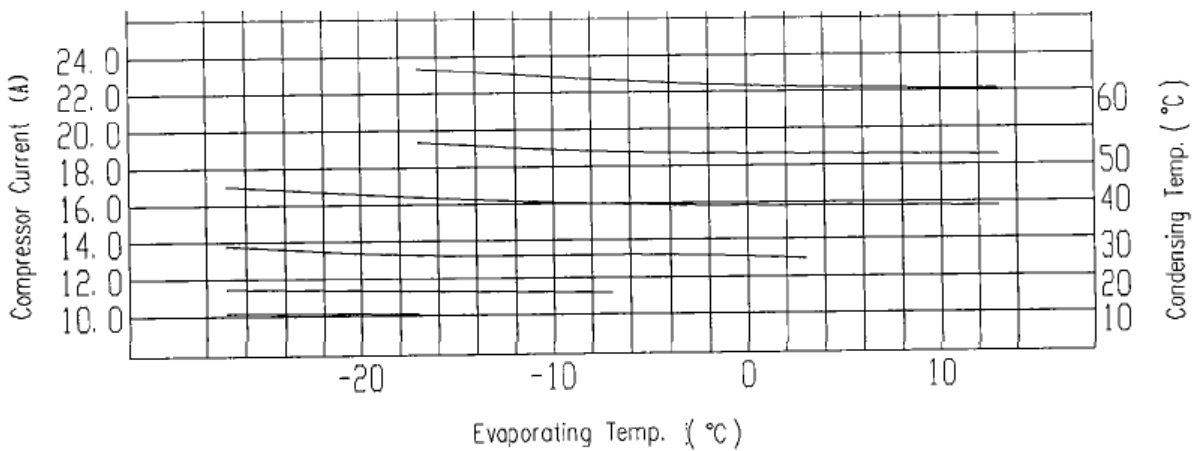

The figure below shows current curves that change with evaporating temperature and condensing temperature while the compressor works at 90 Hz.

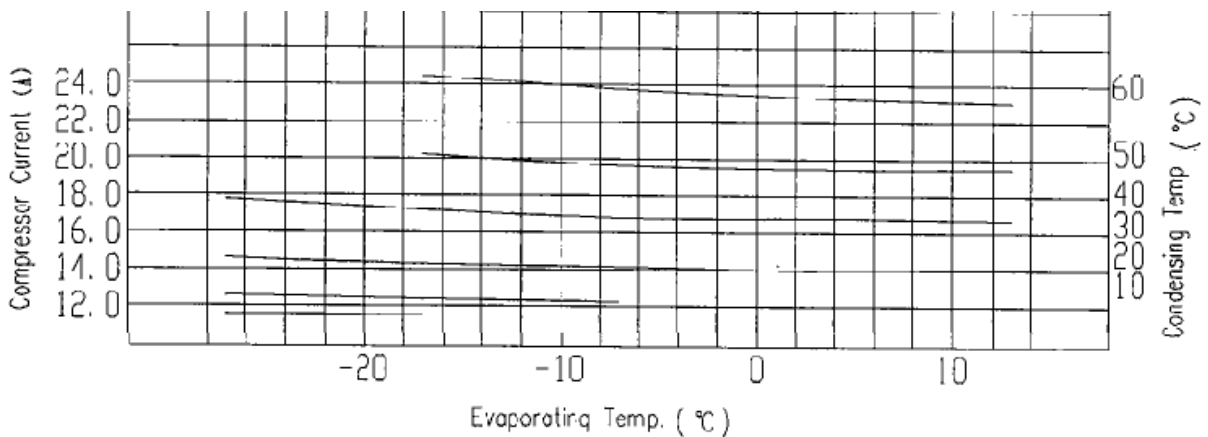

**NOTE:** You can infer from the preceding figures the current of the compressor operating at other frequency bands.

**Step 2:**

Check whether the compressor sounds sharp or rubs. Compare the sound of the faulty compressor with that of normal ones.

**Step 3:**

Check whether the electric expansion valves of ODUs and the 4-way valves act, and whether the oil return pipes and oil balance valves 1 and 2 are normal. Touch the pipelines next to the return capillary

tubes to check whether there is oil flowing.

Check method for each part:

- 1) Electric expansion valve: This valve will reset for each power-on or power-off action. Touch the valve and you will feel its vibration during the reset action. A crack sound will be heard as well.

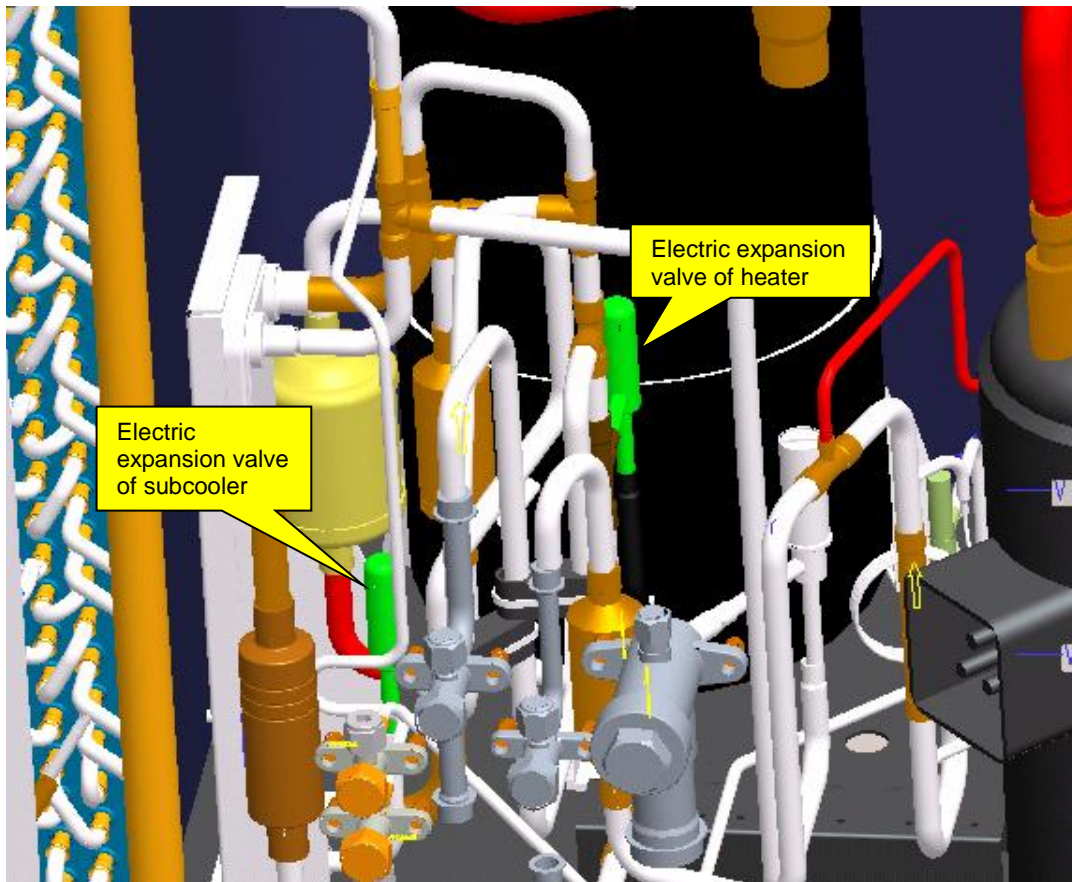

Description of electric expansion valve:

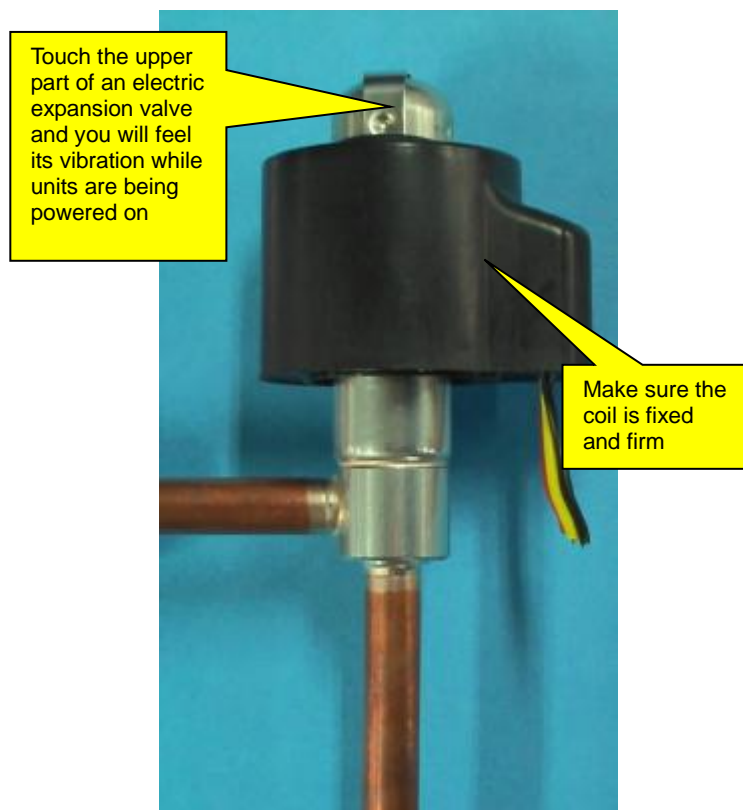

- 2) Four-way valve: While this valve is normally running, the four copper pipes connected to it will suffer different temperature. When a unit switches to act the valve, you will feel obvious vibration and hear sound.

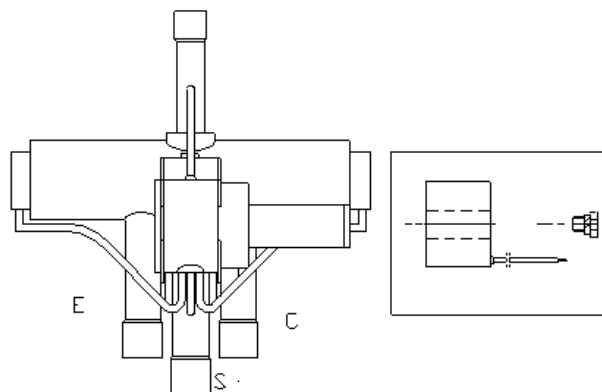
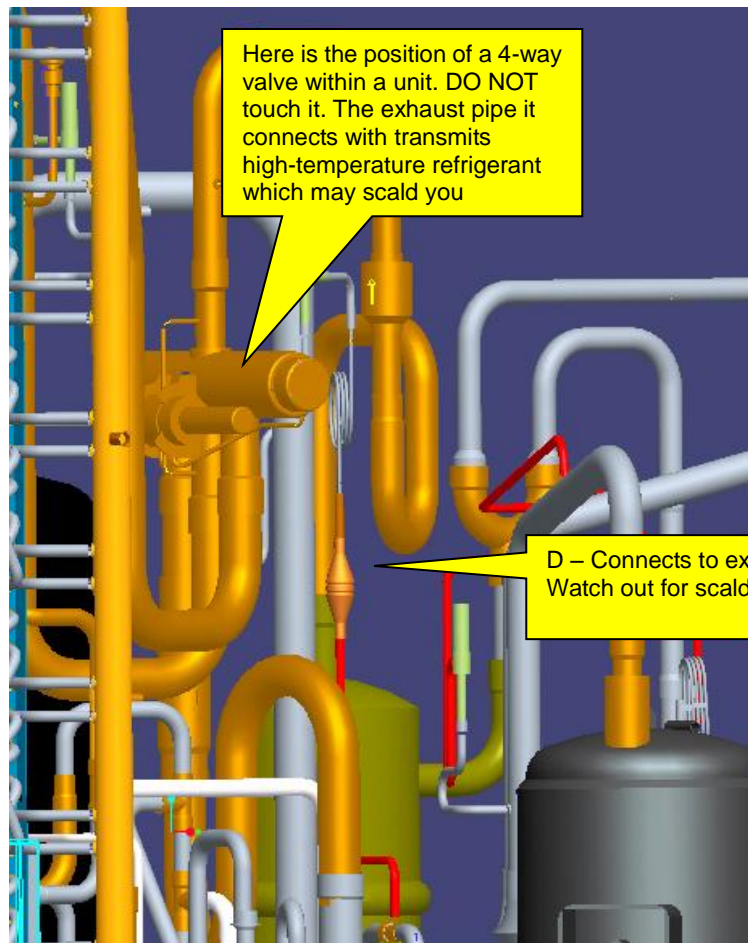

Labels on the 4-way valve and their meanings: D – connects to exhaust; E – connects to IDU evaporator; S – connects to intake of gas separator; C – connects to condenser. When the system is cooling, the pipe at side C works at high pressure high temperature, the pipes at sides E and S work at low pressure low temperature; when the system is heating, the pipe at side E works at high pressure high temperature, the pipes at sides C and S work at low pressure low temperature. The pipe at side D connects to exhaust and it is always working at high pressure high temperature. When units are starting, defrosting, or returning oil, the valve will vibrate obviously. DO NOT touch the pipe; or, you may be scalded.

- 3) Oil balance solenoid valve: This valve can be operated based on its state that is shown through the monitoring software and actual situation. When this valve is opened, the coil will be heated and lubricant at both sides of the valve flows.

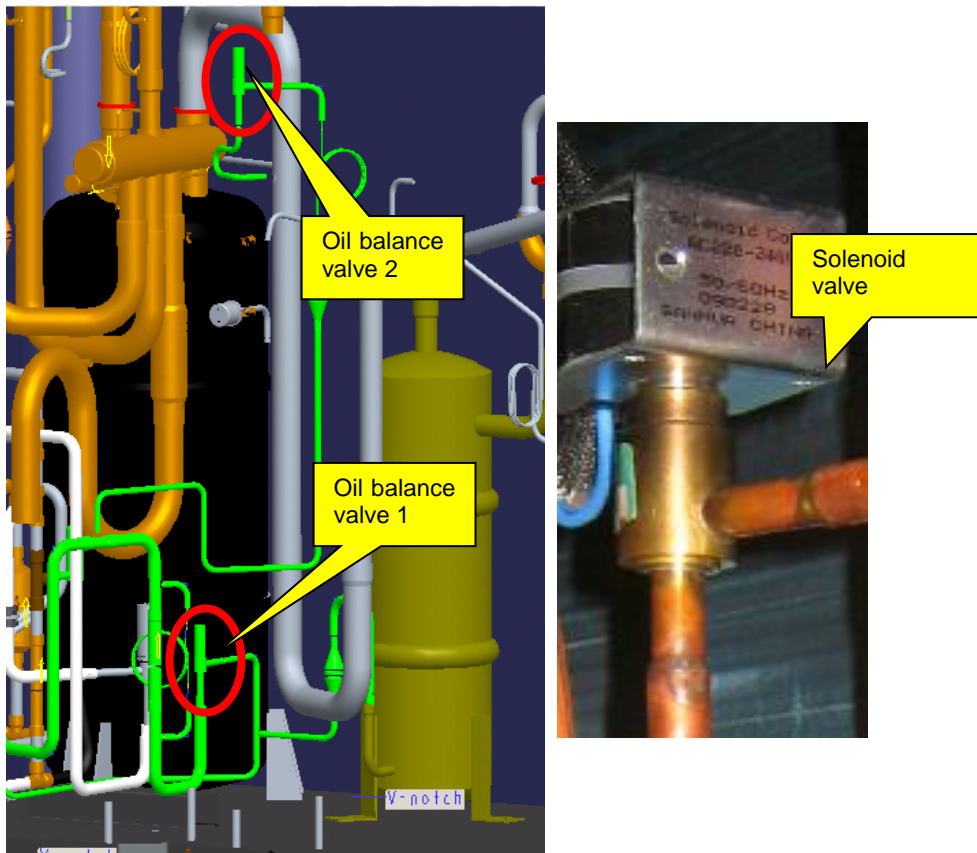

**Step 4:**

Test the compressor drive, namely the IPM module, to see whether it is normal.

- 1) Disconnect the power supply. Five minutes later, remove the line of the faulty compressor.
- 2) Set a multimeter to gear diode. As shown in the figure below, put the black test probe to pad P (on the left of pad U (BL)) and the red test probe to pad U (BL) (make sure the moisture proof tape is removed). In normal cases, the multimeter should read  $0.39 \pm 0.3$  V. If it is "0" or infinitely great, the IPM module is faulty.

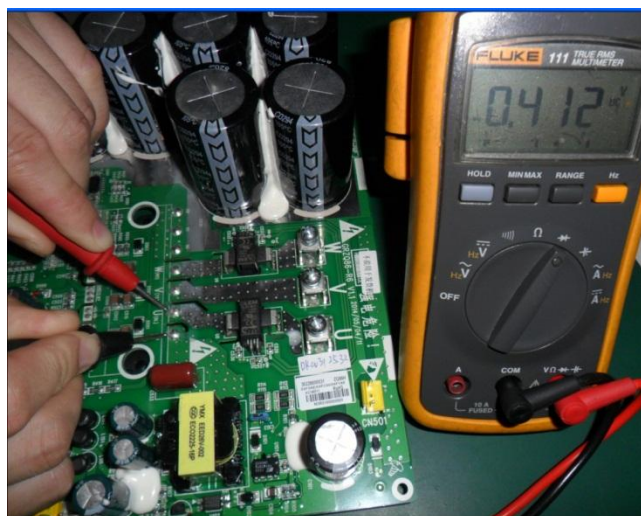

- 3) As shown in the figure below, put the black test probe to pad P and the red test probe to pad V

(YE) (make sure the moisture proof tape is removed). In normal cases, the multimeter should read  $0.39\pm 0.3$  V. If it is "0" or infinitely great, the IPM module is faulty.

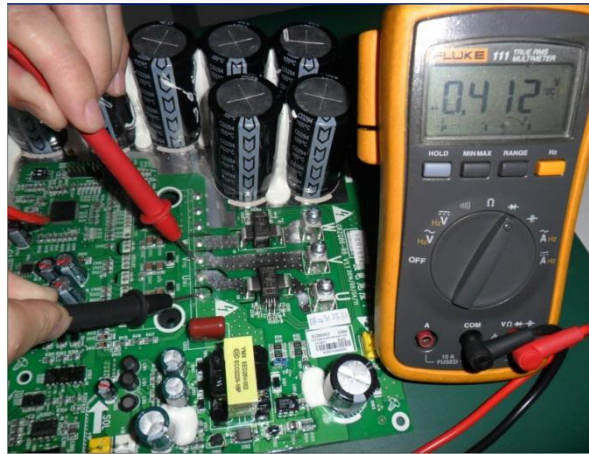

- 4) As shown in the figure below, put the black test probe to pad P and the red test probe to pad W (RD) (make sure the moisture proof tape is removed). In normal cases, the multimeter should read  $0.39\pm 0.3$  V. If it is "0" or infinitely great, the IPM module is faulty.



- 5) As shown in the figure below, put the black test probe to pad U (BL) and the red test probe to pad NU (make sure the moisture proof tape is removed). In normal cases, the multimeter should read  $0.39\pm 0.3$  V. If it is "0" or infinitely great, the IPM module is faulty.

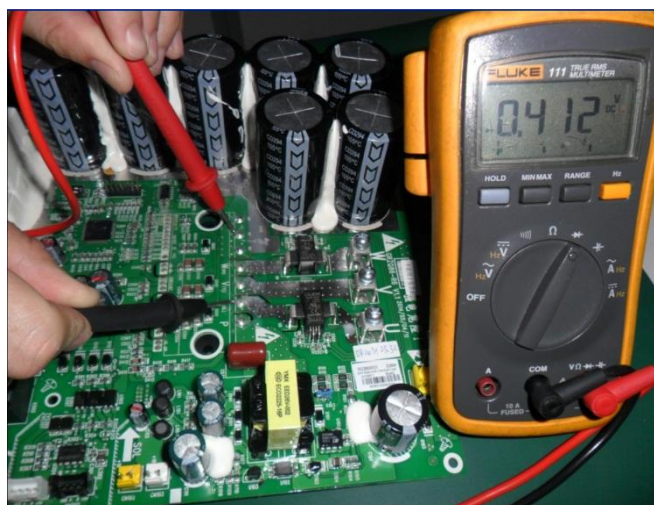

- 6) As shown in the figure below, put the black test probe to pad V (YE) and the red test probe to pad NV (make sure the moisture proof tape is removed). In normal cases, the multimeter should read

0.39±0.3 V. If it is “0” or infinitely great, the IPM module is faulty.

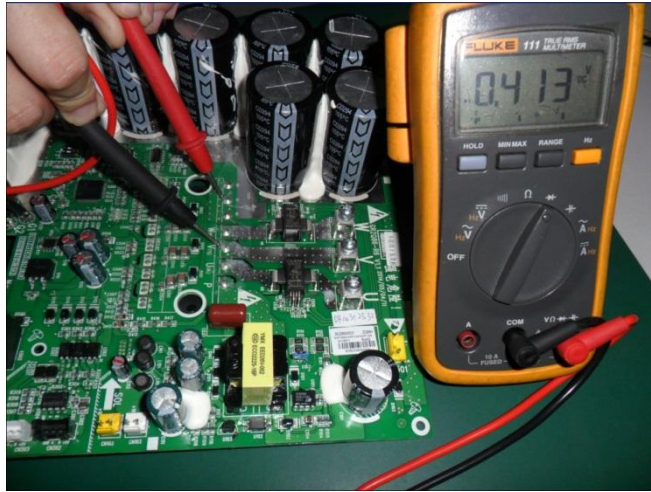

7) As shown in the figure below, put the black test probe to pad W (RD) and the red test probe to pad NW (make sure the moisture proof tape is removed). In normal cases, the multimeter should read 0.39±0.3 V. If it is “0” or infinitely great, the IPM module is faulty.



### 3.2.1.2 Precondition: Units cannot be normally started

**Step 1:**

Disconnect the power supply of the units and open the electric junction box of the compressor to see whether wiring of the compressor is intact.

**Step 2:**

Measure resistance between two wiring terminals (U, V, W). The resistance value range should be 0.5~2.0  $\Omega$ .

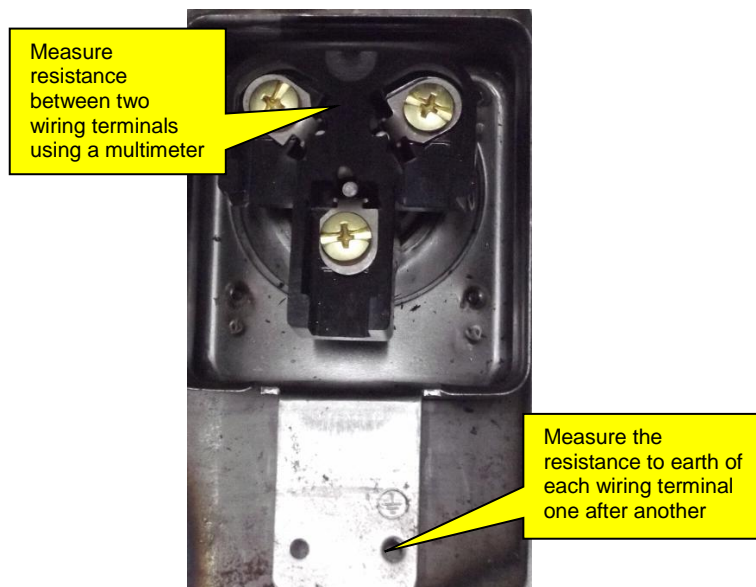

Measure the resistance to earth of each wiring terminal. The value should be 10 M $\Omega$ . If not, the compressor has an internal fault.

**Step 3:**

Check the solenoid valves of the system, include electric expansion valves, oil return valves, and oil balance valves. Refer to the preceding section for the test method.

**Step 4:**

Check the IPM module. Refer to the preceding section for the test method

## 3.2.2 Compressor Replacement (GMV-120WM/B-F (U))

**Step 1: Disconnect power supply.**

Turn off the power switch of the ODUs and disconnect the line of the power supply and the power line of the ODUs. Meanwhile, cover the power line with tape for insulation and put a warning sign beside the power switch to prevent electric shock.

**Step 2: Clear electric parts (do not need to disassemble the electric box).**

Before removing compressors' lines, temperature sensors, and electric heaters, mark them so that you will reconnect them in a correct manner after clearing. The removed electric box must be covered and protected from wind and sun.

After the box is removed, take care with the removal of electric parts' lines. DO NOT pull the lines with excessive force; or they may be broken. The removed electric box must be protected for dustproof and waterproof purposes.

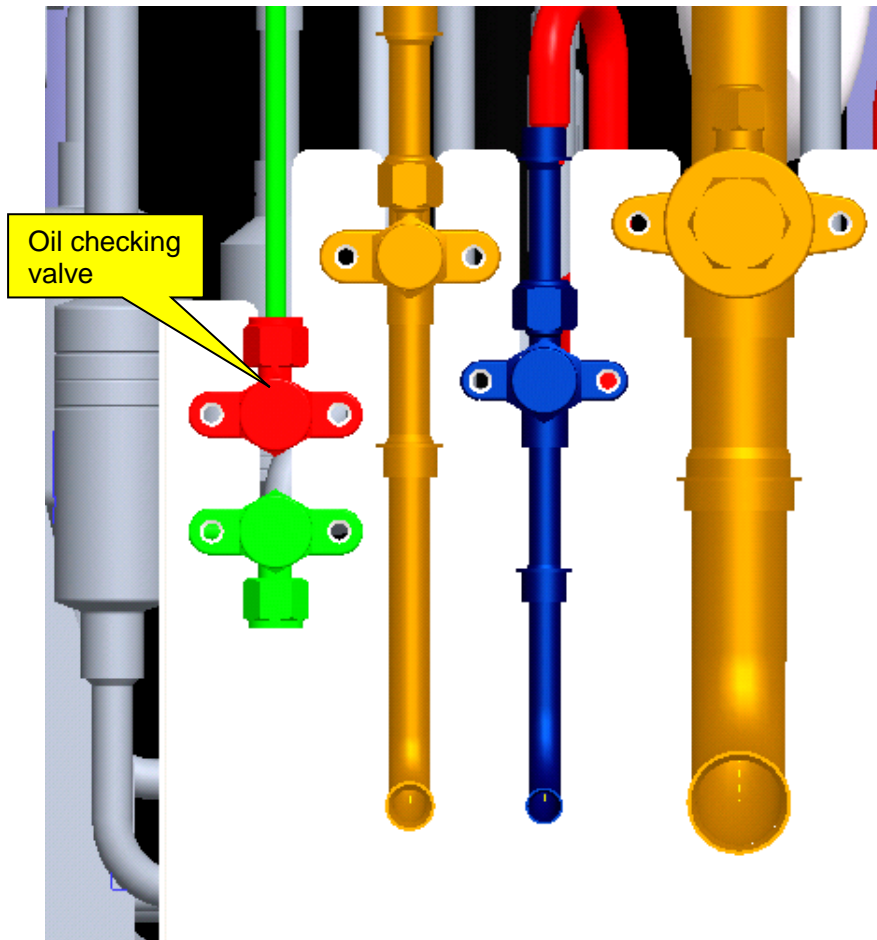

**Step3: Check oil quality.**

When system's internal pressure drops to 0.01Mpa (1.45psi), get some oil through the oil checking valve. Connect a rubber hose to the oil checking valve at one end and a glass container at the other end. Open the oil checking valve. Control oil flow speed. Since the oil is a mixture of volatile refrigerant and lubricant, DO NOT cover the container; or it may explode.

After the lubricant is fully gasified, record the volume of oil.

**Step 4: Release refrigerant.**

Refrigerant should be released from the high pressure side and low pressure side at the same time. If it is released from one side only, the scroll is sealed, causing the refrigerant to fail to be released completely. Control the release speed (it is expected to release for 12 hours or more). If too fast, massive lubricant will be discharged with the refrigerant. Make sure to mark the valves.

**NOTE:** When releasing the refrigerant, if system's internal pressure drops to 0.01Mpa (1.45psi), perform Step 4—Check oil quality.

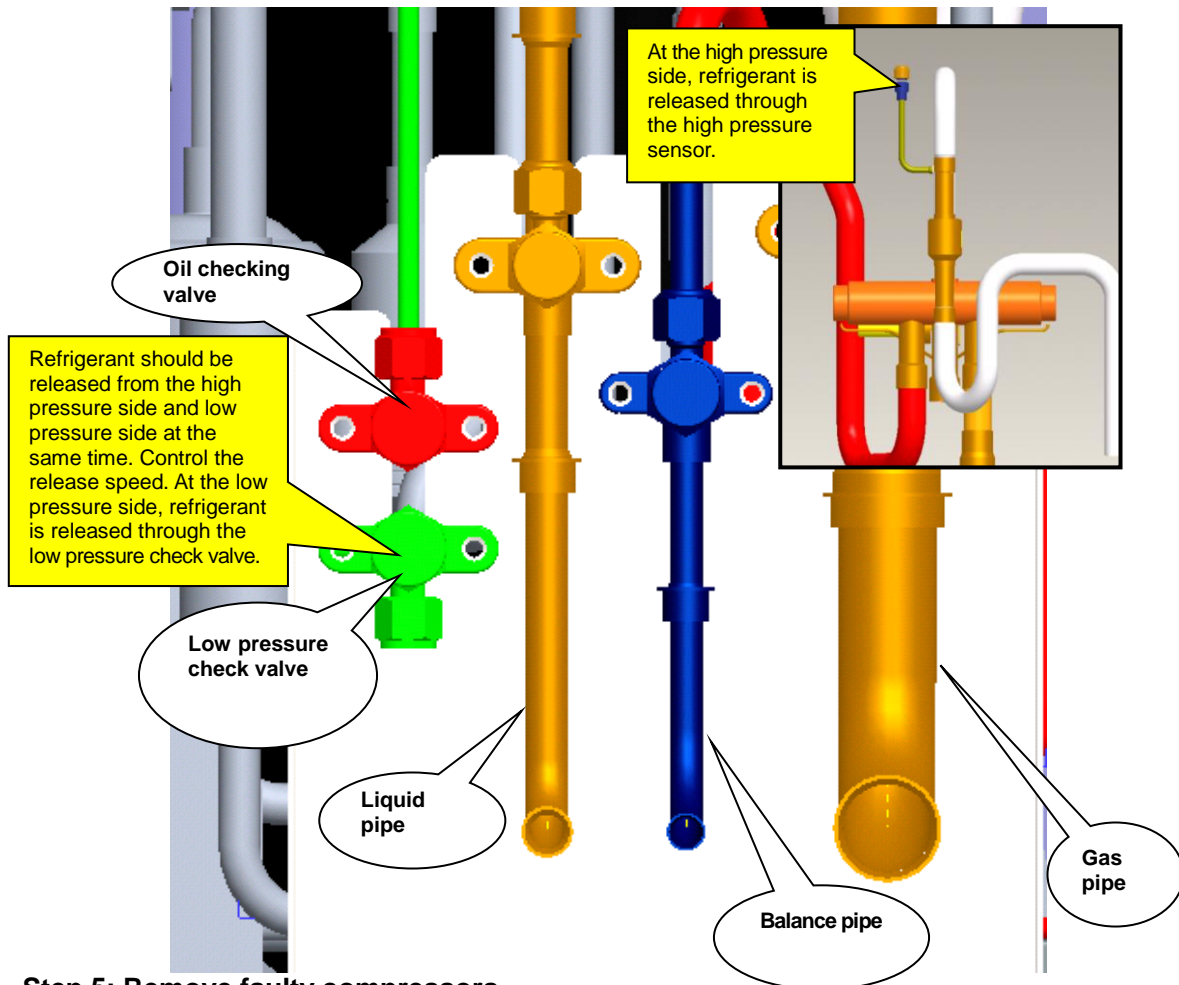

### Step 5: Remove faulty compressors.

Confirm faulty compressors, including number of faulty ones, compressor position, and model.

Handling procedure varies with compressor model.

Inverter compressors and oil quality

If the inverter compressor is damaged, or the oil of the fixed speed compressor is contaminated, remove the inverter compressor.

After the compressor and oil separator are removed, check oil quality. If oils are contaminated, replace the compressor, oil separator, and gas/liquid separator. If oil changes to black, check oils of other modular units. The check procedure is similar to the preceding.

**Note:** Before replacing the faulty compressors, make sure to block their openings with tapes. They should be kept intact for further analysis.

### Step 6: Check system parts.

If system oil is contaminated, check unit parts, including oil separator, gas/liquid separator, and storage tank.

1) Check oil separator.

Remove the oil separator. For the removal procedure, refer to step 4. Tilt the separator to draw oil out into a container. Block the container for further factory inspection.

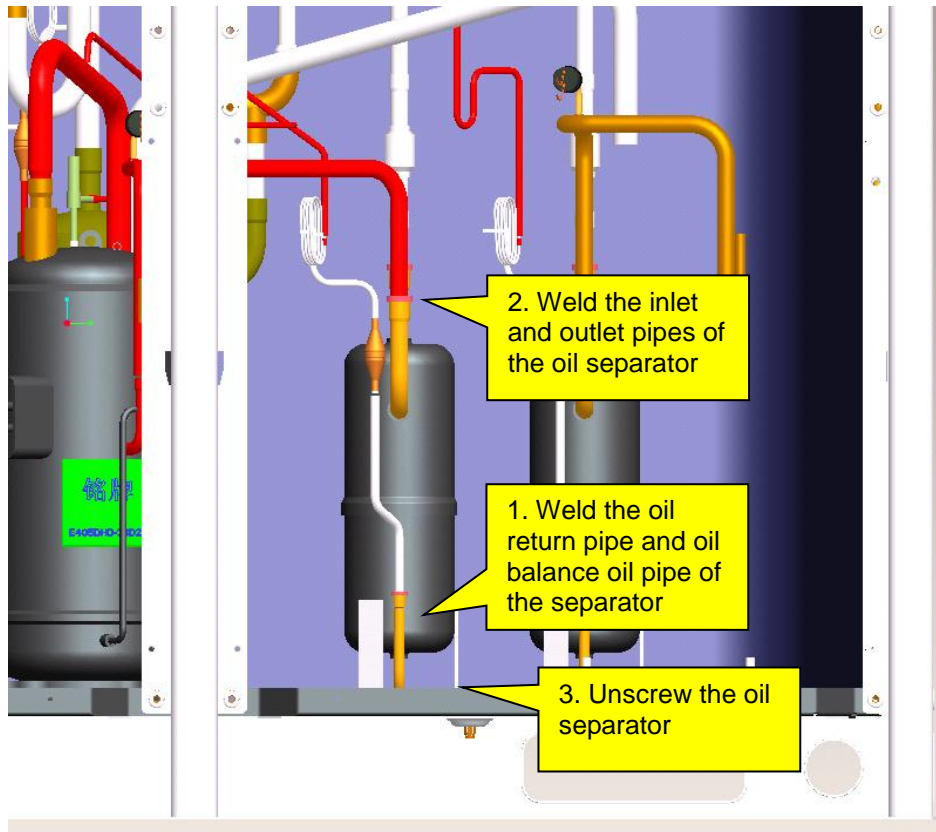

2) Check oil balancer.

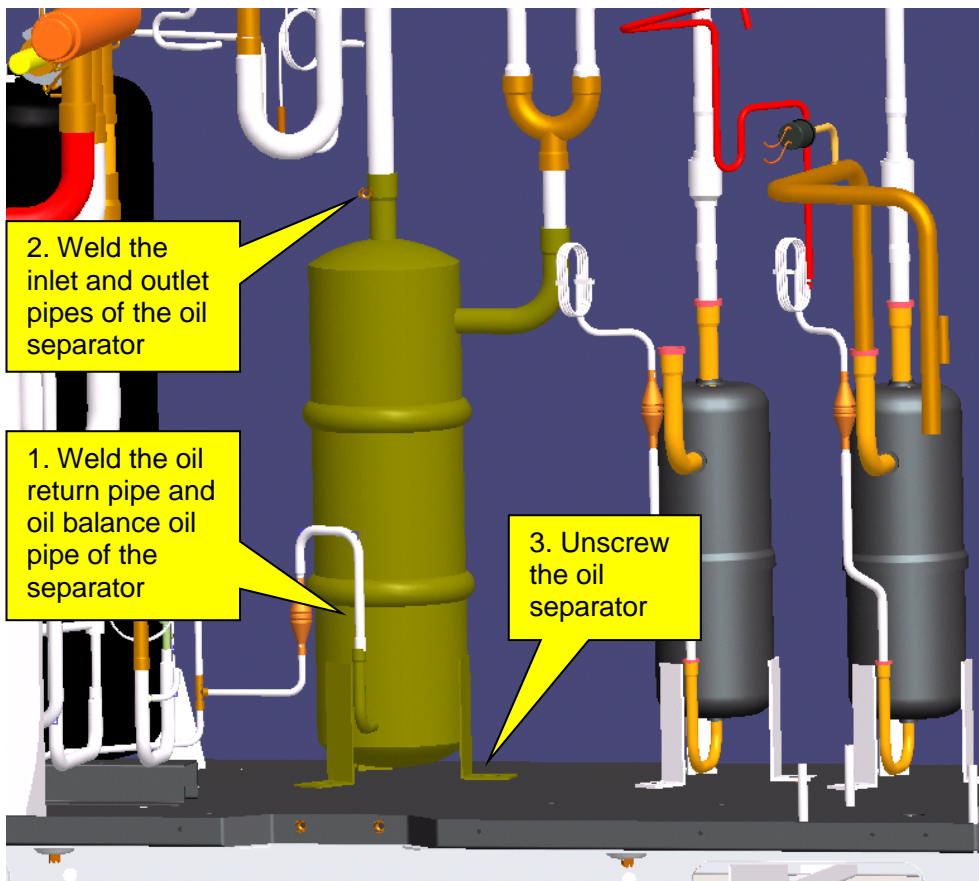

## 3) Check gas/liquid separator.

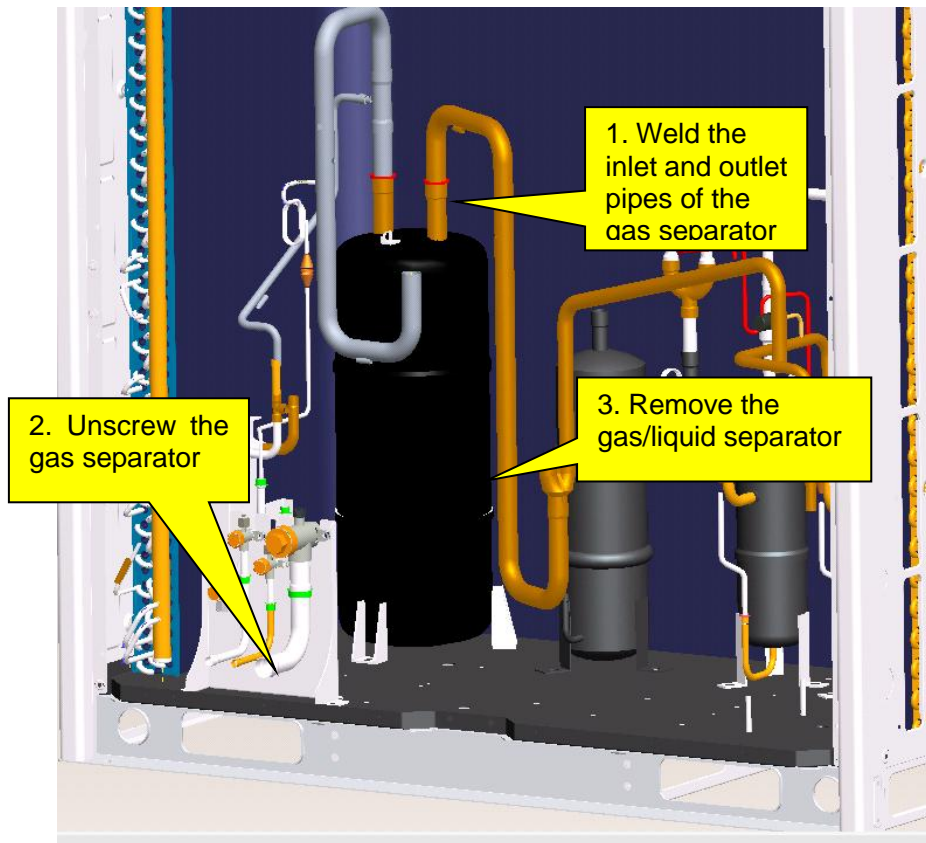

After the gas separator is taken out, check whether it contains impurities. The check procedure is as follows:

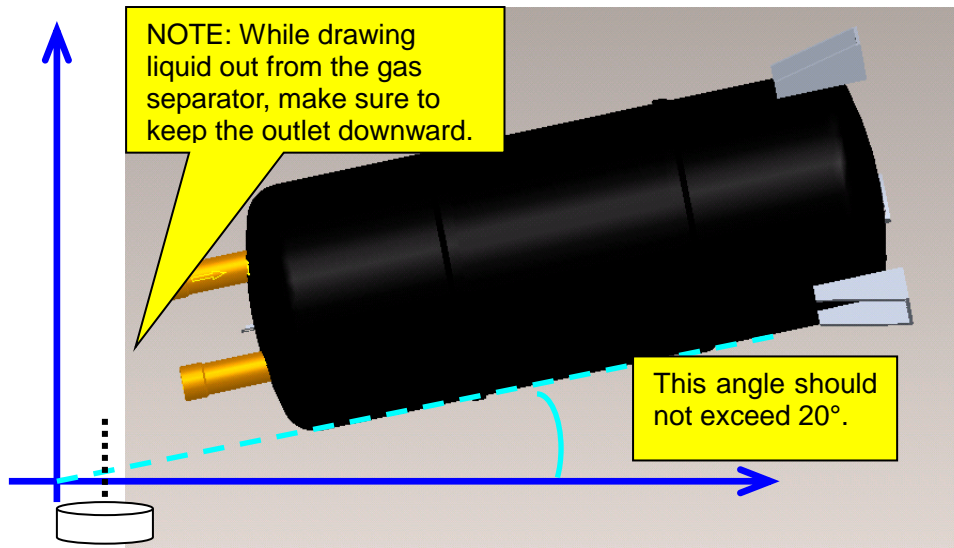

Use a glass container to hold the liquid. Check liquid impurities and colours and block the container for further factory inspection.

**NOTE:** If the compressor needs replacement, the gas/liquid separator needs replacement as well, regardless whether the separator contains impurities or has faults or not.

## 4) Check oil return pipes.

Remove oil return pipes and balance pipes, and check oil volume and impurity.

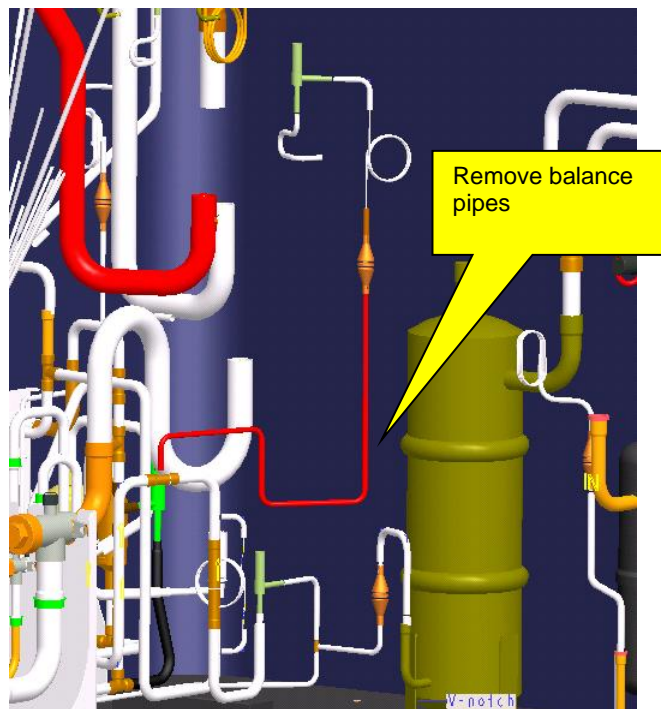
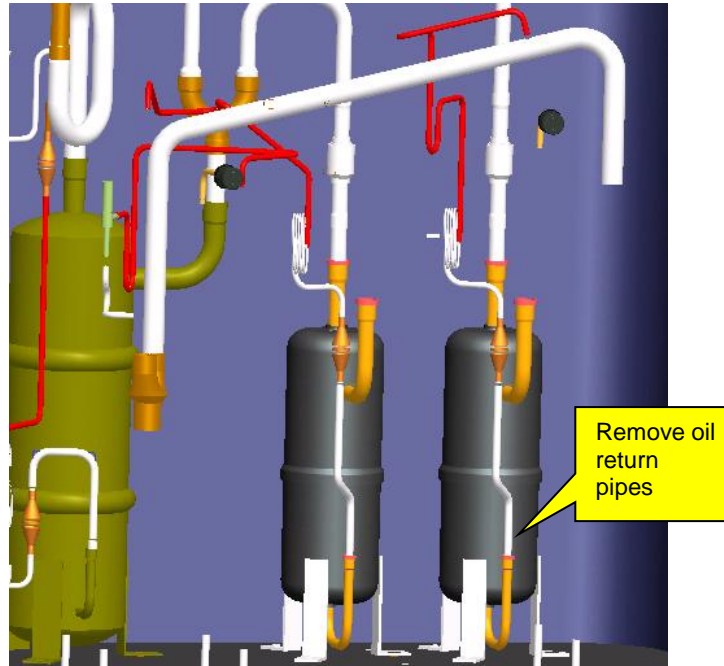

**NOTE:** Before replacing the faulty parts, make sure to block their openings with tapes. They should be kept intact for further analysis.

**NOTE:** Volumes of oils drawn out from the oil separator, gas separator, and oil balancer should be recorded. After faulty compressors and parts are replaced, you should fill new oils of equivalent amount into the compressors and parts.

**Step 6: Clear pipeline system.**

Check pipelines for abnormalities. Charge nitrogen into the main pipeline and clear the pipeline system.

1) Clear the balance pipes.

Components of oil balance valve 1:

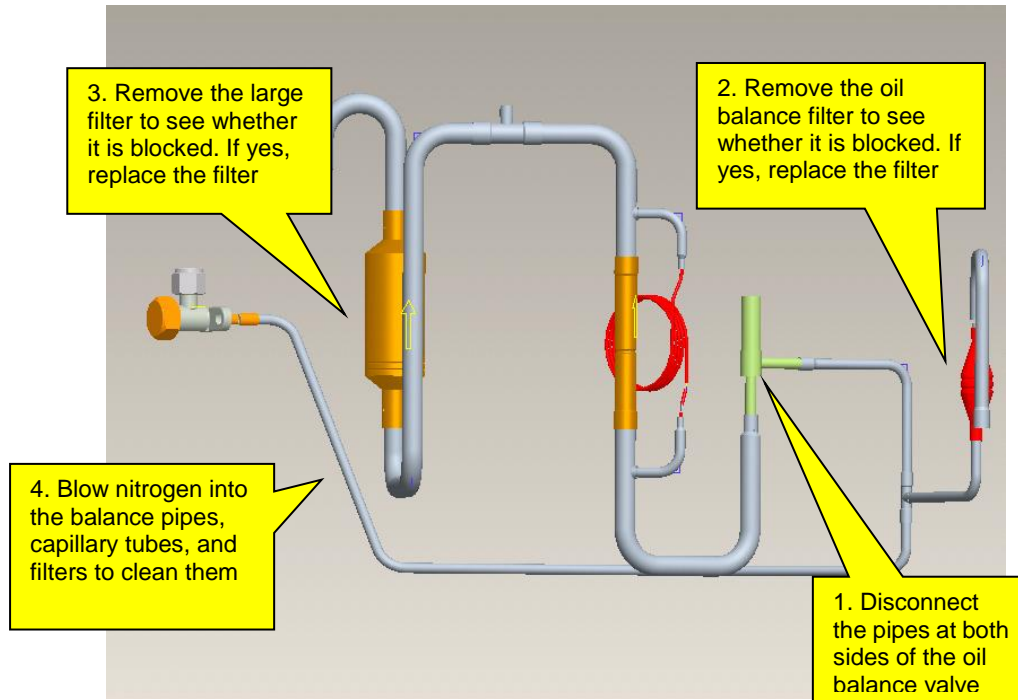

Components of oil balance valve 2:

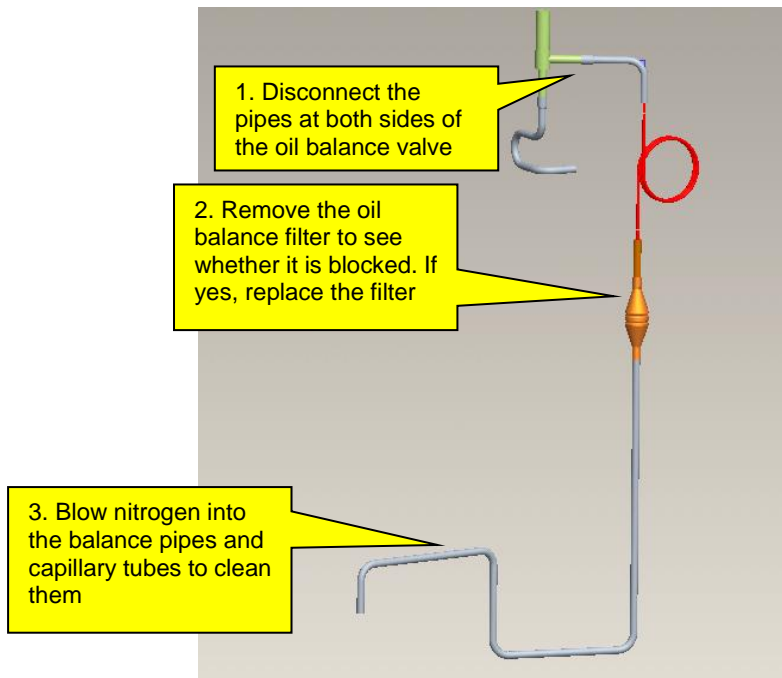

## 2) Clear oil return pipes.

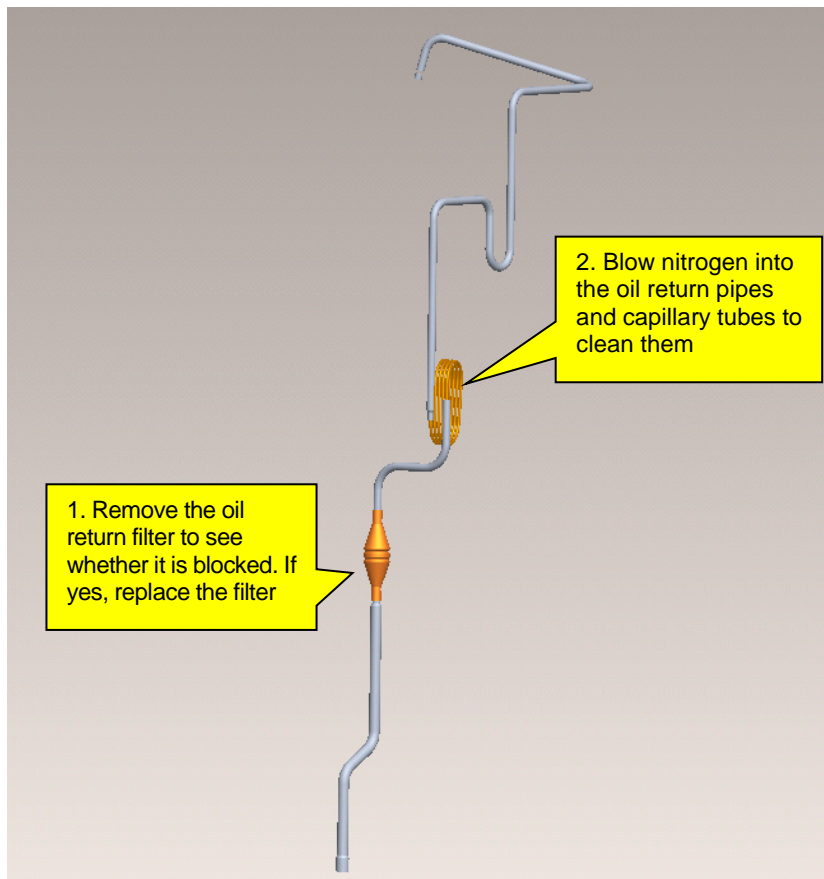

## 3) Clear liquid pipe filters.

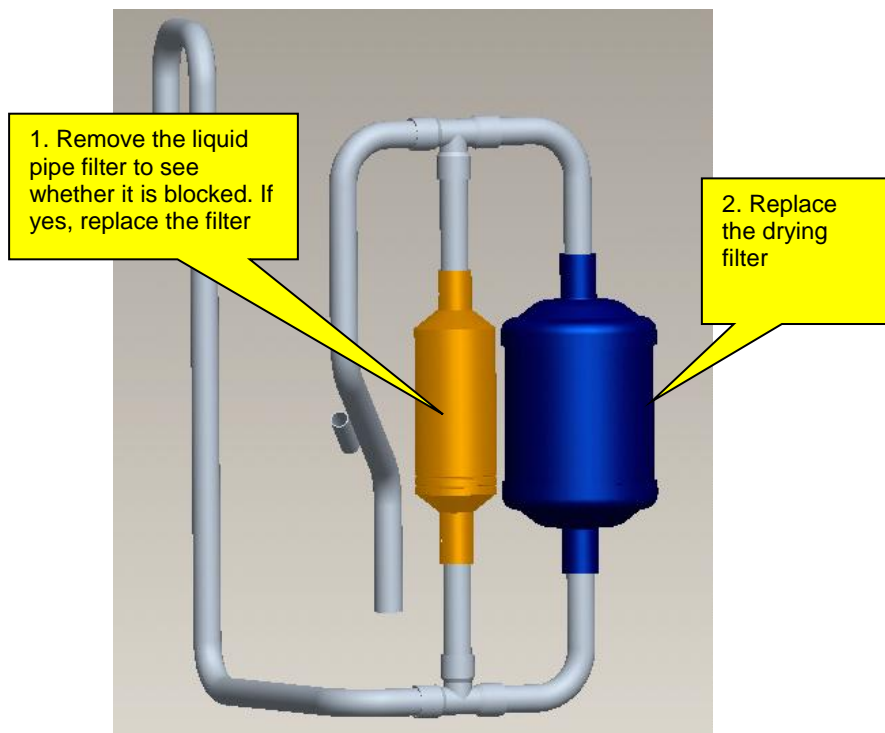

For other pipeline parts, clear them based on actual situation. If you do not replace the parts immediately, make sure to block the pipes with tapes, preventing air moistures and impurities from contaminating them.

**Step 7: Preparations.**

1) Prepare new parts.

In the course of moving compressors, do not lay them down or put them upside down. The tilt angle should be less than 30°. Make sure oil will not overflow from the oil balance opening. The inlet and outlet should be blocked. If the sealing rubber is not available, cover them with tape to prevent direct contact of oil and air.



**NOTE:** The new compressor must be consistent with the faulty one in model.

Check the rubbers for oil separator, gas separator, oil balancer, and drying filter. If they are lost during transportation, cover the parts with tape to keep the compressor dry and airtight inside.



**NOTE:** Compressor lubricant must be kept completely airtight. Hitachi compressors use special



lubricant FVC68D or FV-68H whose moisture absorption capability is high. Requirements on air-tightness of these compressors are higher.

2) Prepare other materials.

- a. Prepare nitrogen. Prepare enough nitrogen. They will be used during welding. Nitrogen pressure should be 2.0 MPa (290psi) at least.
- b. Prepare welding rods. In addition to ordinary welding rods, you should also prepare special welding rods (containing 5% or more silver). Compressors' inlets and outlets are made of copper plated steels, which require special welding rods and materials.
- c. Prepare gases for welding. Oxygen and acetylene of proper amount should be determined with consideration of actual welding positions. Try to finish the welding task once. Avoid repeated welding.
- d. Prepare tools, including hexagon, diagonal pliers, combination pliers, needle nose pliers, multimeter, pressure gauge, Phillips screwdriver, flathead screwdriver, wrenches (at least two), PVC insulation tape, and tielines (multiple).

**Step 8:** Install a new gas/liquid separator.

**NOTE:** If a faulty compressor needs replacement, the gas/liquid separator needs replacement as well. This is to avoid abnormality from happening inside the gas separator, and affecting system safety and reliability.

Put the gas/liquid separator on a chassis and connect the inlet pipe of the gas separator with the outlet pipe. Then, connect the pipe to a nitrogen source. The nitrogen source can be connected based on actual situation, for example, you can add a bypass interface or directly connect the nitrogen source to the inlet/outlet pipe. If the pipe is big, cover it with tape as well. Make sure nitrogen can smoothly flow through the gas separator.

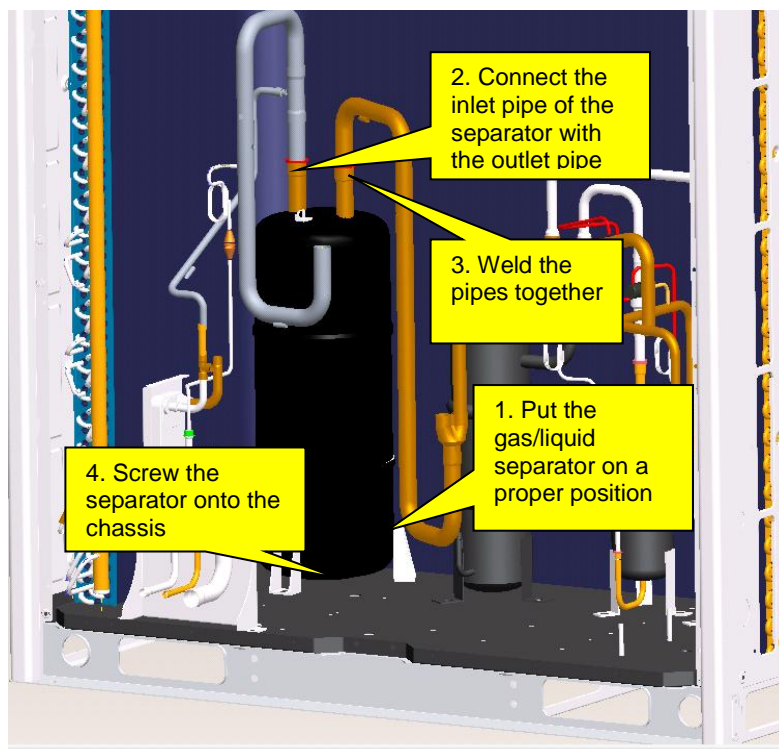

**Step 9: Install a new oil balancer.**

The original oil balancer, if it is found to have no impurities or other objects, can be used further more. This part serves as a container and it does not have complex structure. However, if it contains impurities or other objects, replace it. This is because a dirty oil balancer cannot be thoroughly cleaned.

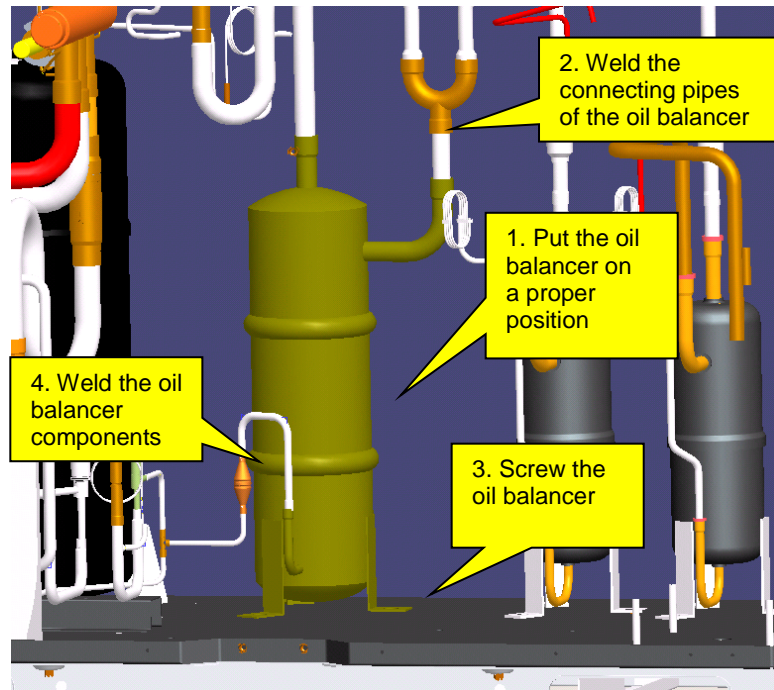
**Step 10: Install a new oil separator.**

If the original oil separator contains impurities inside, replace it.

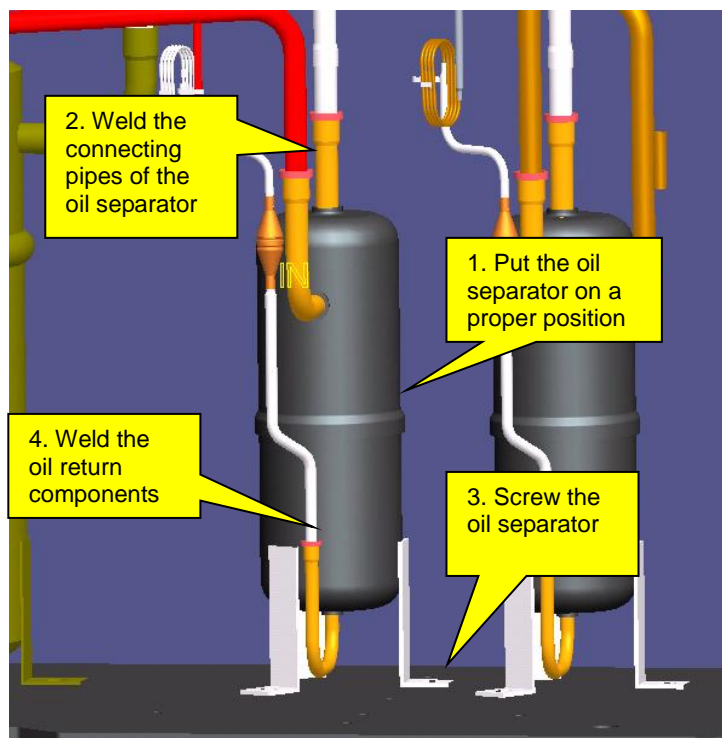

**Step 11: Install a new compressor.**

If it is a inverter compressor that needs replacement

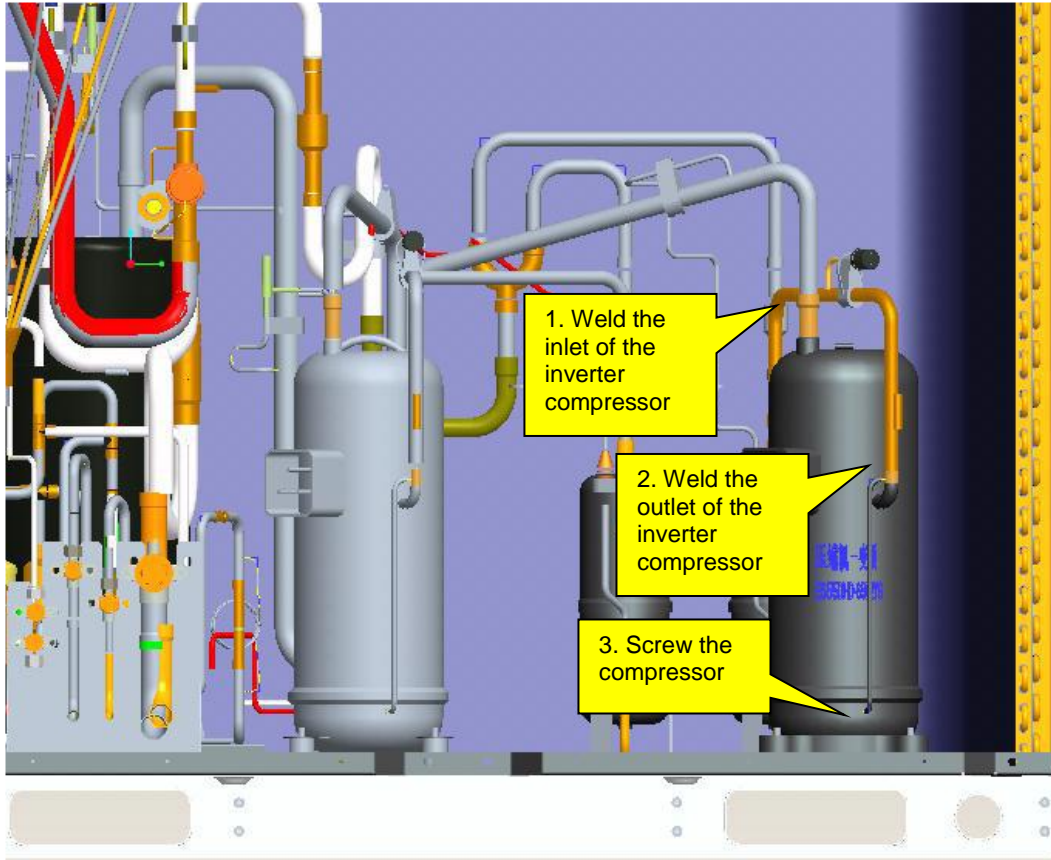

For compressors of GMV-120WM/B-F (U) unit, make sure the new compressors are consistent with the faulty ones in model. If both compressors need replacement, make sure corresponding position and wiring are correct. You are advised to replace them one after another.

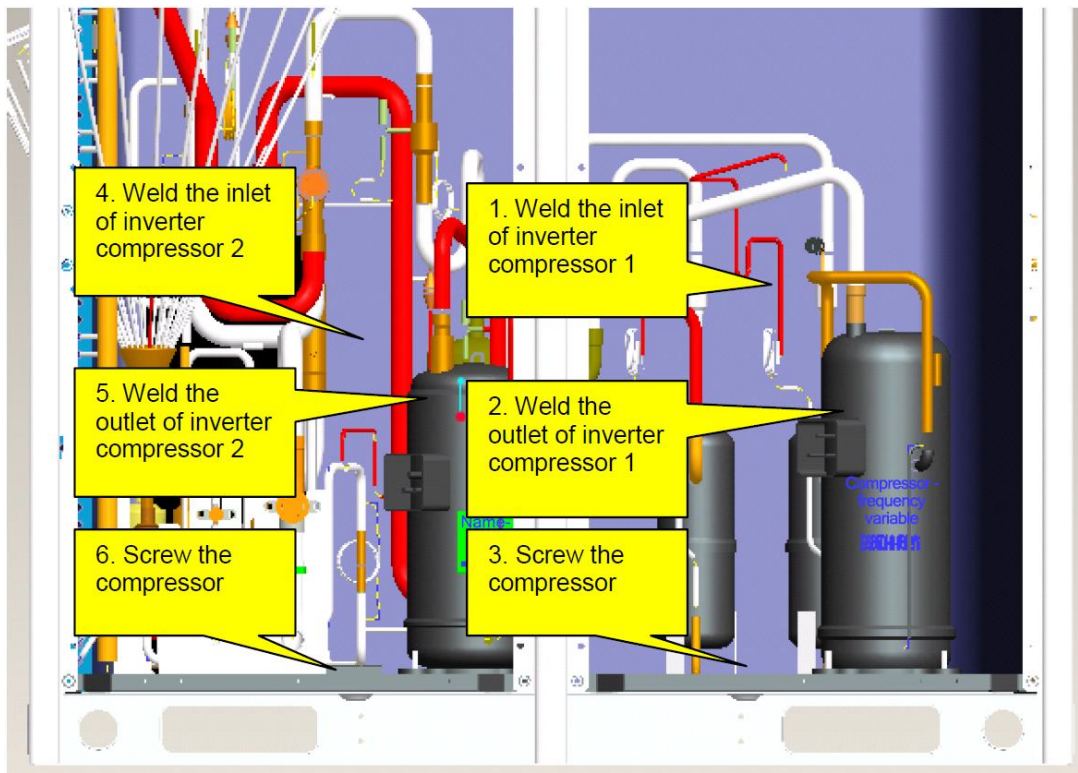

**NOTE:** Keep wiring identical to factory installation. Control varies with compressors. Wrong wiring

or inverse connection of the compressors may cause damage to units.

Cautions on replacement of compressors:

- 1) Before installing new compressors, remove the sealing rubbers and weld the compressors with corresponding pipes. During welding, charge nitrogen into the pipes. Since compressors' suction and discharge pipes are made of copper plated steels, you need to prepare special welding rods (containing 5% or more silver). Welding clearance should be controlled within 0.1~0.3mm, avoiding blockage or loose welding. During welding, control pipe openings from being over-heated.
- 2) After the pipeline system is welded, use special supports and bolts to fix the compressors, ensuring stability of the compressors during running.
- 3) Power lines of the compressors should be wired following the factory installation. You can refer to the wiring diagram. Phase sequence error and inverse connection of compressors are not allowed.

#### **Step 12: System check.**

- 1) Check welding joints for abnormalities.
- 2) Charge nitrogen into the system for leakage detection. If you are maintaining ODU's and the IDU system is normal, you can charge nitrogen into the ODU system only. Note that nitrogen should be charged from both the high pressure side and low pressure side. You are advised to charge through all valves. Nitrogen pressure should be larger than 2.0Mpa (290psi). Then, charge soapsuds into the system and check specially the weld joints for leakage.
- 3) Finally, charge nitrogen into the system again for pressure check. Close all valves and keep system pressure up to 4.0Mpa (580psi) for more than 12 hours. If the pressure remains unchanged, you can extract all air. Otherwise, you should find the leakage points first.

While determining system pressure change, take temperature into consideration. For every 1°C (1.8 °F) temperature change, pressure will change by 0.01 MPa (1.45psi) accordingly. Suppose that nitrogen pressure reaches 2.5 MPa (362.5psi) at 30°C(86°F), 12 hours later, temperature decreases to 25°C (77 °F) and pressure decreases to 2.43 MPa (352.4psi) accordingly. The system is regarded qualified despite the pressure decrease.

#### **Step 13: Fill lubricant.**

Quantity of lubricant that is needed is subject to the total draw amount from compressors and parts. The fill amount should be equivalent to the draw amount. If the draw amount is too little or too much, clear all lubricant first and determine fill amount by referring to Appendix 1 (accessory list).

Fill amount is determined by two factors: the number of compressors replaced and the draw amount from each part. For replacement of one compressor, 1.5 L lubricant should be added. The fill amount should be equal to or a little larger than the draw amount.

Specific procedure is as follows:

- 1) GMV5 series units use FVC68D or FV-68H lubricant. Make sure to confirm the trademark of the lubricant first. Lubricant of other trademarks is not allowed.
- 2) Open all valves and extract air for 30 minutes or longer.
- 3) Connect a rubber hose to the oil checking valve at one end. Open the container that holds

lubricant and pour lubricant into a measuring glass. If the glass is too small to hold the lubricant of a required amount, measure the lubricant portion by portion. Record volume of each portion and then put the other end of the rubber hose into the glass.

- 4) Keep on extracting air and open the oil checking valve. The lubricant will be pressed into the low pressure side of units.
- 5) If the lubricant is added portion by portion, close the oil checking valve first and then measure another portion of lubricant. In the course of repeated measuring and adding, keep the extraction action.
- 6) After a required amount of lubricant is added, close the oil checking valve to ensure tightness.

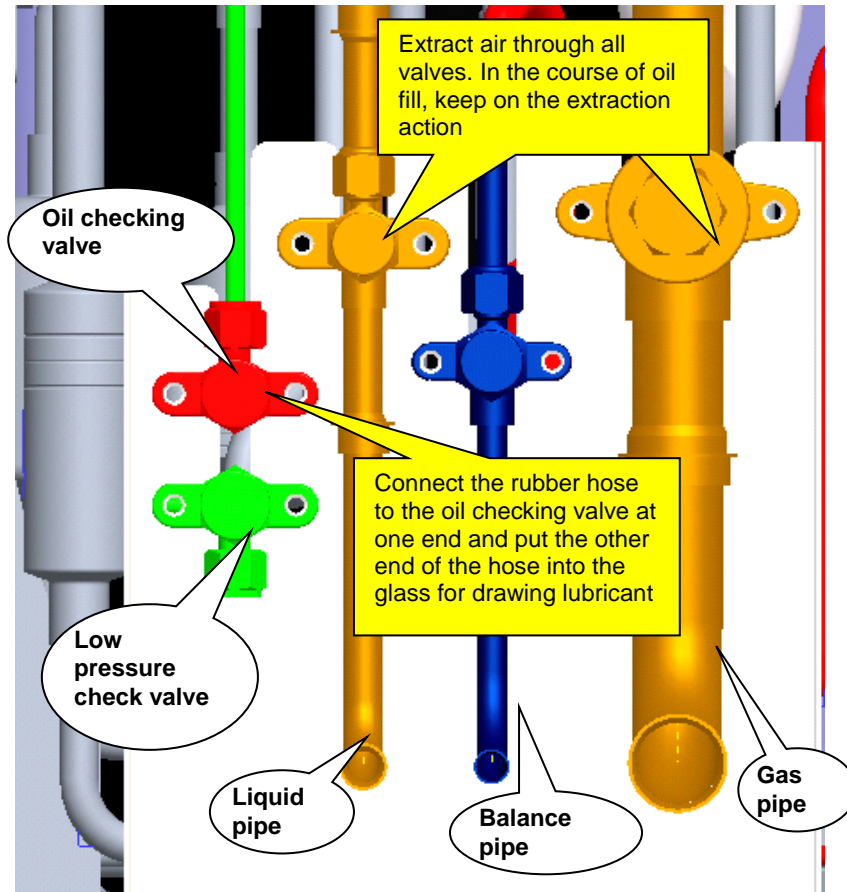

**NOTE:** Lubricant is of great importance to the normal running of compressors. You should follow Gree's requirement to add qualified lubricant of the specified trademark and ensure properness of fill amount.

**Step 14: Vacuum-pump.**

After lubricant is added, keep on extracting air through a vacuum pump till the internal pressure reaches the absolute pressure 0 kgf/cm<sup>2</sup> (0psi) and the pressure gauge reads -1 kgf/cm<sup>2</sup> (-145psi). This is to ensure that moistures inside the pipeline system are completely vaporized.

Vacuum pumps of the specifications below are recommended:

Type	Max. Discharge Rate	Purpose	
		For air discharge	For vacuum drying
Lubricant driven pump	100 L/min	Applicable	Applicable
Lubricant free pump	50 L/min	Applicable	Applicable

Open all valves in order that the vacuum pump extracts air through all the valves, during which, connect the units to a pressure gauge. When the internal pressure reaches 0 kgf/cm<sup>2</sup> (0psi) and the

pressure gauge reads  $-1 \text{ kgf/cm}^2$  ( $-145\text{psi}$ ), keep on the extraction action for  $0.5\sim 1.0$  hour more. Finally, turn off the rotary switch of the gauge and close the pump. One hour later, if the pressure remains the same, fill refrigerant. If the pressure increases to  $0.1 \text{ kgf/cm}^2$  ( $14.5\text{psi}$ ) or higher, conduct leakage check again.

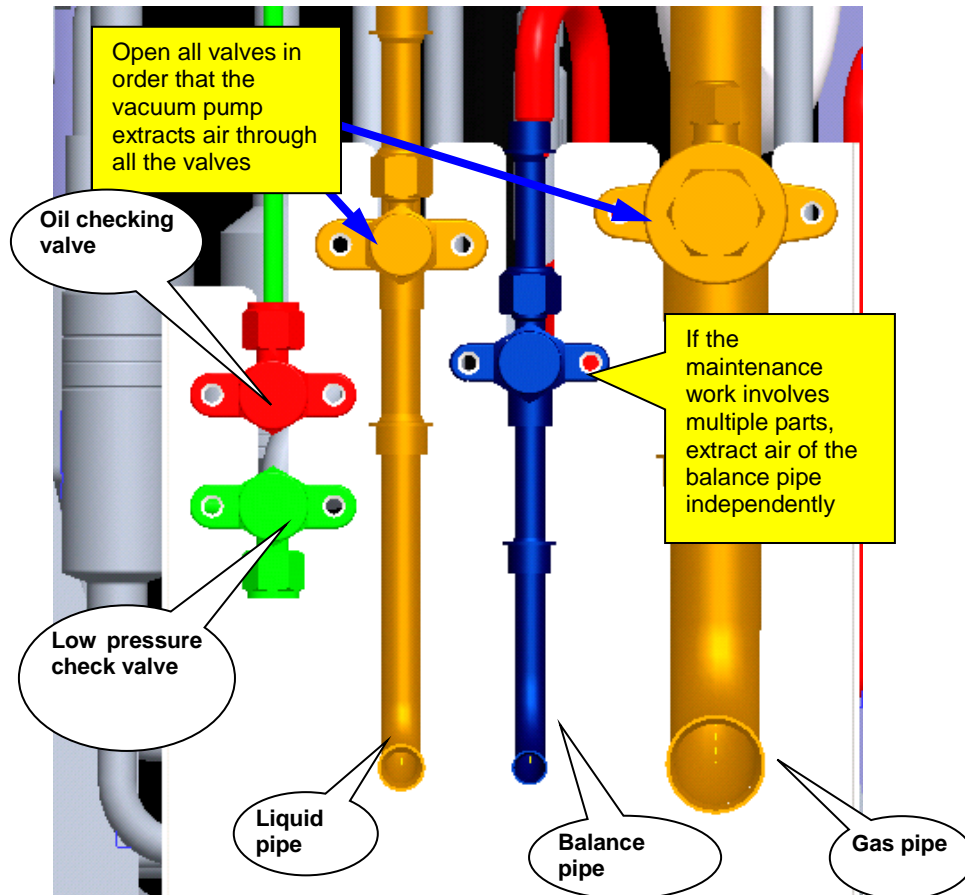

### Step 15: Fill refrigerant.

Before filling refrigerant, check its manufacturer, package, and print information. Besides, check refrigerant pressure and quality against the saturation pressure / temperature list.

1) Measure and check the pressure of the entire refrigerant product against the saturation pressure / temperature list. Verify temperature parameter. If the difference between the actual temperature and the parameter value is  $3^{\circ}\text{C}$  ( $5.4^{\circ}\text{F}$ ) or more, the refrigerant quality is unsatisfactory.

2) If the refrigerant is proved satisfactory, fill refrigerant of the combined amount of the rated amount (specified on the nameplate) and the calculated refrigerant loss amount.

For a multi-modular unit system, if only the refrigerant of an ODU is drawn out, add 80% refrigerant of the rated fill amount (specified on the nameplate of the ODU) and start the system for a debugging test.

### Step 16: Install electric parts.

Install the electric box and connect various parts to the electric box by referring to the marks made beforehand and the wiring diagram on the back of the box. Wire the compressors and corresponding electric heating belts.

**NOTE:** Wires should be checked against the wiring diagram beforehand so that they can be connected correctly.

### Step 17: Start for debugging.

Start the units and set them to run in refrigerating full-start, refrigerating single-start, heating full-start, and heating single-start modes respectively. Duration for each running mode should be 30 minutes at least. After the debug, analyze data and adjust the unit system, to ensure indexes of the entire system. For details about each index, please consult after-sale persons and technicians.

### 3.3 CAUTIONS ON COMPRESSOR DRIVE REPLACEMENT

- (1) Disconnect the power supply of the system. Set a multimeter to the AC voltage gear and measure voltage between two of the lines (L1, L2, L3, and N). The measuring result should be 0 V (sometimes, multimeters may be faulty and read false values). Set a mark beside the power supply for warning.
- (2) Measure compressor drive DC bus voltage between two wire terminals of P, U, V, W and N. Set the multimeter to the DC voltage gear and measure the voltage between P and N. The voltage should be lower than 36 V. If no multimeter is available, wait for 20 minutes before performing the steps below.

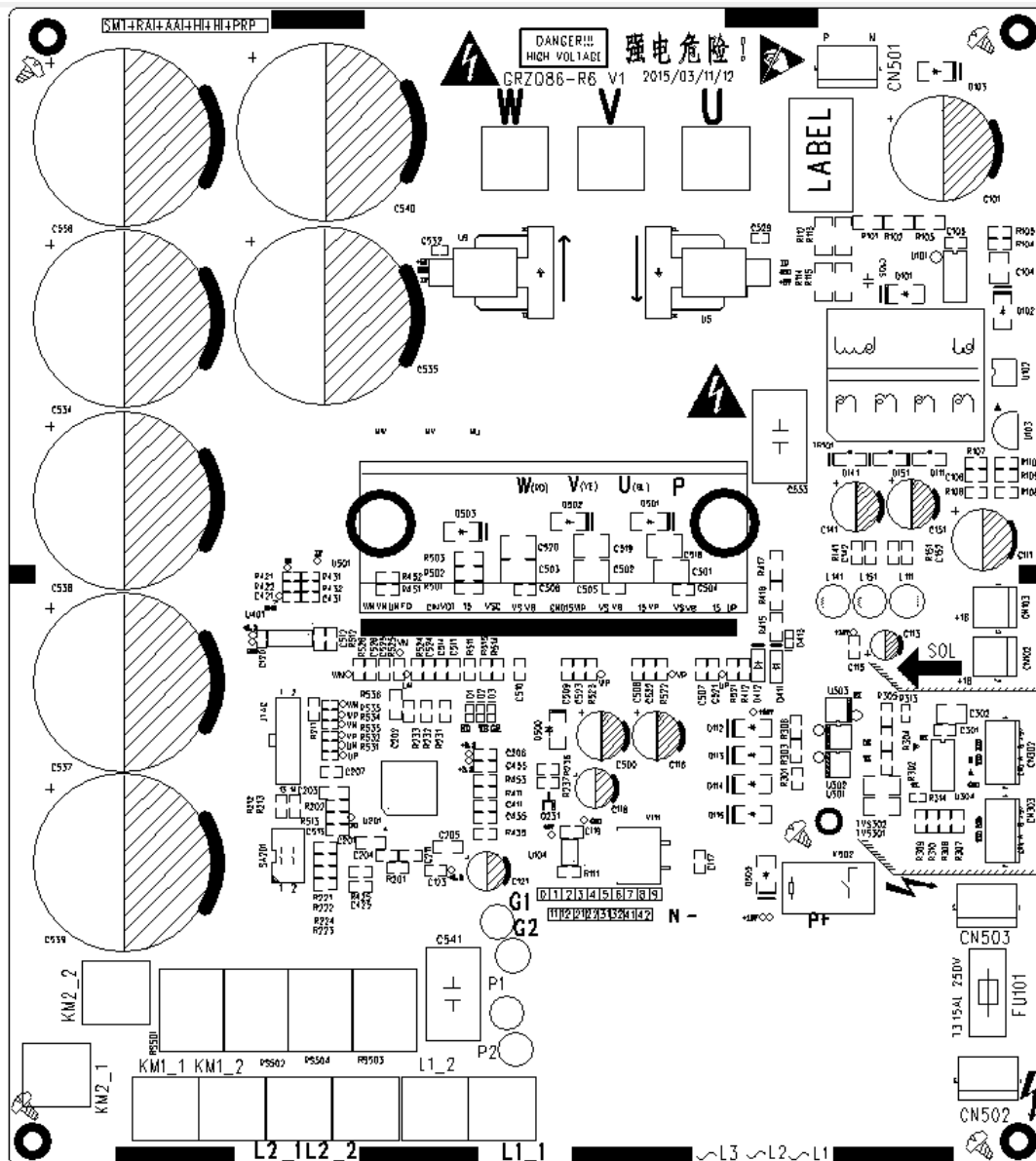

- (3) Disconnect all lines of the compressor drive, including: compressor line; communication line between the master unit and the drive; communication line between the compressor drive and

fan drive; compressor drive output 18 VDC; bridge rectifier output P; bridge rectifier output N; compressor drive output 540 VDC; reactor's wiring terminal; bridge rectifier input AC inlead; compressor drive's mains terminal. See the figure below:

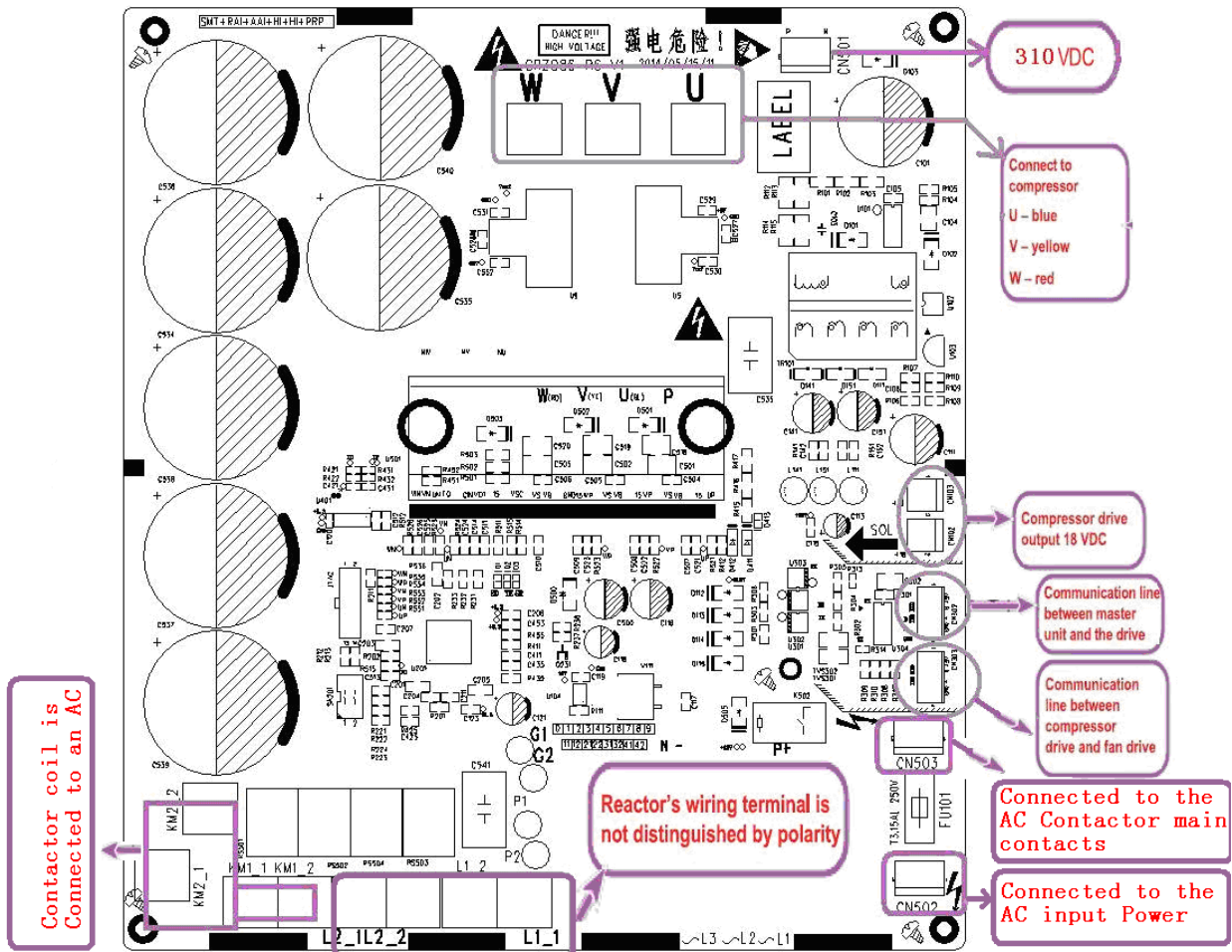





- (5) Replace the compressor drive. Before the replacement, apply some silicone tape onto the IPM module.

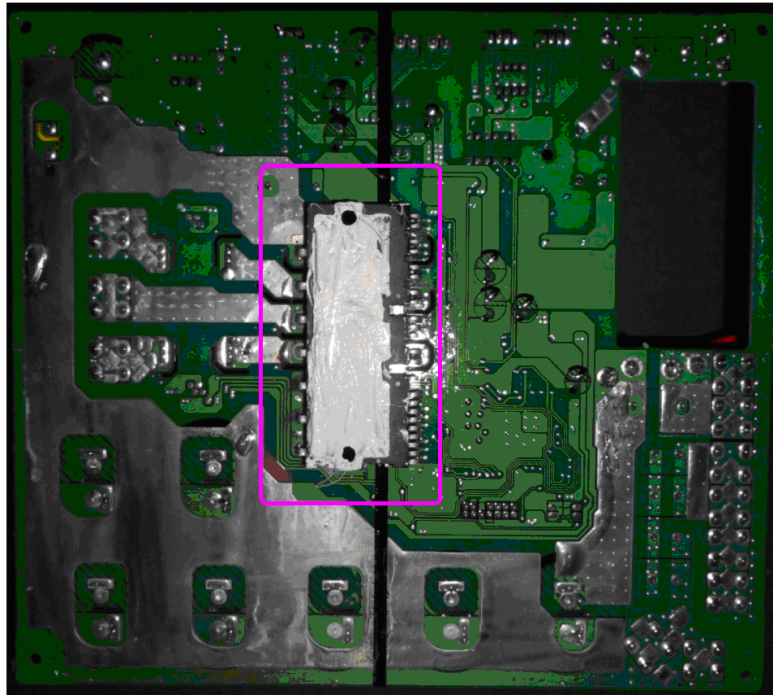

- (6) Install a new compressor drive, screw and wire it.

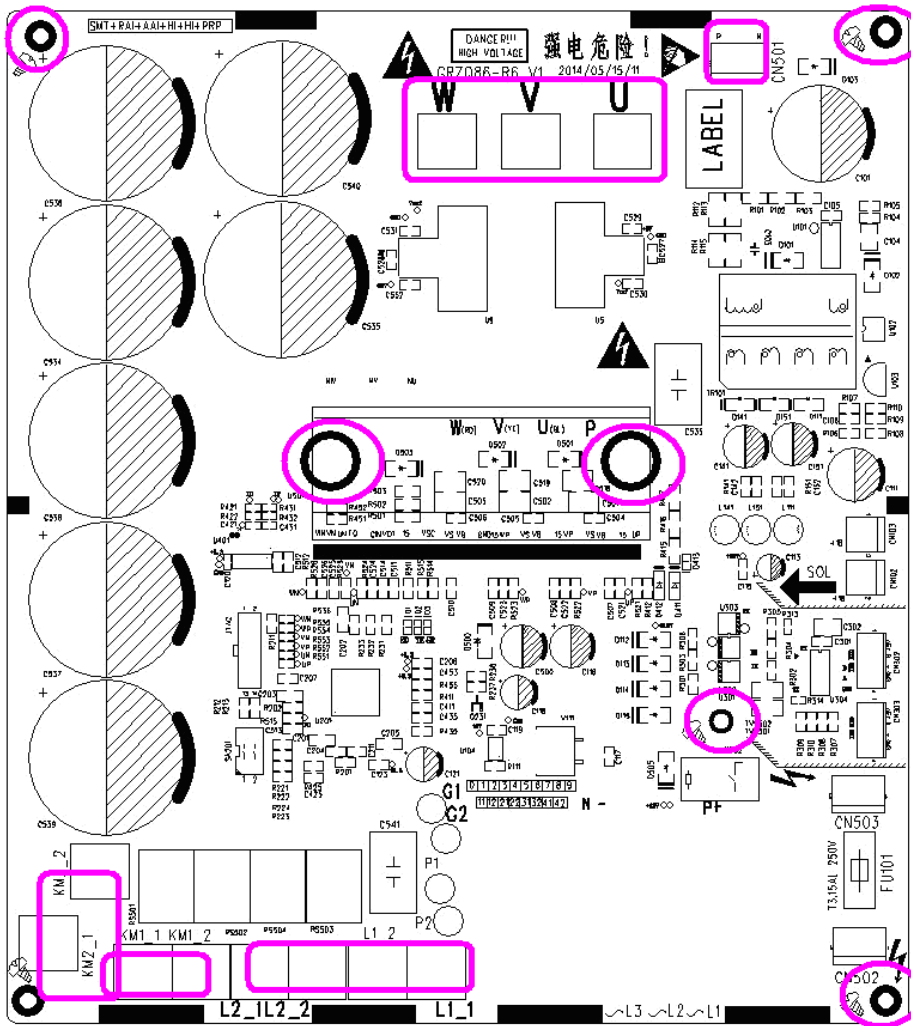

### 3.4 ASSEMBLING AND DISASSEMBLING KEY PARTS OF ODUS

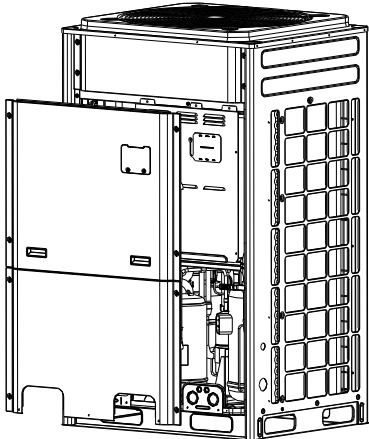
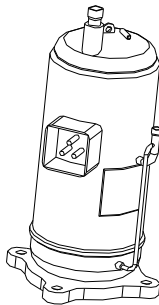
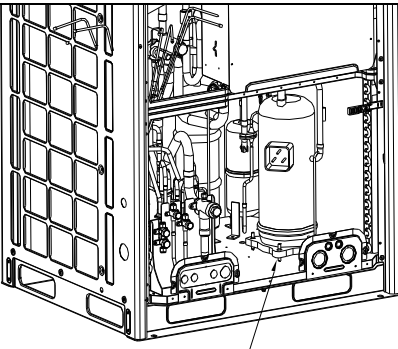
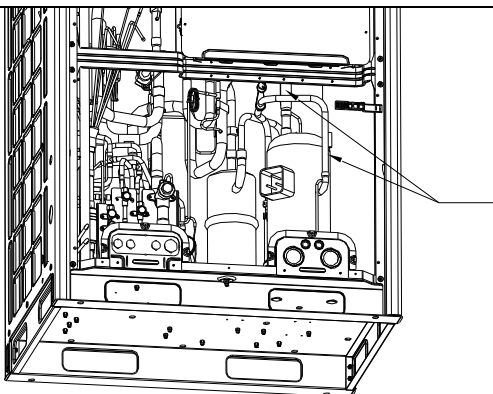
Compressor		
Precondition: No refrigerant exists in the pipeline system and the power supply has been disconnected.		
Step	Diagram	Operation Procedure
1. Remove the front panels.		<ul style="list-style-type: none"> <li>●Use a screwdriver to unscrew the upper and lower front panels.</li> <li>●Lift the front panels in order to take it out.</li> </ul> <p>Note: Both the upper panel and lower panel are fixed with two fasteners respectively to connect to the side panels.</p>
2. Disconnect the power line of the compressor, and remove the electric heating belt, top temperature sensor, and discharge air temperature sensor.		<ul style="list-style-type: none"> <li>●Remove the sound-proof sponge from the compressor.</li> <li>●Use a screwdriver to unscrew the power line.</li> <li>●Remove the power line.</li> <li>●Remove the electric heating belt, top temperature sensor, and discharge air temperature sensor.</li> </ul> <p>Note: Before removing the power line, mark the colours of the line and corresponding wiring terminals.</p>
3. Loosen the nuts of the compressor.		<ul style="list-style-type: none"> <li>●Use a wrench to unscrew the four nuts.</li> </ul>
4. Remove the suction and discharge pipes.		<ul style="list-style-type: none"> <li>●Heat the suction and discharge pipes by acetylene welding and then remove the pipes.</li> <li>●During welding, charge nitrogen into the pipes. The pressure should be controlled within <math>0.5 \pm 0.1</math> kgf/cm<sup>2</sup> (relative pressure).</li> <li>●Avoid nearby materials from being burnt during welding.</li> </ul>

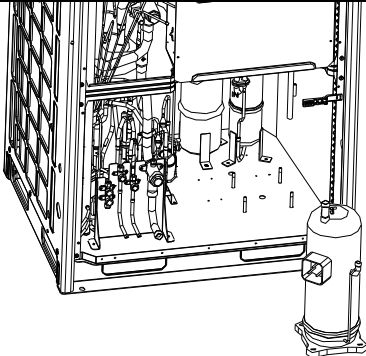
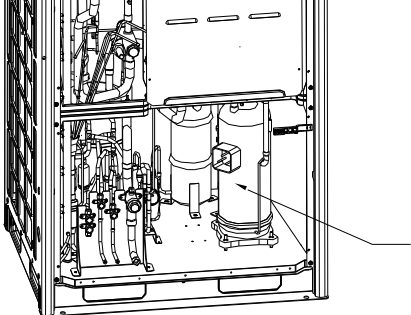
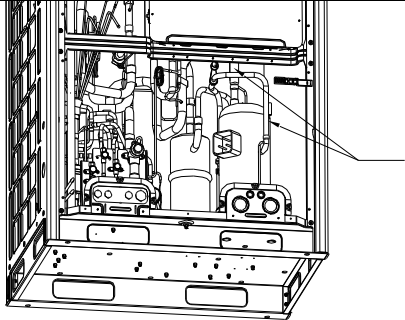
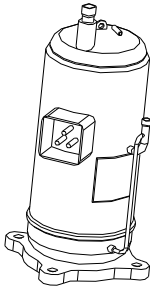
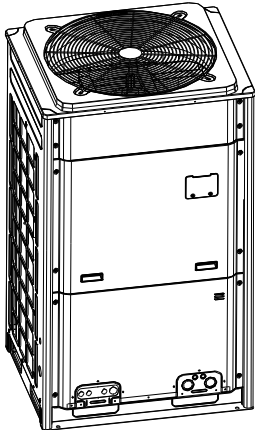
Compressor		
Precondition: No refrigerant exists in the pipeline system and the power supply has been disconnected.		
Step	Diagram	Operation Procedure
5. Remove the compressor.		<ul style="list-style-type: none"> <li>●Remove the compressor from the chassis.</li> </ul>
6. Install a new compressor on the chassis.		<ul style="list-style-type: none"> <li>●Put the compressor in a proper position.</li> <li>●Use a wrench to screw the nuts on the compressor.</li> <li>●The compressor should not be installed upside down.</li> </ul>
7. Connect the suction and discharge pipes of the compressor to the pipeline system.		<ul style="list-style-type: none"> <li>●Heat the suction and discharge pipes by acetylene welding and then install the pipes.</li> <li>●During welding, charge nitrogen into the pipes. The pressure should be controlled within <math>0.5 \pm 0.1</math> kgf/cm<sup>2</sup> (relative pressure).</li> <li>●Avoid nearby materials from being burnt during welding.</li> </ul>
8. Connect the power line to the compressor, and install the electric heating belt, top temperature sensor, and discharge air temperature sensor.		<ul style="list-style-type: none"> <li>●Put the power line in a proper position.</li> <li>●Use a screwdriver to screw the power line.</li> <li>●Install the electric heating belt, top temperature sensor, and discharge air temperature sensor.</li> <li>●Put the sound-proof sponge back to position.</li> </ul>
9. Check and then install the front panels.		<ul style="list-style-type: none"> <li>●Check various parts and connecting lines.</li> <li>●If no problem is found, hook the front panels and tighten the screws.</li> </ul>

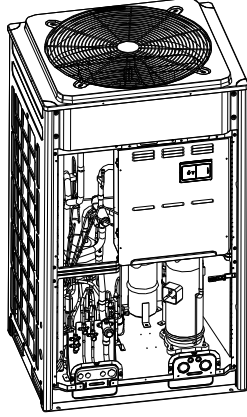
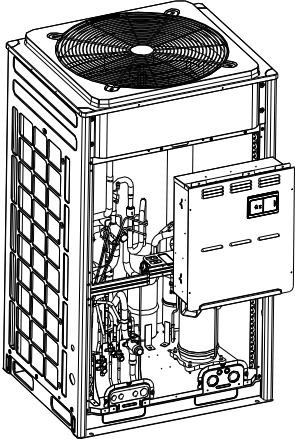
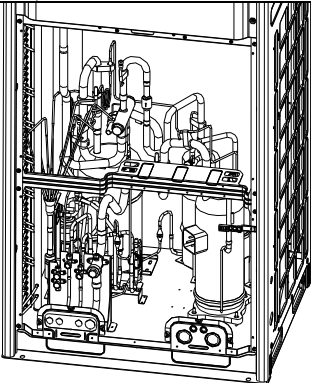
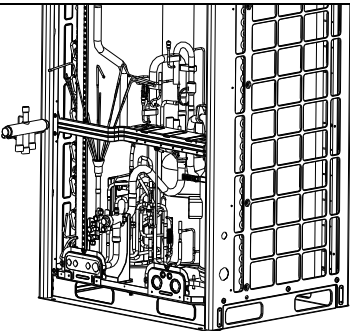
Four-way valve		
Precondition: No refrigerant exists in the pipeline system and the power supply has been disconnected.		
Step	Diagram	Operation Procedure
1. Loosen the hooks at the bottom of the electric box and the screws.		<ul style="list-style-type: none"> <li>●Remove the upper and lower front panels.</li> <li>●Loosen the hooks at the bottom of the electric box.</li> <li>●Use a screwdriver to unscrew the electric box.</li> </ul>
2. Remove the electric box.		<ul style="list-style-type: none"> <li>●Disconnect internal and external connecting lines of the electric box.</li> <li>●Protect the internal parts during the disassembly.</li> </ul>
3. Disassemble the four-way valve.		<p>Use a screwdriver to unscrew accessories of the four-way valve. Remove the accessories.</p> <ul style="list-style-type: none"> <li>●Heat the connecting pipes of the four-way valve by acetylene welding and then remove the pipes.</li> <li>●Record the direction of the valve and position of the pipe joints.</li> </ul> <p>Note: Avoid nearby parts from being burnt during welding.</p>
4. Remove the four-way valve.		<ul style="list-style-type: none"> <li>●Remove the four-way valve from the pipeline.</li> </ul>

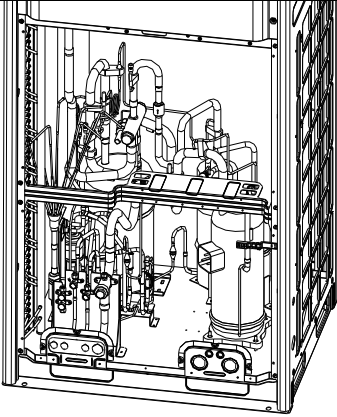
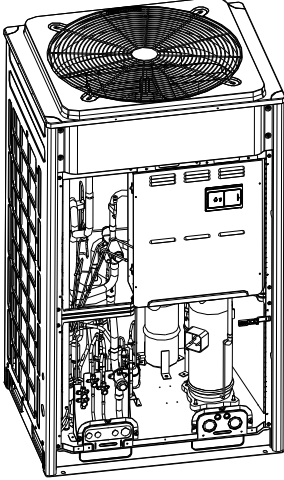
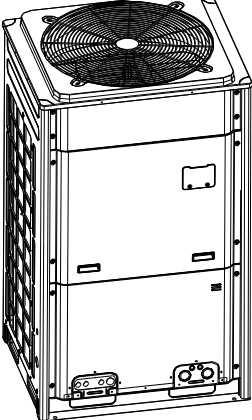
Four-way valve		
Precondition: No refrigerant exists in the pipeline system and the power supply has been disconnected.		
Step	Diagram	Operation Procedure
<p>5. Install a new four-way valve.</p>		<ul style="list-style-type: none"> <li>●Put the valve in a proper position.</li> <li>●Weld the valve with the pipeline.</li> <li>●Before welding, cover the valve with wet cloth to avoid internal slide from being burnt and prevent water from flowing in the pipeline.</li> <li>●During welding, charge nitrogen into the pipes. The pressure should be controlled within <math>0.5\pm 0.1</math> kgf/cm<sup>2</sup> (relative pressure).</li> </ul>
<p>6. Fix and wire the electric box.</p>		<ul style="list-style-type: none"> <li>●Put the electric box back to original position and screw it.</li> <li>●Connect all lines.</li> </ul>
<p>7. Check and install the front panels.</p>		<ul style="list-style-type: none"> <li>●Check various parts and connecting lines.</li> <li>●If no problem is found, hook the front panels and tighten the screws.</li> </ul>

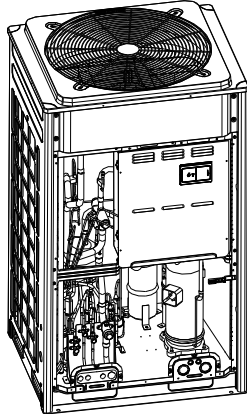
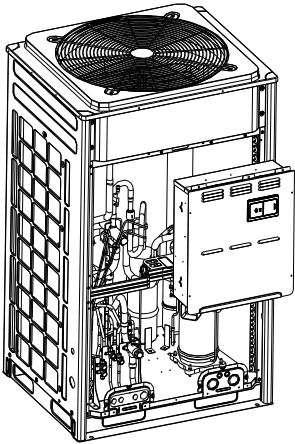
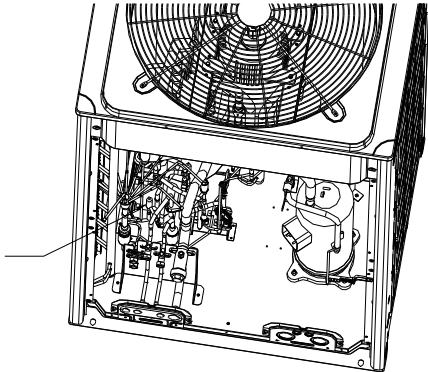
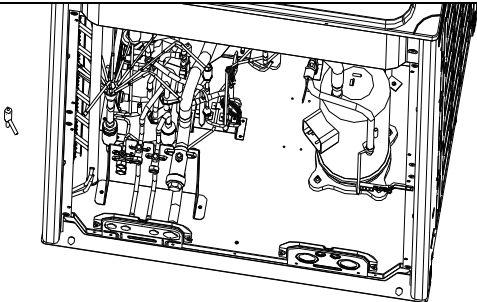
Electric expansion valve		
Precondition: No refrigerant exists in the pipeline system and the power supply has been disconnected.		
Step	Diagram	Operation Procedure
1. Loosen the hooks at the bottom of the electric box and the screws.		<ul style="list-style-type: none"> <li>●Remove the upper and lower front panels.</li> <li>●Loosen the hooks at the bottom of the electric box.</li> <li>●Use a screwdriver to unscrew the electric box.</li> </ul>
2. Remove the electric box.		<ul style="list-style-type: none"> <li>●Disconnect internal and external connecting lines of the electric box.</li> <li>●Protect the internal parts during the disassembly.</li> </ul>
3. Disassemble the electric expansion valve.		<ul style="list-style-type: none"> <li>●Remove the coil from the electric expansion valve.</li> <li>●Heat the connecting pipes of the electric expansion valve by welding and remove the pipes.</li> </ul> <p>Note: Avoid nearby parts from being burnt during welding.</p>
4. Remove the electric expansion valve.		<ul style="list-style-type: none"> <li>●Remove the electric expansion valve.</li> </ul>

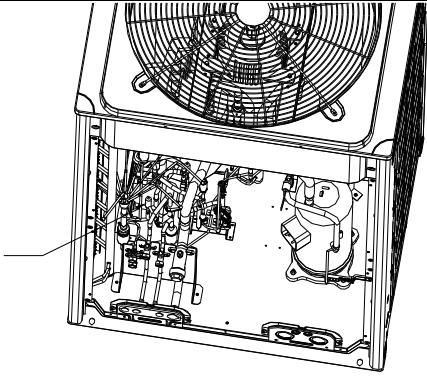
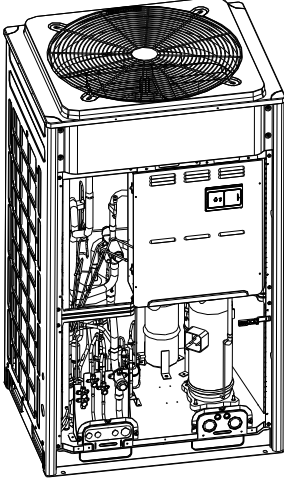
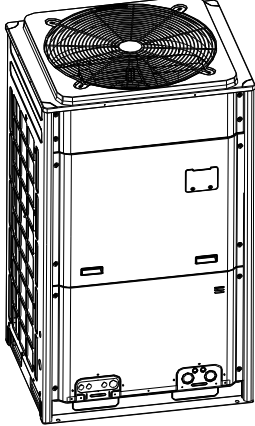
Electric expansion valve		
Precondition: No refrigerant exists in the pipeline system and the power supply has been disconnected.		
Step	Diagram	Operation Procedure
5. Install a new electric expansion valve.		<ul style="list-style-type: none"> <li>●Weld the connecting pipes with the electric expansion valve.</li> <li>●Before welding, cover the valve with wet cloth.</li> <li>●During welding, charge nitrogen into the pipes. The pressure should be controlled within <math>0.5\pm 0.1</math> kgf/cm<sup>2</sup> (relative pressure).</li> </ul> <p>Note: Avoid nearby parts from being burnt during welding.</p> <ul style="list-style-type: none"> <li>●Install the coil on the electric expansion valve.</li> </ul>
6. Fix and wire the electric box.		<ul style="list-style-type: none"> <li>●Put the electric box back to original position and screw it.</li> <li>●Connect all lines.</li> </ul>
7. Check and install the front panels.		<ul style="list-style-type: none"> <li>●Check various parts and connecting lines.</li> <li>●If no problem is found, hook the front panels and tighten the screws.</li> </ul>

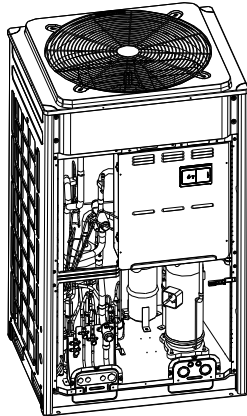
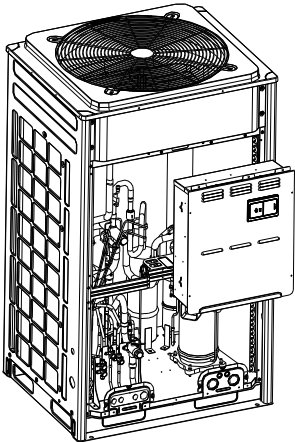
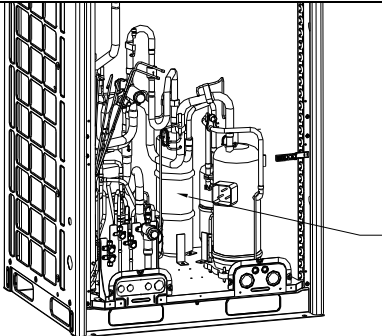
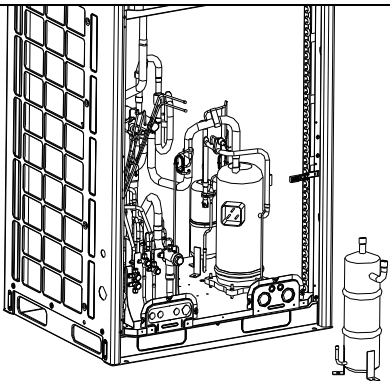

Oil separator		
Precondition: No refrigerant exists in the pipeline system and the power supply has been disconnected.		
Step	Diagram	Operation Procedure
<p>1. Loosen the hooks at the bottom of the electric box and the screws.</p>		<ul style="list-style-type: none"> <li>●Remove the upper and lower front panels.</li> <li>●Loosen the hooks at the bottom of the electric box.</li> <li>●Use a screwdriver to unscrew the electric box.</li> </ul>
<p>2. Remove the electric box.</p>		<ul style="list-style-type: none"> <li>●Disconnect internal and external connecting lines of the electric box.</li> <li>●Protect the internal parts during the disassembly.</li> </ul>
<p>3. Disassemble the oil separator.</p>		<ul style="list-style-type: none"> <li>●Use a screwdriver to unscrew the oil separator.</li> <li>●Loosen the electric heating belt.</li> <li>●Heat the four pipe joints of the oil separator by welding and remove the connecting pipes.</li> </ul> <p>Note: Avoid nearby parts from being burnt during welding.</p>
<p>4. Remove the oil separator.</p>		<ul style="list-style-type: none"> <li>●Remove the oil separator from the chassis.</li> </ul>

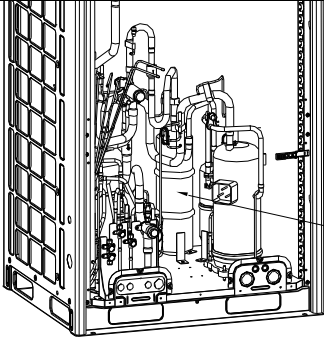
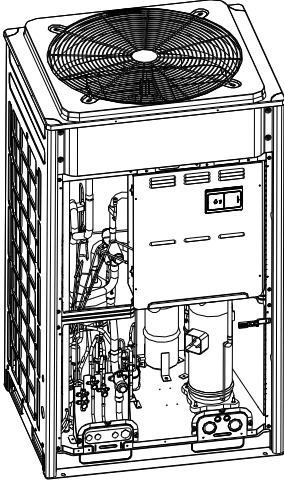
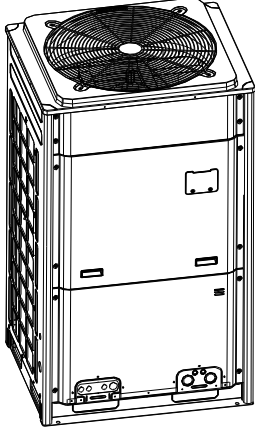
Oil separator		
Precondition: No refrigerant exists in the pipeline system and the power supply has been disconnected.		
Step	Diagram	Operation Procedure
5. Install a new oil separator.		<ul style="list-style-type: none"> <li>●Weld the four pipe joints with the oil separator.</li> </ul> <p>During welding, charge nitrogen into the pipes. The pressure should be controlled within <math>0.5\pm 0.1</math> kgf/cm<sup>2</sup> (relative pressure).</p> <p>Note: Avoid nearby parts from being burnt during welding.</p> <ul style="list-style-type: none"> <li>●Screw the oil separator.</li> <li>●Tighten the electric heating belt.</li> </ul>
6. Fix and wire the electric box.		<ul style="list-style-type: none"> <li>●Put the electric box back to original position and screw it.</li> <li>●Connect all lines.</li> </ul>
7. Check and install the front panels.		<ul style="list-style-type: none"> <li>●Check various parts and connecting lines.</li> <li>●If no problem is found, hook the front panels and tighten the screws.</li> </ul>

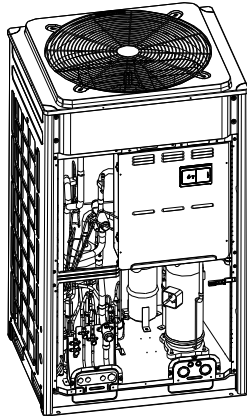
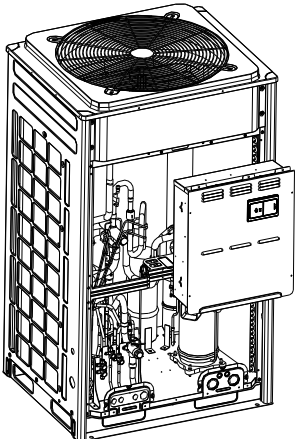
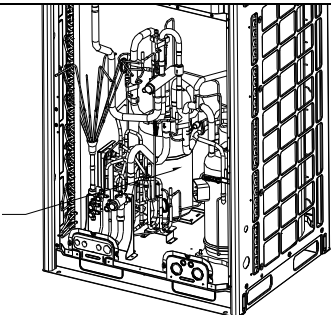
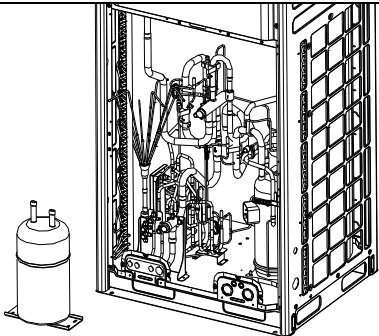
Gas/liquid separator		
Precondition: No refrigerant exists in the pipeline system and the power supply has been disconnected.		
Step	Diagram	Operation Procedure
1. Loosen the hooks at the bottom of the electric box and the screws.		<ul style="list-style-type: none"> <li>●Remove the upper and lower front panels.</li> <li>●Loosen the hooks at the bottom of the electric box.</li> <li>●Use a screwdriver to unscrew the electric box.</li> </ul>
2. Remove the electric box.		<ul style="list-style-type: none"> <li>●Disconnect internal and external connecting lines of the electric box.</li> <li>●Protect the internal parts during the disassembly.</li> </ul>
3. Disassemble the gas/liquid separator.		<ul style="list-style-type: none"> <li>●Heat the connecting pipes of the gas/liquid separator by acetylene welding and then remove the pipes. Note: Avoid nearby parts from being burnt during welding.</li> </ul>
4. Remove the gas/liquid separator.		<ul style="list-style-type: none"> <li>●Unscrew and remove the gas/liquid separator.</li> </ul>

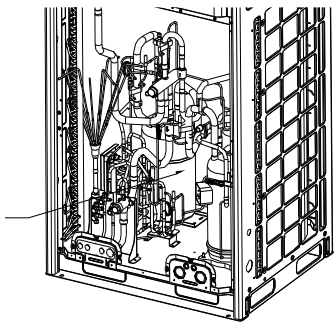
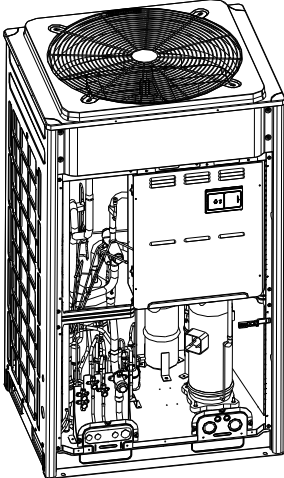
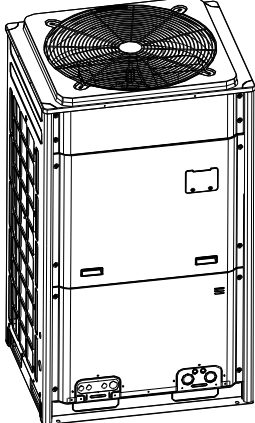
Gas/liquid separator		
Precondition: No refrigerant exists in the pipeline system and the power supply has been disconnected.		
Step	Diagram	Operation Procedure
5. Install a new gas/liquid separator.		<ul style="list-style-type: none"> <li>●Put the gas/liquid separator based on the position of the suction and discharge pipes and weld the pipes with the gas/liquid separator.</li> <li>●During welding, charge nitrogen into the pipes. The pressure should be controlled within <math>0.5 \pm 0.1</math> kgf/cm<sup>2</sup> (relative pressure).</li> </ul> <p>Note: Avoid nearby parts from being burnt during welding.</p> <ul style="list-style-type: none"> <li>●Screw the gas/liquid separator.</li> </ul>
6. Fix and wire the electric box.		<ul style="list-style-type: none"> <li>●Put the electric box back to original position and screw it.</li> <li>●Connect all lines.</li> </ul>
7. Check and install the front panels.		<ul style="list-style-type: none"> <li>●Check various parts and connecting lines.</li> <li>●If no problem is found, hook the front panels and tighten the screws.</li> </ul>

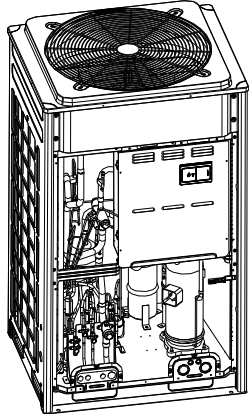
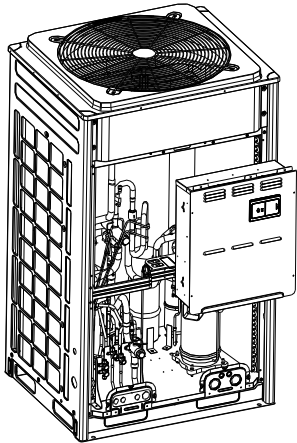
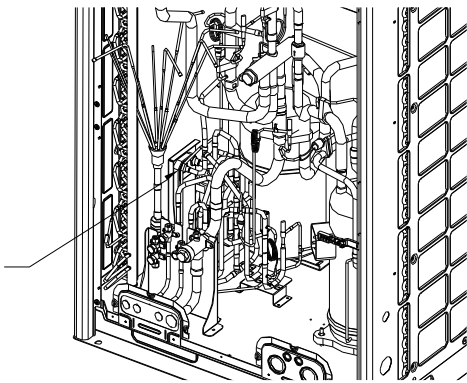
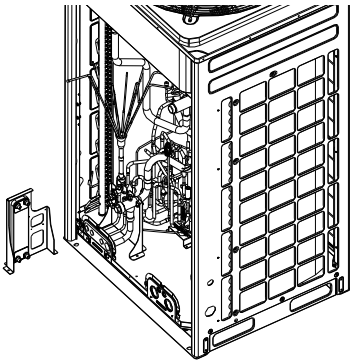
Heat exchanging board		
Precondition: No refrigerant exists in the pipeline system and the power supply has been disconnected.		
Step	Diagram	Operation Procedure
1. Loosen the hooks at the bottom of the electric box and the screws.		<ul style="list-style-type: none"> <li>●Remove the upper and lower front panels.</li> <li>●Loosen the hooks at the bottom of the electric box.</li> <li>●Use a screwdriver to unscrew the electric box.</li> </ul>
2. Remove the electric box.		<ul style="list-style-type: none"> <li>●Disconnect internal and external connecting lines of the electric box.</li> <li>●Protect the internal parts during the disassembly.</li> </ul>
3. Disassemble the heat exchanging board.		<ul style="list-style-type: none"> <li>●Heat the connecting pipes of the heat exchanging board by acetylene welding and then remove the pipes. Note: Avoid nearby parts from being burnt during welding. The joints of the board must be welded with copper plated steel. Ensure welding quality.</li> </ul>
4. Remove the heat exchanging board.		<ul style="list-style-type: none"> <li>●Unscrew the support of the heat exchanging board, and remove the support and board.</li> </ul>

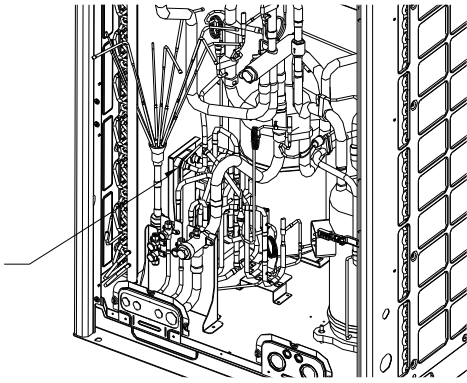
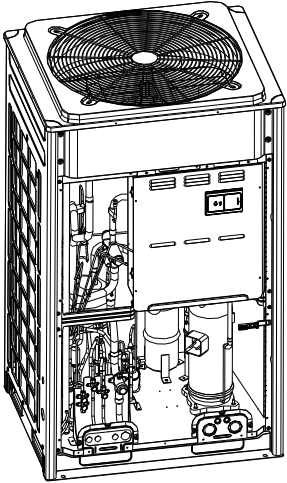
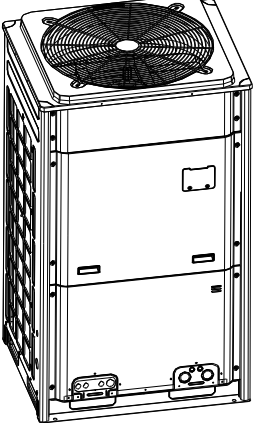
Heat exchanging board		
Precondition: No refrigerant exists in the pipeline system and the power supply has been disconnected.		
Step	Diagram	Operation Procedure
5. Install a new heat exchanging board.		<ul style="list-style-type: none"> <li>●Screw the support of the heat exchanging board and fix the board onto the chassis.</li> <li>●Put the heat exchanging board based on the position of the suction and discharge pipes and weld the pipes with the heat exchanging board.</li> <li>●During welding, charge nitrogen into the pipes. The pressure should be controlled within <math>0.5\pm 0.1</math> kgf/cm<sup>2</sup> (relative pressure).</li> </ul> <p>Note: Avoid nearby parts from being burnt during welding.</p>
6. Fix and wire the electric box.		<ul style="list-style-type: none"> <li>●Put the electric box back to original position and screw it.</li> <li>●Connect all lines.</li> </ul>
7. Check and install the front panels.		<ul style="list-style-type: none"> <li>●Check various parts and connecting lines.</li> <li>●If no problem is found, hook the front panels and tighten the screws.</li> </ul>

## 3.5 UNIT MAINTENANCE

Check and maintain the unit periodically can prolong the service life of the unit. Please appoint professional person to conduct the maintenance.

### 3.5.1 ODU Heat Exchanger

ODU heat exchangers should be cleaned regularly, two months a time at least. Use an absorber and nylon brush to clear surface dusts and stains. If a compressed air ejector is available, spray the heat exchanger with the ejector to clear the dirt. Water is prohibited.

### 3.5.2 Discharge Pipe

Periodically check discharge pipes for blockage to make condensing water discharged freely.

### 3.5.3 Pre-Season Cautions

- (1) Check IDU and ODUs' air inlets and outlets for blockage.
- (2) Check whether they are properly earthed.
- (3) Check batteries of the remote control.
- (4) Check whether air filters have been properly installed.
- (5) Turn the power switch on 8 hours beforehand to pre-heat the outdoor compressor crankcase before the unit is restarted after being in idle status for a long time.
- (6) Check ODU installation. If an abnormality is found, contact GREE's special maintenance center.

### 3.5.4 Post-Season Maintenance

- (1) Disconnect the general power supply.
- (2) Clean air filters and ODUs.
- (3) Clear dusts and stains off IDUs and ODUs.
- (4) For rusty ODUs, apply some paint on them to prevent deterioration.

### 3.5.5 Parts Replacement

Contact GREE's local office or dealers to obtain parts.

**Note:** In the course of air tightness and leakage test, prevent oxygen or acetylene from entering cooling circuits. Nitrogen or refrigerant is recommended.

## 4 APPENDIXES

### 4.1 MINUTES ABOUT A DEBUG SOLUTION CONFIRMATION MEETING

Confirming air conditioner debug solution to the *** project	
Theme: ***	
Time: ***	
Place: ***	
Participants: ***	
Contents: ***	
1	
2	
3	

### 4.2 VISUAL INSPECTION CHECKLIST OF THE DEBUG SYSTEM

Visual inspection checklist of *** air conditioning equipment				
Item		Problem	Checked by	Check time
Refrigerating system	Appearance of ODUs			
	Appearance of IDUs			
	Thermal insulation of copper pipes			
Discharge system	Thermal insulation of condensing pipes			
Electric system	Power line diameter			
	Cabling of power lines			

Visual inspection checklist of *** air conditioning equipment				
Item	Problem	Checked by	Check time	
Air circuit breaker				
Communication system	Materials of communication lines			
	Connection of communication lines			

### 4.3 DEBUG PARAMETER RECORD LIST

Project name				Unit model			
Debugged by				Date			
ODU rated capacity (kW)		General IDU rated capacity (kW)		Total length of refrigerant pipes (m)			
Maximum fall of IDUs (m)				Fill amount of refrigerant (kg)			
Debug state: Refrigerating Heating Number and capacity of running IDUs							
State parameter		Unit	Prestart	30min	60min	90min	
ODU	Outdoor temperature	°F					
	Power voltage	V					
	Frequency	Hz					
	Compressor current	A					
	Discharge temperature	°F					
	System temperature under high pressure	°F					
	System temperature under low pressure	°F					
1# IDU	Rated capacity	kW					
	Ambient temperature	°F					
	IDU gear	Gear					
	Outlet temperature	°F					
	Outlet speed	M/S					
	Noise	dB					
	Water tray	—					
2# IDU	Rated capacity	kW					
	Ambient temperature	°F					
	IDU gear	Gear					
	Outlet temperature	°F					
	Outlet speed	M/S					
	Noise	dB					
	Water tray	—					



## 4.4 COMMON PARAMETER LISTS

### 4.4.1 R410A refrigerant pressure / saturation temperature list

Temperature		Corresponding saturation pressure		Temperature		Corresponding saturation pressure		Temperature		Corresponding saturation pressure	
°C	°F	BAR	psi	°C	°F	BAR	psi	°C	°F	BAR	psi
-43	-45.4	1.54	22.34	-9	15.8	5.97	86.59	25	77.0	16.64	241.34
-42	-43.6	1.61	23.35	-8	17.6	6.18	89.63	26	78.8	17.08	247.72
-41	-41.8	1.68	24.37	-7	19.4	6.39	92.68	27	80.6	17.54	254.40
-40	-40.0	1.76	25.53	-6	21.2	6.61	95.87	28	82.4	18.01	261.21
-39	-38.2	1.84	26.69	-5	23.0	6.84	99.21	29	84.2	18.48	268.03
-38	-36.4	1.93	27.99	-4	24.8	7.07	102.54	30	86.0	18.97	275.14
-37	-34.6	2.02	29.30	-3	26.6	7.30	105.88	31	87.8	19.46	282.24
-36	-32.8	2.11	30.60	-2	28.4	7.54	109.36	32	89.6	19.96	289.50
-35	-31.0	2.20	31.91	-1	30.2	7.79	112.98	33	91.4	20.48	297.04
-34	-29.2	2.30	33.36	0	32.0	8.04	116.61	34	93.2	21.00	304.58
-33	-27.4	2.40	34.81	1	33.8	8.30	120.38	35	95.0	21.53	312.27
-32	-25.6	2.50	36.26	2	35.6	8.57	124.30	36	96.8	22.08	320.24
-31	-23.8	2.61	37.85	3	37.4	8.84	128.21	37	98.6	22.63	328.22
-30	-22.0	2.72	39.45	4	39.2	9.12	132.27	38	100.4	23.20	336.49
-29	-20.2	2.83	41.05	5	41.0	9.40	136.34	39	102.2	23.77	344.75
-28	-18.4	2.95	42.79	6	42.8	9.69	140.54	40	104.0	24.36	353.31
-27	-16.6	3.07	44.53	7	44.6	9.99	144.89	41	105.8	24.95	361.87
-26	-14.8	3.19	46.27	8	46.4	10.30	149.39	42	107.6	25.56	370.72
-25	-13.0	3.32	48.15	9	48.2	10.61	153.89	43	109.4	26.18	379.71
-24	-11.2	3.45	50.04	10	50.0	10.93	158.53	44	111.2	26.81	388.85
-23	-9.4	3.59	52.07	11	51.8	11.25	163.17	45	113.0	27.45	398.13
-22	-7.6	3.73	54.10	12	53.6	11.59	168.10	46	114.8	28.10	407.56
-21	-5.8	3.88	56.27	13	55.4	11.93	173.03	47	116.6	28.76	417.13
-20	-4.0	4.03	58.45	14	57.2	12.28	178.11	48	118.4	29.44	426.99
-19	-2.2	4.18	60.63	15	59.0	12.63	183.18	49	120.2	30.13	437.00
-18	-0.4	4.34	62.95	16	60.8	13.00	188.55	50	122.0	30.83	447.15
-17	1.4	4.50	65.27	17	62.6	13.37	193.92	52	125.6	32.26	467.89
-16	3.2	4.67	67.73	18	64.4	13.75	199.43	54	129.2	33.74	489.36
-15	5.0	4.84	70.20	19	66.2	14.13	204.94	56	132.8	35.28	511.69
-14	6.8	5.02	72.81	20	68.0	14.53	210.74	58	136.4	36.86	534.61
-13	8.6	5.20	75.42	21	69.8	14.93	216.54	60	140.0	38.49	558.25
-12	10.4	5.38	78.03	22	71.6	15.35	222.63	62	143.6	40.17	582.62
-11	12.2	5.58	80.93	23	73.4	15.77	228.72	65	149.0	42.78	620.47
-10	14.0	5.77	83.69	24	75.2	16.20	234.96	67	152.6	44.57	646.43

### 4.4.2 Resistance / temperature lists of temperature sensors

4.4.2.1 Voltage list of 15 kΩ temperature sensors (including ODU and IDU temperature sensors)

Temperature		Resistance	Voltage	Temperature		Resistance	Voltage
°C	°F	kΩ	V	°C	°F	kΩ	V
-20	-4	144	0.311	71	159.8	2.523	2.825
-19	-2.2	138.1	0.323	72	161.6	2.439	2.838
-18	-0.4	128.6	0.345	73	163.4	2.358	2.852
-17	1.4	121.6	0.362	74	165.2	2.28	2.865

Temperature		Resistance	Voltage	Temperature		Resistance	Voltage
-16	3.2	115	0.381	75	167	2.205	2.877
-15	5	108.7	0.4	76	168.8	2.133	2.889
-14	6.8	102.9	0.42	77	170.6	2.064	2.901
-13	8.6	97.4	0.44	78	172.4	1.997	2.912
-12	10.4	92.22	0.462	79	174.2	1.933	2.923
-11	12.2	87.35	0.484	80	176	1.871	2.934
-10	14	82.75	0.506	81	177.8	1.811	2.945
-9	15.8	78.43	0.53	82	179.6	1.754	2.955
-8	17.6	74.35	0.554	83	181.4	1.699	2.964
-7	19.4	70.5	0.579	84	183.2	1.645	2.974
-6	21.2	66.88	0.605	85	185	1.594	2.983
-5	23	63.46	0.631	86	186.8	1.544	2.992
-4	24.8	60.23	0.658	87	188.6	1.497	3.001
-3	26.6	57.18	0.686	88	190.4	1.451	3.009
-2	28.4	54.31	0.714	89	192.2	1.408	3.017
-1	30.2	51.59	0.743	90	194	1.363	3.025
0	32	49.02	0.773	91	195.8	1.322	3.033
1	33.8	46.8	0.801	92	197.6	1.282	3.04
2	35.6	44.31	0.835	93	199.4	1.244	3.047
3	37.4	42.14	0.866	94	201.2	1.207	3.054
4	39.2	40.09	0.899	95	203	1.171	3.061
5	41	38.15	0.931	96	204.8	1.136	3.068
6	42.8	36.32	0.965	97	206.6	1.103	3.074
7	44.6	34.58	0.998	98	208.4	1.071	3.08
8	46.4	32.94	1.033	99	210.2	1.039	3.086
9	48.2	31.38	1.067	100	212	1.009	3.092
10	50	29.9	1.102	101	213.8	0.98	3.098
11	51.8	28.51	1.138	102	215.6	0.952	3.103
12	53.6	27.18	1.174	103	217.4	0.925	3.108
13	55.4	25.92	1.21	104	219.2	0.898	3.114
14	57.2	24.73	1.246	105	221	0.873	3.119
15	59	23.6	1.282	106	222.8	0.848	3.123
16	60.8	22.53	1.319	107	224.6	0.825	3.128
17	62.6	21.51	1.356	108	226.4	0.802	3.133
18	64.4	20.54	1.393	109	228.2	0.779	3.137
19	66.2	19.63	1.429	110	230	0.758	3.141
20	68	18.75	1.467	111	231.8	0.737	3.145
21	69.8	17.93	1.503	112	233.6	0.717	3.15
22	71.6	17.14	1.54	113	235.4	0.697	3.153
23	73.4	16.39	1.577	114	237.2	0.678	3.157
24	75.2	15.68	1.613	115	239	0.66	3.161
25	77	15	1.65	116	240.8	0.642	3.165
26	78.8	14.36	1.686	117	242.6	0.625	3.168
27	80.6	13.74	1.722	118	244.4	0.608	3.171
28	82.4	13.16	1.758	119	246.2	0.592	3.175
29	84.2	12.6	1.793	120	248	0.577	3.178
30	86	12.07	1.829	121	249.8	0.561	3.181
31	87.8	11.57	1.863	122	251.6	0.547	3.184
32	89.6	11.09	1.897	123	253.4	0.532	3.187

Temperature		Resistance	Voltage	Temperature		Resistance	Voltage
33	91.4	10.63	1.931	124	255.2	0.519	3.19
34	93.2	10.2	1.964	125	257	0.505	3.192
35	95	9.779	1.998	126	258.8	0.492	3.195
36	96.8	9.382	2.03	127	260.6	0.48	3.198
37	98.6	9.003	2.062	128	262.4	0.467	3.2
38	100.4	8.642	2.094	129	264.2	0.456	3.203
39	102.2	5.997	2.125	130	266	0.444	3.205
41	105.8	7.653	2.185	131	267.8	0.433	3.207
42	107.6	7.352	2.215	132	269.6	0.422	3.21
43	109.4	7.065	2.243	133	271.4	0.412	3.212
44	111.2	6.791	2.272	134	273.2	0.401	3.214
45	113	6.529	2.299	135	275	0.391	3.216
46	114.8	6.278	2.326	136	276.8	0.382	3.218
47	116.6	6.038	2.353	137	278.6	0.372	3.22
48	118.4	5.809	2.379	138	280.4	0.363	3.222
49	120.2	5.589	2.404	139	282.2	0.355	3.224
50	122	5.379	2.429	140	284	0.346	3.226
51	123.8	5.179	2.453	141	285.8	0.338	3.227
52	125.6	4.986	2.477	142	287.6	0.33	3.229
53	127.4	4.802	2.5	143	289.4	0.322	3.231
54	129.2	4.625	2.522	144	291.2	0.314	3.232
55	131	4.456	2.544	145	293	0.307	3.234
56	132.8	4.294	2.566	146	294.8	0.299	3.235
57	134.6	4.139	2.586	147	296.6	0.292	3.237
58	136.4	3.99	2.607	148	298.4	0.286	3.238
59	138.2	3.848	2.626	149	300.2	0.279	3.24
60	140	3.711	2.646	150	302	0.273	3.241
61	141.8	3.579	2.664	151	303.8	0.266	3.242
62	143.6	3.454	2.682	152	305.6	0.261	3.244
63	145.4	3.333	2.7	153	307.4	0.254	3.245
64	147.2	3.217	2.717	154	309.2	0.248	3.246
65	149	3.105	2.734	155	311	0.243	3.247
66	150.8	2.998	2.75	156	312.8	0.237	3.249
67	152.6	2.898	2.766	157	314.6	0.232	3.25
68	154.4	2.797	2.781	158	316.4	0.227	3.251
69	156.2	2.702	2.796	159	318.2	0.222	3.252
70	158	2.611	2.811	160	320	0.217	3.253

4.4.2.2 Voltage list of 20 kΩ pipeline temperature sensors (including temperature sensors for defroster, sub-cooler, gas/liquid separator, and IDU suction and discharge pipes)

Temperature		Resistance	Voltage	Temperature		Resistance	Voltage
°C	°F	kΩ	V	°C	°F	kΩ	V
-30	-22	361.8	0.173	66	150.8	3.998	2.75
-29	-20.2	339.8	0.183	67	152.6	3.861	2.766
-28	-18.4	319.2	0.195	68	154.4	3.729	2.781
-27	-16.6	300	0.206	69	156.2	3.603	2.796
-26	-14.8	282.2	0.218	70	158	3.481	2.811
-25	-13	265.5	0.231	71	159.8	3.364	2.825
-24	-11.2	249.9	0.245	72	161.6	3.252	2.838

Temperature		Resistance	Voltage	Temperature		Resistance	Voltage
-23	-9.4	235.3	0.259	73	163.4	3.144	2.852
-22	-7.6	221.6	0.273	74	165.2	3.04	2.865
-21	-5.8	208.9	0.288	75	167	2.94	2.877
-20	-4	196.9	0.304	76	168.8	2.844	2.889
-19	-2.2	181.4	0.328	77	170.6	2.752	2.901
-18	-0.4	171.4	0.345	78	172.4	2.663	2.912
-17	1.4	162.1	0.362	79	174.2	2.577	2.923
-16	3.2	153.3	0.381	80	176	2.495	2.934
-15	5	145	0.4	81	177.8	2.415	2.944
-14	6.8	137.2	0.42	82	179.6	2.339	2.954
-13	8.6	129.9	0.44	83	181.4	2.265	2.964
-12	10.4	123	0.462	84	183.2	2.194	2.974
-11	12.2	116.5	0.484	85	185	2.125	2.983
-10	14	110.3	0.507	86	186.8	2.059	2.992
-9	15.8	104.6	0.53	87	188.6	1.996	3.001
-8	17.6	99.13	0.554	88	190.4	1.934	3.009
-7	19.4	94	0.579	89	192.2	1.875	3.017
-6	21.2	89.17	0.605	90	194	1.818	3.025
-5	23	84.61	0.631	91	195.8	1.763	3.033
-4	24.8	80.31	0.658	92	197.6	1.71	3.04
-3	26.6	76.24	0.686	93	199.4	1.658	3.047
-2	28.4	72.41	0.714	94	201.2	1.609	3.054
-1	30.2	68.79	0.743	95	203	1.561	3.061
0	32	65.37	0.773	96	204.8	1.515	3.068
1	33.8	62.13	0.804	97	206.6	1.47	3.074
2	35.6	59.08	0.835	98	208.4	1.427	3.08
3	37.4	56.19	0.866	99	210.2	1.386	3.086
4	39.2	53.46	0.898	100	212	1.346	3.092
5	41	50.87	0.931	101	213.8	1.307	3.098
6	42.8	48.42	0.965	102	215.6	1.269	3.103
7	44.6	46.11	0.998	103	217.4	1.233	3.108
8	46.4	43.92	1.033	104	219.2	1.198	3.114
9	48.2	41.84	1.067	105	221	1.164	3.119
10	50	39.87	1.102	106	222.8	1.131	3.123
11	51.8	38.01	1.138	107	224.6	1.099	3.128
12	53.6	36.24	1.174	108	226.4	1.069	3.133
13	55.4	34.57	1.209	109	228.2	1.039	3.137
14	57.2	32.98	1.246	110	230	1.01	3.141
15	59	31.47	1.282	111	231.8	0.9825	3.145
16	60.8	30.04	1.319	112	233.6	0.9556	3.15
17	62.6	28.68	1.356	113	235.4	0.9295	3.153
18	64.4	27.39	1.393	114	237.2	0.9043	3.157
19	66.2	26.17	1.429	115	239	0.8799	3.161
20	68	25.01	1.466	116	240.8	0.8562	3.165
21	69.8	23.9	1.503	117	242.6	0.8333	3.168
22	71.6	22.85	1.54	118	244.4	0.8111	3.171
23	73.4	21.85	1.577	119	246.2	0.7895	3.175
24	75.2	20.9	1.614	120	248	0.7687	3.178
25	77	20	1.65	121	249.8	0.7485	3.181

Temperature		Resistance	Voltage	Temperature		Resistance	Voltage
26	78.8	19.14	1.686	122	251.6	0.7289	3.184
27	80.6	18.32	1.722	123	253.4	0.7099	3.187
28	82.4	17.55	1.758	124	255.2	0.6915	3.19
29	84.2	16.8	1.793	125	257	0.6736	3.192
30	86	16.1	1.828	126	258.8	0.6563	3.195
31	87.8	15.43	1.863	127	260.6	0.6395	3.198
32	89.6	14.79	1.897	128	262.4	0.6232	3.2
33	91.4	14.18	1.931	129	264.2	0.6074	3.203
34	93.2	13.59	1.965	130	266	0.5921	3.205
35	95	13.04	1.998	131	267.8	0.5772	3.207
36	96.8	12.51	2.03	132	269.6	0.5627	3.21
37	98.6	12	2.063	133	271.4	0.5487	3.212
38	100.4	11.52	2.094	134	273.2	0.5351	3.214
39	102.2	11.06	2.125	135	275	0.5219	3.216
40	104	10.62	2.155	136	276.8	0.509	3.218
41	105.8	10.2	2.185	137	278.6	0.4966	3.22
42	107.6	9.803	2.215	138	280.4	0.4845	3.222
43	109.4	9.42	2.243	139	282.2	0.4727	3.224
44	111.2	9.054	2.272	140	284	0.4613	3.226
45	113	8.705	2.299	141	285.8	0.4502	3.227
46	114.8	8.37	2.326	142	287.6	0.4394	3.229
47	116.6	8.051	2.353	143	289.4	0.4289	3.231
48	118.4	7.745	2.379	144	291.2	0.4187	3.232
49	120.2	7.453	2.404	145	293	0.4088	3.234
50	122	7.173	2.429	146	294.8	0.3992	3.235
51	123.8	6.905	2.453	147	296.6	0.3899	3.237
52	125.6	6.648	2.477	148	298.4	0.3808	3.238
53	127.4	6.403	2.5	149	300.2	0.3719	3.24
54	129.2	6.167	2.522	150	302	0.3633	3.241
55	131	5.942	2.544	151	303.8	0.3549	3.242
56	132.8	5.726	2.565	152	305.6	0.3468	3.244
57	134.6	5.519	2.586	153	307.4	0.3389	3.245
58	136.4	5.32	2.607	154	309.2	0.3312	3.246
59	138.2	5.13	2.626	155	311	0.3237	3.247
60	140	4.948	2.646	156	312.8	0.3164	3.249
61	141.8	4.773	2.664	157	314.6	0.3093	3.25
62	143.6	4.605	2.682	158	316.4	0.3024	3.251
63	145.4	4.443	2.7	159	318.2	0.2956	3.252
64	147.2	4.289	2.717	160	320	0.2891	3.253
65	149	4.14	2.734				

#### 4.2.2.3 Voltage list of 50 kΩ discharge temperature sensors (including top temperature sensor, and discharge air temperature sensor)

Temperature		Resistance	Voltage	Temperature		Resistance	Voltage
°C	°F	kΩ	V	°C	°F	kΩ	V
-30	-22	911.56	0.036	61	141.8	11.736	1.518
-29	-20.2	853.66	0.038	62	143.6	11.322	1.548
-28	-18.4	799.98	0.041	63	145.4	10.925	1.577
-27	-16.6	750.18	0.043	64	147.2	10.544	1.606
-26	-14.8	703.92	0.046	65	149	10.178	1.635
-25	-13	660.93	0.049	66	150.8	9.8269	1.664
-24	-11.2	620.94	0.052	67	152.6	9.4896	1.693
-23	-9.4	583.72	0.056	68	154.4	9.1655	1.722
-22	-7.6	549.04	0.059	69	156.2	8.9542	1.741
-21	-5.8	516.71	0.063	70	158	8.5551	1.778
-20	-4	486.55	0.066	71	159.8	5.9676	1.806
-19	-2.2	458.4	0.07	72	161.6	7.9913	1.834
-18	-0.4	432.1	0.075	73	163.4	7.7257	1.862
-17	1.4	407.51	0.079	74	165.2	7.4702	1.889
-16	3.2	384.51	0.084	75	167	7.2245	1.916
-15	5	362.99	0.088	76	168.8	6.9882	1.943
-14	6.8	342.83	0.094	77	170.6	6.7608	1.969
-13	8.6	323.94	0.099	78	172.4	6.542	1.995
-12	10.4	306.23	0.104	79	174.2	6.3315	2.021
-11	12.2	289.61	0.11	80	176	6.1288	2.046
-10	14	274.02	0.116	81	177.8	5.9336	2.071
-9	15.8	259.37	0.123	82	179.6	5.7457	2.096
-8	17.6	245.61	0.129	83	181.4	5.5647	2.12
-7	19.4	232.67	0.136	84	183.2	5.3903	2.144
-6	21.2	220.5	0.143	85	185	5.2223	2.168
-5	23	209.05	0.151	86	186.8	5.0605	2.191
-4	24.8	195.97	0.158	87	188.6	4.9044	2.214
-3	26.6	188.12	0.167	88	190.4	4.7541	2.237
-2	28.4	178.65	0.175	89	192.2	4.6091	2.259
-1	30.2	169.68	0.184	90	194	4.4693	2.281
0	32	161.02	0.193	91	195.8	4.3345	2.302
1	33.8	153	0.202	92	197.6	4.2044	2.323
2	35.6	145.42	0.212	93	199.4	4.0789	2.344
3	37.4	135.96	0.223	94	201.2	3.9579	2.364
4	39.2	131.5	0.233	95	203	3.841	2.384
5	41	126.17	0.242	96	204.8	3.7283	2.404
6	42.8	119.08	0.256	97	206.6	3.6194	2.423
7	44.6	113.37	0.267	98	208.4	3.5143	2.442
8	46.4	107.96	0.28	99	210.2	3.4128	2.46
9	48.2	102.85	0.292	100	212	3.3147	2.478
10	50	98.006	0.306	101	213.8	3.22	2.496
11	51.8	93.42	0.319	102	215.6	3.1285	2.514
12	53.6	89.075	0.333	103	217.4	3.0401	2.531
13	55.4	84.956	0.348	104	219.2	2.9547	2.547
14	57.2	81.052	0.362	105	221	2.8721	2.564

Temperature		Resistance	Voltage	Temperature		Resistance	Voltage
15	59	77.349	0.378	106	222.8	2.7922	2.58
16	60.8	73.896	0.393	107	224.6	2.715	2.595
17	62.6	70.503	0.41	108	226.4	2.6404	2.611
18	64.4	67.338	0.427	109	228.2	2.5682	2.626
19	66.2	64.333	0.444	110	230	2.4983	2.64
20	68	61.478	0.462	111	231.8	2.4308	2.655
21	69.8	58.766	0.48	112	233.6	2.3654	2.669
22	71.6	56.189	0.499	113	235.4	2.3021	2.682
23	73.4	53.738	0.518	114	237.2	2.2409	2.696
24	75.2	51.408	0.537	115	239	2.1816	2.709
25	77	49.191	0.558	116	240.8	2.1242	2.722
26	78.8	47.082	0.578	117	242.6	2.0686	2.734
27	80.6	45.074	0.599	118	244.4	2.0148	2.747
28	82.4	43.163	0.621	119	246.2	1.9626	2.759
29	84.2	41.313	0.643	120	248	1.9123	2.77
30	86	39.61	0.665	121	249.8	1.8652	2.781
31	87.8	37.958	0.688	122	251.6	1.8158	2.793
32	89.6	36.384	0.711	123	253.4	1.7698	2.804
33	91.4	34.883	0.735	124	255.2	1.7253	2.814
34	93.2	33.453	0.759	125	257	1.6821	2.825
35	95	32.088	0.784	126	258.8	1.6402	2.835
36	96.8	30.787	0.809	127	260.6	1.5996	2.845
37	98.6	29.544	0.835	128	262.4	1.5602	2.855
38	100.4	28.359	0.86	129	264.2	1.522	2.864
39	102.2	27.227	0.886	130	266	1.485	2.873
40	104	26.147	0.913	131	267.8	1.449	2.882
41	105.8	25.114	0.94	132	269.6	1.4141	2.891
42	107.6	24.128	0.967	133	271.4	1.3803	2.9
43	109.4	23.186	0.994	134	273.2	1.3474	2.908
44	111.2	22.286	1.022	135	275	1.3155	2.916
45	113	21.425	1.05	136	276.8	1.2846	2.924
46	114.8	20.601	1.078	137	278.6	1.2545	2.932
47	116.6	19.814	1.107	138	280.4	1.2233	2.94
48	118.4	19.061	1.136	139	282.2	1.1969	2.947
49	120.2	18.34	1.164	140	284	1.1694	2.955
50	122	17.651	1.193	141	285.8	1.1476	2.96
51	123.8	16.99	1.223	142	287.6	1.1166	2.969
52	125.6	16.358	1.252	143	289.4	1.0913	2.975
53	127.4	15.753	1.281	144	291.2	1.0667	2.982
54	129.2	15.173	1.311	145	293	1.0429	2.988
55	131	14.618	1.34	146	294.8	1.0197	2.995
56	132.8	14.085	1.37	147	296.6	0.9971	3.001
57	134.6	13.575	1.4	148	298.4	0.9752	3.007
58	136.4	13.086	1.429	149	300.2	0.9538	3.013
59	138.2	12.617	1.459	150	302	0.9331	3.018
60	140	12.368	1.475				

### 4.4.3 Voltage / pressure lists of pressure sensors

#### 4.4.3.1 High-pressure sensor (R410A)

Temperature		Absolute pressure		Voltage	Temperature		Absolute pressure		Voltage
°C	°F	kPa	psi	V	°C	°F	kPa	psi	V
-40	-40	176	25.5	0.102	16	60.8	1300	188.5	1.3
-39	-38.2	184	26.7	0.111	17	62.6	1337	193.9	1.34
-38	-36.4	193	28	0.12	18	64.4	1375	199.4	1.38
-37	-34.6	202	29.3	0.13	19	66.2	1413	204.9	1.421
-36	-32.8	211	30.6	0.139	20	68	1453	210.7	1.463
-35	-31	220	31.9	0.149	21	69.8	1493	216.5	1.506
-34	-29.2	230	33.4	0.16	22	71.6	1535	222.6	1.551
-33	-27.4	240	34.8	0.17	23	73.4	1577	228.7	1.596
-32	-25.6	250	36.3	0.181	24	75.2	1620	234.9	1.641
-31	-23.8	261	37.8	0.193	25	77	1664	241.3	1.688
-30	-22	273	39.6	0.206	26	78.8	1708	247.7	1.735
-29	-20.2	283	41	0.216	27	80.6	1754	254.3	1.784
-28	-18.4	295	42.8	0.229	28	82.4	1801	261.1	1.834
-27	-16.6	307	44.5	0.242	29	84.2	1848	268	1.884
-26	-14.8	319	46.3	0.255	30	86	1897	275.1	1.937
-25	-13	332	48.1	0.268	31	87.8	1946	282.2	1.989
-24	-11.2	345	50	0.282	32	89.6	1996	289.4	2.042
-23	-9.4	359	52.1	0.297	33	91.4	2048	297	2.098
-22	-7.6	373	54.1	0.312	34	93.2	2100	304.5	2.153
-21	-5.8	388	56.3	0.328	35	95	2153	312.2	2.21
-20	-4	403	58.4	0.344	36	96.8	2208	320.2	2.268
-19	-2.2	418	60.6	0.36	37	98.6	2263	328.1	2.327
-18	-0.4	434	62.9	0.377	38	100.4	2320	336.4	2.388
-17	1.4	450	65.3	0.394	39	102.2	2377	344.7	2.448
-16	3.2	467	67.7	0.412	40	104	2436	353.2	2.511
-15	5	484	70.2	0.43	41	105.8	2495	361.8	2.574
-14	6.8	502	72.8	0.45	42	107.6	2556	370.6	2.639
-13	8.6	520	75.4	0.469	43	109.4	2618	379.6	2.705
-12	10.4	538	78	0.488	44	111.2	2681	388.7	2.772
-11	12.2	558	80.9	0.509	45	113	2745	398	2.841
-10	14	577	83.7	0.53	46	114.8	2810	407.5	2.91
-9	15.8	597	86.6	0.551	47	116.6	2876	417	2.98
-8	17.6	618	89.6	0.573	48	118.4	2944	426.9	3.053
-7	19.4	639	92.7	0.596	49	120.2	3013	436.9	3.126
-6	21.2	661	95.8	0.619	50	122	3083	447	3.201
-5	23	684	99.2	0.644	51	123.8	3154	457.3	3.277
-4	24.8	707	102.5	0.668	52	125.6	3226	467.8	3.353
-3	26.6	730	105.9	0.693	53	127.4	3300	478.5	3.432
-2	28.4	754	109.3	0.718	54	129.2	3374	489.2	3.511
-1	30.2	779	113	0.745	55	131	3450	500.3	3.592
0	32	804	116.6	0.772	56	132.8	3528	511.6	3.675
1	33.8	830	120.4	0.799	57	134.6	3606	522.9	3.759
2	35.6	857	124.3	0.828	58	136.4	3686	534.5	3.844
3	37.4	884	128.2	0.857	59	138.2	3767	546.2	3.93
4	39.2	912	132.2	0.887	60	140	3849	558.1	4.018



Temperature		Absolute pressure		Voltage	Temperature		Absolute pressure		Voltage
5	41	940	136.3	0.917	61	141.8	3932	570.1	4.106
6	42.8	969	140.5	0.947	62	143.6	4017	582.5	4.197
7	44.6	999	144.9	0.979	63	145.4	4103	594.9	4.288
8	46.4	1030	149.4	1.012	64	147.2	4190	607.6	4.381
9	48.2	1061	153.8	1.046	65	149	4278	620.3	4.475
10	50	1093	158.5	1.08	66	150.8	4367	633.2	4.57
11	51.8	1125	163.1	1.114	67	152.6	4457	646.3	4.666
12	53.6	1159	168.1	1.15	68	154.4	4548	659.5	4.763
13	55.4	1193	173	1.186	69	156.2	4639	672.7	4.86
14	57.2	1228	178.1	1.224	70	158	4731	686	4.958
15	59	1263	183.1	1.261	71	159.8	4893	709.5	5.13

#### 4.4.3.2 Low-pressure sensor (R410A)

Temperature		Absolute pressure		Voltage	Temperature		Absolute pressure		Voltage
°C	°F	kPa	psi	V	°C	°F	kPa	psi	V
-70	-94	36	5.2	0.369	-14	6.8	502	72.8	1.301
-69	-92.2	38	5.5	0.373	-13	8.6	520	75.4	1.337
-68	-90.4	40	5.8	0.377	-12	10.4	538	78	1.373
-67	-88.6	43	6.2	0.383	-11	12.2	558	80.9	1.413
-66	-86.8	46	6.7	0.389	-10	14	577	83.7	1.451
-65	-85	48	7	0.393	-9	15.8	597	86.6	1.491
-64	-83.2	51	7.4	0.399	-8	17.6	618	89.6	1.533
-63	-81.4	54	7.8	0.405	-7	19.4	639	92.7	1.575
-62	-79.6	57	8.3	0.411	-6	21.2	661	95.8	1.619
-61	-77.8	61	8.8	0.419	-5	23	684	99.2	1.665
-60	-76	64	9.3	0.425	-4	24.8	707	102.5	1.711
-59	-74.2	68	9.9	0.433	-3	26.6	730	105.9	1.757
-58	-72.4	72	10.4	0.441	-2	28.4	754	109.3	1.805
-57	-70.6	76	11	0.449	-1	30.2	799	115.9	1.895
-56	-68.8	80	11.6	0.457	0	32	804	116.6	1.905
-55	-67	84	12.2	0.465	1	33.8	830	120.4	1.957
-54	-65.2	89	12.9	0.475	2	35.6	857	124.3	2.011
-53	-63.4	94	13.6	0.485	3	37.4	884	128.2	2.065
-52	-61.6	99	14.4	0.495	4	39.2	912	132.2	2.121
-51	-59.8	104	15.1	0.505	5	41	940	136.3	2.177
-50	-58	109	15.8	0.515	6	42.8	969	140.5	2.235
-49	-56.2	115	16.7	0.527	7	44.6	999	144.9	2.295
-48	-54.4	121	17.5	0.539	8	46.4	1030	149.4	2.357
-47	-52.6	127	18.4	0.551	9	48.2	1061	153.8	2.419
-46	-50.8	133	19.3	0.563	10	50	1096	158.9	2.489
-45	-49	140	20.3	0.577	11	51.8	1125	163.1	2.547
-44	-47.2	146	21.2	0.589	12	53.6	1159	168.1	2.615
-43	-45.4	154	22.3	0.605	13	55.4	1193	173	2.683
-42	-43.6	161	23.3	0.619	14	57.2	1228	178.1	2.753
-41	-41.8	168	24.4	0.633	15	59	1263	183.1	2.823
-40	-40	176	25.5	0.649	16	60.8	1300	188.5	2.897
-39	-38.2	184	26.7	0.665	17	62.6	1337	193.9	2.971
-38	-36.4	193	28	0.683	18	64.4	1375	199.4	3.047
-37	-34.6	202	29.3	0.701	19	66.2	1413	204.9	3.123

Temperature		Absolute pressure		Voltage	Temperature		Absolute pressure		Voltage
-36	-32.8	211	30.6	0.719	20	68	1453	210.7	3.203
-35	-31	220	31.9	0.737	21	69.8	1493	216.5	3.283
-34	-29.2	230	33.4	0.757	22	71.6	1535	222.6	3.367
-33	-27.4	240	34.8	0.777	23	73.4	1577	228.7	3.451
-32	-25.6	250	36.3	0.797	24	75.2	1620	234.9	3.537
-31	-23.8	261	37.8	0.819	25	77	1664	241.3	3.625
-30	-22	272	39.4	0.841	26	78.8	1708	247.7	3.713
-29	-20.2	283	41	0.863	27	80.6	1754	254.3	3.805
-28	-18.4	295	42.8	0.887	28	82.4	1801	261.1	3.899
-27	-16.6	307	44.5	0.911	29	84.2	1848	268	3.993
-26	-14.8	319	46.3	0.935	30	86	1897	275.1	4.091
-25	-13	332	48.1	0.961	31	87.8	1946	282.2	4.189
-24	-11.2	345	50	0.987	32	89.6	1996	289.4	4.289
-23	-9.4	359	52.1	1.015	33	91.4	2048	297	4.393
-22	-7.6	373	54.1	1.043	34	93.2	2100	304.5	4.497
-21	-5.8	388	56.3	1.073	35	95	2153	312.2	4.603
-20	-4	403	58.4	1.103	36	96.8	2208	320.2	4.713
-19	-2.2	418	60.6	1.133	37	98.6	2263	328.1	4.823
-18	-0.4	434	62.9	1.165	38	100.4	2320	336.4	4.937
-17	1.4	450	65.3	1.197	39	102.2	2377	344.7	5.051
-16	3.2	467	67.7	1.231	40	104	2439	353.7	5.175
-15	5	484	70.2	1.265					

### 4.5 EXPLODED VIEWS AND SPARE PART LIST

Modle GMV-72WM/B-F (U)

Product Code CN851W1380, CN851W1381

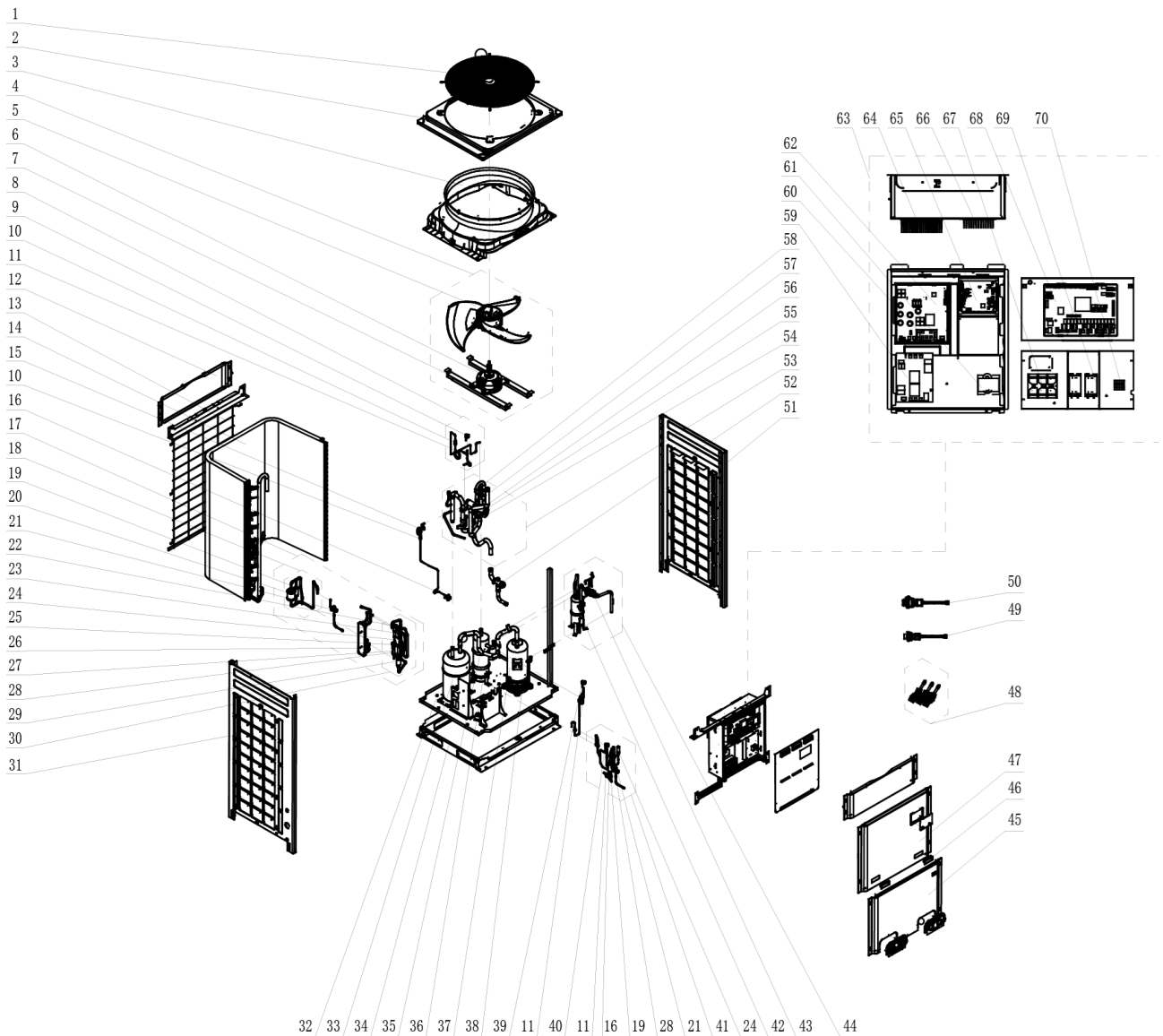

No.	Name of part	Part code	Quantity
1	Rear Grill	01574105	1
2	Top Cover	01264100030P	1
3	Diversion Circle	10474100	1
4	Fan motor Sub-Assy	15404100057	1
5	Axial Flow Fan Sub-Assy	10338702	1
6	Fan Motor	15704119	1
7	Motor Support Sub-Assy	01804771P	2
8	Gas By-pass Sub-Assy	04224100129	1
9	Magnet Coil	4304410018902	1
10	Filter A	07415200002	1
11	Electromagnetic Valve	43000054	1
12	Top Cover	01264231P	2
13	Rear Grill	01576013	1
14	Condenser Assy	0112431001	1
15	Low Pressure Survey Valve Sub-Assy	07334100026	1
16	Cut-off Valve 1/4	07130239	1
17	Throttle Assy	05374100006	1

No.	Name of part	Part code	Quantity
18	Dry Filter Sub-Assy	07314100001	1
19	Gas Tube Filter	072190511	1
20	Dry Filter	07218769	1
21	Cut-off Valve 3/8	07334100011	1
22	Electronic Expansion Valve Coil	4304413206	1
23	Electronic Expansion Valve	07334390	1
24	Discharge Valve	07334100002	1
25	Electronic Expansion Valve Coil	4304413204	1
26	Plate-type Heat Exchanger	00904100005	1
27	Electronic Expansion Valve	07334412	1
28	One way Valve	04324001	1
29	Bidirectional Filter	07210044	1
30	Electronic Expansion Valve Sub-Assy	07334100030	1
31	Left Side Plate	01314712P	1
32	Chassis Sub-assy	01194100065P	1
33	Gas-liquid Separator	07424188	1
34	Base Frame Assy	01284711	1
35	Oil Separator	0742418601	1
36	Electrical Heater(Compressor)	7651873209	1
37	Compressor and Fittings	00204100011	1
38	Electric Heater(Compressor)	7651540713	1
39	Magnet Coil	4304410018901	1
40	Magnet Coil	4304410018904	1
41	Oil Equalizing Pipe Sub-Assy	04224100148	1
42	Oil Separator	07424100023	1
43	Pressure Switch	4602000911	1
44	Discharge Tube Sub-assy	04534100113	1
45	Front Panel	01544627P	1
46	Handle	26904100016	2
47	Front Panel	01544620P	1
48	Temperature Sensor Sub-Assy	39008000006G	1
49	Pressure Sensor	32218000009	1
50	Pressure Sensor	32218000008	1
51	Right Side Plate	01314713P	1
52	Cut-off Valve 7/8	07334100014	1
53	4-Way Valve Sub-Assy	04044100063	1
54	Filter	07218603	1
55	Magnet Coil	43044100189	1
56	4-way Valve	43000339	1
57	One way Valve	07335210	1
58	Nozzle for Adding Freon	06120012	2
59	Filter Board	30228000032	1
60	Rectifier	46018000014	1
61	Reactor	43138000049	1
62	Main Board	30228000031	1
63	Electric Box Assy	01394100431	1
64	Radiator	4901800000201	1
65	Main Board	30223000047	1
66	Radiator	49018000001	1
67	Terminal Board	42010247	1
68	Main Board	30223000005	1
69	AC Contactor	44010265	2
70	Terminal Board	42018000026	1

## Modle GMV-72WM/B-U (U)

No.	Name of part	Part code	Quantity
1	Rear Grill	'01574105	1
2	Top Cover	'01264100030P	1
3	Diversion Circle	'10474100	1
4	Fan motor Sub-Assy	'15404605	1
5	Axial Flow Fan Sub-Assy	'10338702	1
6	Fan Motor	'15704124	1
7	Motor Support Sub-Assy	'01804771P	2
8	Gas By-pass Sub-Assy	'030082000007	1
9	Magnet Coil	4304000474	1
10	Filter	07415200002	1
11	Electromagnetic Valve	43000072	1
12	Top Cover	'01264231P	2
13	Rear Grill	'01576013	1
14	Condenser Assy	'01124310	1
15	Low Pressure Survey Valve Sub-Assy	'07334100026	1
16	Cut-off Valve 1/4	'07130239	1
17	Throttle Assy	'05374100006	1
18	Dry Filter Sub-Assy	'07314100001	1
19	Gas Tube Filter	'072190511	1
20	Dry Filter	'07218769	1
21	Cut-off Valve 3/8	'07334100011	1
22	Electronic Expansion Valve Coil	4304413206	1
23	Electronic Expansion Valve	'07334390	1
24	Discharge Valve	'07334100002	1
25	Electronic Expansion Valve Coil	4304413249	1
26	Plate-type Heat Exchanger	'00904100005	1
27	Electronic Expansion Valve	07334412	1
28	One way Valve	'04324001	1
29	Bidirectional Filter	'07210044	1
30	Electronic Expansion Valve Sub-Assy	'07334100030	1
31	Left Side Plate	'01314712P	1
32	Chassis Sub-assy	'01194100104P	1
33	Gas-liquid Separator	'07424188	1
34	Base Frame Assy	01284711	1
35	Oil Separator	0742418601	1
36	Electrical Heater(Compressor)	'7651873209	1
37	Compressor and Fittings	'00204100016	1
38	Electric Heater(Compressor)	7651540713	1
39	Magnet Coil	4304000477	1
40	Electromagnetic Valve	'43044100144	1
41	Magnet Coil	4304000473	1
42	Oil Equalizing Pipe Sub-Assy	04224100148	1
43	Oil Separator	07424100023	1
44	Pressure Switch	4602000911	1
45	Discharge Tube Sub-assy	'04534100095	1
46	transformer	'43118000023	2
47	Front Panel	01544627P	1
48	Handle	26904100016	1
49	Front Panel	01544620P	1
50	Temperature Sensor Sub-Assy	39008000006G	1
51	Pressure Sensor	32218000009	1
52	Pressure Sensor	32218000008	1
53	Right Side Plate	01314713P	1

No.	Name of part	Part code	Quantity
54	4-Way Valve Sub-Assy	'04044100063	1
55	8Cut-off Valve 7/8	'07334100012	1
56	Filter	'07218603	1
57	Magnet Coil	'4300040095	1
58	4-way Valve	'43000339	2
59	One way Valve	'07335210	1
60	Nozzle for Adding Freon	'06120012	1
61	Filter Board	30228000015	1
62	Rectifier	46010604	1
63	Reactor	'4313017401	1
64	Main Board	30228000010	1
65	Electric Box Assy	'01394100506	1
66	Radiator	49018000002	1
67	Main Board	30229010	1
68	Radiator	49018000001	1
69	Terminal Board	'42018000558	2
70	Terminal Board	'42011106	1
71	Main Board	30223000005	1
72	Terminal Board	42018000026	1

Modle GMV-96WM/B-F (U)

Product Code CN851W1390, CN851W1391

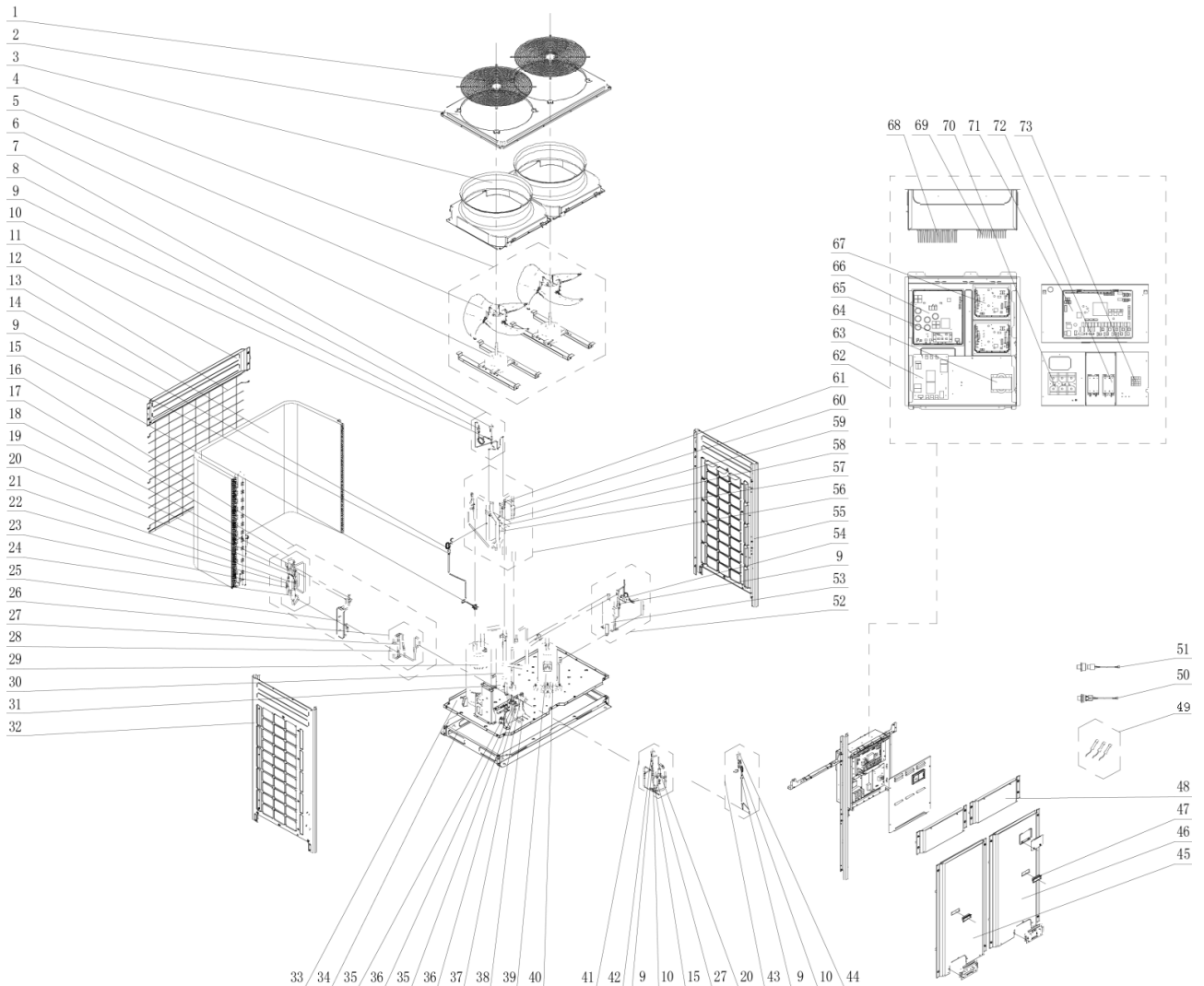

No.	Name of part	Part code	Quantity
1	Rear Grill	01574100002	1
2	Top Cover	01264100006P	1
3	Diversion Circle	10474100002	1
4	Motor for Axial Fan Assy	15404100056	1
5	Axial Flow Fan	10434100002	1
6	Fan Motor	15704119	1
7	Gas By-pass sub- assy	04634100012	1
8	Magnet Coil	4304410018906	1
9	Filter	07415200002	1
10	Electromagnetic Valve	43000054	1
11	Rear Top Cover	01264100005P	1
12	Rear Grill	01574100001	1
13	Condenser Assy	0112410009001	1
14	Low Pressure Survey Valve Sub-assy	07334100010	1
15	Cut off Valve	07130239	1
16	Throttle Assy	05374100017	1
17	Electric Expansion Valve Sub-Assy	43044100162	1
18	Electric expand valve fitting	4304413203	1
19	Electronic Expansion Valve	07334390	1
20	Discharge Charge Valve	07334100002	1
21	One way Valve	04324001	1
22	Electric expand valve fitting	4304413204	1
23	Electronic Expansion Valve	07334412	1
24	Bidirection Strainer	07210044	1
25	Dry Filter Sub-Assy	00904100012	1
26	Dry Filter Sub-Assy	07414100016	1
27	Gas Tube Filter	072190511	1
28	Dry Filter	07218769	1
29	Gas-liquid Separator	07424138	1
30	Oil Separator	0742418601	1
31	Electric Heater(Compressor)	7651873209	1
32	Right Side Plate	01314713P	1
33	Chassis Sub-assy	01194100020P	1
34	Base Frame Assy	01284100002	1
35	Valve	07304100007	1
36	Cut off Valve	07334100011	1
37	Gas Hose Sub-Assy	04574100043	1
38	Cut off Valve	07334100014	1
39	Compressor	00204100011	1
40	Electric Heater(Compressor)	7651540713	1
41	Oil Equalizing Pipe Sub-Assy	04224100054	1
42	Magnet Coil	4304410018905	1
43	Oil Equalizing Pipe Sub-Assy	04224100440	1
44	Magnet Coil	4304410018901	1
45	Left Front Panel	01544100003P	1
46	Right Front Panel	01544100005P	1
47	Handle	26904100016	1
48	Front Top Cover	01264100004P	1
49	Sensor Sub-assy	39004100008G	1
50	Pressure Sensor	32218000009	1
51	Pressure Sensor	32218000008	1
52	Discharge Tube Sub-assy	04534100114	1
53	Oil Separator	07424100023	1
54	Pressure Protect Switch	4602000910	1
55	Left Side Plate	01314712P	1

No.	Name of part	Part code	Quantity
56	4-Way Valve Sub-Assy	04044100055	1
57	Filter	07218603	1
58	Magnet Coil	4304410018903	1
59	4-way Valve	43000339	1
60	One way Valve	07335210	1
61	Nozzle for Adding Freon	06120012	1
62	Electric Box Assy	01394100447	1
63	Filter Board	30228000032	1
64	Reactor	43138000049	1
65	Rectifier	46018000014	1
66	Main Board	30228000031	1
67	Main Board	30223000047	1
68	Radiator	490180000201	1
69	Radiator	49018000001	1
70	Terminal Board	42018000558	1
71	Main Board	30223000005	1
72	AC Contactor	44010265	1
73	Terminal Board	42018000026	1

## Modle GMV-96WM/B-U (U)

No.	Name of part	Part code	Quantity
1	Rear Grill	'01574100002	
2	Top Cover	'01264100006P	
3	Diversion Circle	'10474100002	
4	Motor for Axial Fan Assy	'15404100018	
5	Axial Flow Fan	'10434100002	
6	Fan Motor	'15704124	
7	Gas By-pass sub- assy	'43000072	
8	Magnet Coil	'4304000420	
9	Filter	'07415200002	
10	Electromagnetic Valve	'43000054	
11	Rear Top Cover	'01264100005P	
12	Rear Grill	'01574100001	
13	Condenser Assy	'0112410009001	
14	Low Pressure Survey Valve Sub-assy	'07334100010	
15	Cut off Valve	'07130239	
16	Throttle Assy	'05374100017	
17	Electric Expansion Valve Sub-Assy	'43044100162	
18	Electric expand valve fitting	'4304413203	
19	Electronic Expansion Valve	'07334390	
20	Discharge Charge Valve	'07334100002	
21	One way Valve	'04324001	
22	Electric expand valve fitting	'4304413204	
23	Electronic Expansion Valve	'07334412	
24	Bidirection Strainer	'07210044	
25	Dry Filter Sub-Assy	'00904100005	
26	Dry Filter Sub-Assy	'07414100016	
27	Gas Tube Filter	'072190511	
28	Dry Filter	'07218769	
29	Gas-liquid Separator	'07424138	
30	Oil Separator	'0742418601	
31	Electric Heater(Compressor)	'7651873209	
32	Right Side Plate	'01314713P	
33	Chassis Sub-assy	'01194100106P	



No.	Name of part	Part code	Quantity
34	Base Frame Assy	'01284100122	
35	Cut off Valve	'07334100011	
36	Liquid Valve Sub-Assy	'07304100002	
37	Valve	'07304100007	
38	Cut off Valve	'07334100014	
39	Gas Hose Sub-Assy	'04574100027	
40	Compressor	'00204100016	
41	Electric Heater(Compressor)	'7651540713	
42	Oil Equalizing Pipe Sub-Assy	'04224100054	
43	Magnet Coil	'4304000440	
44	Oil Equalizing Pipe Sub-Assy	'030181000008	
45	Electromagnetic Valve	'43044100144	
46	Magnet Coil	'4304000423	
47	transformer	'43118000023	
48	Left Front Panel	'01544100003P	
49	Right Front Panel	'01544100005P	
50	Handle	'26904100016	
51	Front Top Cover	'01264100004P	
52	Sensor Sub-assy	'39004100008G	
53	Pressure Sensor	'32218000009	
54	Pressure Sensor	'32218000008	
55	Discharge Tube Sub-assy	'04534100094	
56	Oil Separator	'07424100023	
57	Pressure Protect Switch	'4602000910	
58	Left Side Plate	'01314712P	
59	4-Way Valve Sub-Assy	'04044100060	
60	Filter	'07218603	
61	Magnet Coil	'4300040030	
62	4-way Valve	'43000339	
63	One way Valve	'07335210	
64	Nozzle for Adding Freon	'06120012	
65	Electric Box Assy	100002003641	
66	Filter Board	'30228000015	
67	Main Board	'300027000545	
68	Reactor	'4313017401	
69	Rectifier	46010604	
70	Main Board	30228000010	
71	Main Board	30229009	
72	Radiator	49018000002	
73	Radiator	49018000001	
74	Terminal Board	'42018000026	
75	Main Board	30223000005	
76	Terminal Board	'42018000558	
77	Terminal Board	'42011106	

Modle GMV-120WM/B-F (U)

Product Code CN851W1420, CN851W1421

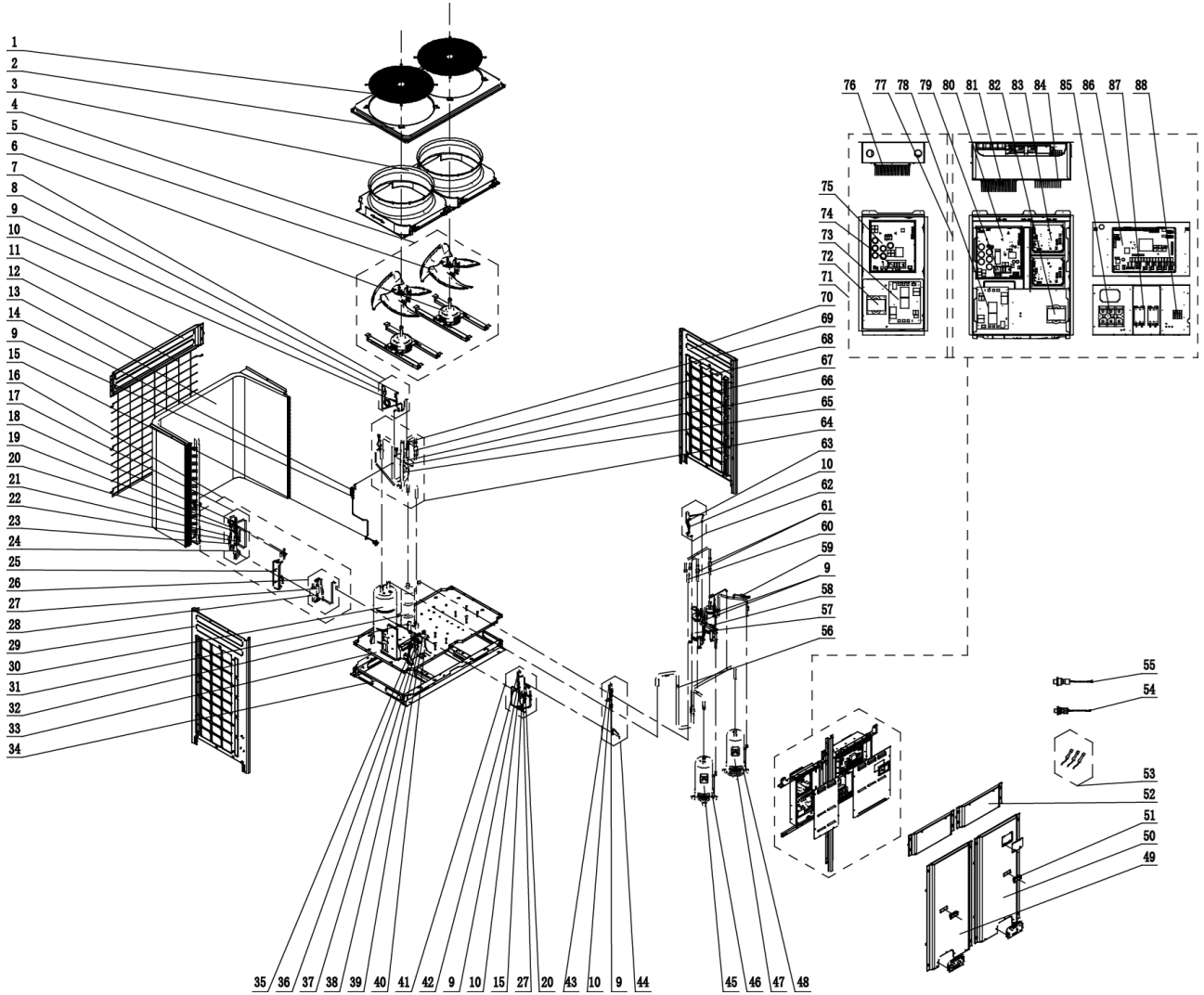

No.	Name of part	Part code	Quantity
1	Rear Grill	01574100002	2
2	Top Cover	01264100006P	1
3	Diversion Circle	10474100002	2
4	Motor for Axial Fan Assy	15404100056	2
5	Axial Flow Fan Blade	10434100002	1
6	Fan Motor	15704119	1
7	Gas By-pass Sub- Assy	04634100012	1
8	Magnet Coil	4304410018906	1
9	Filter	07415200002	1
10	Electromagnetic Valve	43000054	2
11	Cover Plate	01264100005P	1
12	Rear Grill	01574100001	1
13	Condenser Assy	0112410009001	1
14	Low Pressure Survey Valve Sub-Assy	07334100010	1
15	Cut-off Valve 1/4	07130239	1
16	Throttle Assy	05374100003	1
17	Electronic Expansion Valve Fittingss	43044100012	1
18	Electronic Expansion Valve Fittings	4304413204	1
19	Electronic Expansion Valve	07331139	1
20	Discharge Valve	07334100002	1
21	Electronic Expansion Valve Fittings	4304413203	1

No.	Name of part	Part code	Quantity
22	Check Valve	04324001	1
23	Electronic Expansion Valve	07334412	1
24	Bidirectional Filter	07210044	1
25	Plate-type Heat Exchanger Sub-Assy	00904100007	1
26	Dry Filter Sub-Assy	07314100002	1
27	Gas Tube Filter	072190511	1
28	Dry Filter	07218769	1
29	Left Side Plate	01314712P	1
30	Gas-liquid Separator	07424138	1
31	Oil Separator	0742418601	1
32	Electrical Heater(Compressor)	7651873209	1
33	Chassis Sub-Assy	01194100001P	1
34	Base Frame Assy	01284100002	1
35	Cut-off Valve 1/2	07334100013	1
36	Liquid Valve Sub-Assy	07304100009	1
37	Cut-off Valve 3/8	07334100011	1
38	Valve	07304100007	1
39	Cut-off Valve 1-1/8	07334100014	1
40	Gas Valve Sub-Assy	07304100008	1
41	Oil Equalizing Pipe Sub-Assy 1	04224100054	1
42	Magnet Coil (electromagnetic valve)	4304410018905	1
43	Magnet Coil (electromagnetic valve)	4304410018901	1
44	Oil Equalizing Pipe Sub-Assy 2	04224100059	1
45	Compressor and Fittings	00204128	1
46	Electric Heater(Compressor)	7651540714	1
47	Compressor	00204100011	1
48	Electric Heater(Compressor)	7651540713	1
49	Front Panel (Left)	01544100003P	1
50	Front Panel (Right)	01544100005P	1
51	Handle	26904100016	2
52	Cover Plate	01264100004P	2
53	Sensor Sub-Assy	39008000028G	1
54	Pressure Sensor	32218000009	1
55	Pressure Sensor	32218000008	1
56	Suction Pipe Sub-Assy	04574100114	1
57	Oil Separator	07424100023	1
58	Pressure Switch	4602000911	1
59	Pressure Switch	4602000912	1
60	Exhaust Trunk Sub-Assy	'04534100012	1
61	Check Valve	07333700032	2
62	Gas By-pass Sub- Assy	04514100036	1
63	Magnet Coil (electromagnetic valve)	4304410018907	1
64	4-Way Valve Assy	04044100060	1
65	Filter	07218603	1
66	Magnet Coil (electromagnetic valve)	4304410018903	1
67	4-way Valve	43000339	1
68	Check Valve	07335210	1
69	Nozzle for Adding Freon	06120012	2
70	Right Side Plate	01314713P	1
71	Electric Box Assy	01394100365	1
72	Reactor	43130174	1
73	Filter Board	30228119	1
74	Rectifier	46010608	1
75	Main Board	30228608	1
76	Radiator	4901060501	1

No.	Name of part	Part code	Quantity
77	Electric Box Assy	01394100432	1
78	Filter Board	30228000032	1
79	Rectifier	46018000014	1
80	Main Board	30228000031	1
81	Radiator	4901800000201	1
82	Reactor	43138000049	1
83	Main Board	30223000047	1
84	Radiator	49018000001	1
85	Terminal Board	42018000558	1
86	Main Board	30223000005	1
87	AC Contactor	44010265	1
88	Terminal Board	42018000026	1

## Modle GMV-120WM/B-U (U)

No.	Name of part	Part code	Quantity
1	Rear Grill	'01574100002	
2	Coping	'01264100006P	
3	Diversion Circle	'10474100002	
4	Axial Flow Fan	'10434100002	
5	Brushless DC Motor	15704124	
6	Motor for Axial Fan Assy	'15404100018	
7	Upper Cover Plate (back)	'01264100005P	
8	Pressure Protect Switch	'4602000911	
9	Rear Grill	'01574100001	
10	Oil Separator	07424100023	
11	Condenser Assy	'0112410009001	
12	4-Way Valve Assy	'04044100060	
13	Nozzle for Adding Freon	'06120012	
14	Strainer	07415200002	
15	Magnet Coil	4304000425	
16	Electromagnetic Valve	43000072	
17	Gas By-pass sub- assy	'030082000006	
18	One way Valve	07335210	
19	4-way Valve	'43000339	
20	Magnet Coil	4300040030	
21	Filter	'07218603	
22	Gas-liquid Separator	'07424138	
23	Pressure Protect Switch	4602000912	
24	Throttle Assy	'05374100003	
25	Dry Filter Sub-Assy	'07314100002	
26	Gas Tube Filter	'072190511	
27	Plate-type Heat Exchanger Sub-Assy	'030166000055	
28	Dry Filter	'07218769	
29	Electric expand valve fitting	4304413203	
30	Electronic Expansion Valve	'07331139	
31	Discharge Charge Valve	'07334100002	
32	Electric Expand Valve Fitting	'4304413249	
33	One way Valve	04324001	
34	Electronic Expansion Valve	'07334412	
35	Bidirection Strainer	'07210044	
36	Electric Expansion Valve Sub-Assy	'43044100012	
37	Right Side Plate	'01314713P	
38	Magnet Coil (electromagnetic valve)	'4304000475	
39	Oil Balancing Tube Sub-assy 1	'04224100054	

No.	Name of part	Part code	Quantity
40	Electromagnetic Valve	43044100144	
41	Inhalation Tube Sub-assy	'04574100114	
42	Cut off Valve	'07130239	
43	Low Pressure Survey Valve Sub-assy	'07334100010	
44	Chassis Sub-assy	'01194100106P	
45	Base Frame Sub-Assy	'01284100122	
46	Oil Separator	0742418601	
47	Electrical Heater(Compressor)	'7651873209	
48	One Way Valve	07333700032	
49	Cut off Valve	'07334100013	
50	Liquid Valve Sub-Assy	'07304100009	
51	Valve	'07304100007	
52	Cut off Valve	'07334100011	
53	Gas Valve Sub-Assy	'07304100008	
54	Cut off Valve	'07334100014	
55	Exhaust Trunk Sub-assy	'04534100012	
56	Magnet Coil (electromagnetic valve)	4304000477	
57	Oil balancing pipe sub-assy 2	'030181000008	
58	Gas bypass sub-assy 1	'04514100036	
59	Electromagnetic Valve	'43000054	
60	Magnet Coil (electromagnetic valve)	4304000476	
61	Compressor and Fittings	'00204116	
62	Electric Heater(Compressor)	'7651540714	
63	Transformer	'43118000023	
64	Compressor and Fittings	'00204100016	
65	Electric Heater(Compressor)	7651540713	
66	Left Side Plate	'01314712P	
67	Handle	'26904100016	
68	Front Panel (left)	'01544100003P	
69	Top Cover (front)	'01264100004P	
70	Front Panel (right)	'01544100005P	
71	Pressure Sensor	'32218000009	
72	Pressure sensor	'32218000008	
73	Sensor Sub-assy	'39008000028G	
74	Reactor	'43138004	
75	Filter Board	'30228122	
76	Rectifier	'46010058	
77	Main Board	'30228609	
78	Radiator	'49018000002	
79	Electric Box Assy	'01394100356	
80	Electric Box Assy	100002003640	
81	Filter Board	'30228000015	
82	Main Board	'30228000010	
83	Rectifier	'46010604	
84	Main Board	'300027000545	
85	Main Board	'30229009	
86	Radiator	49018000001	
87	Reactor	'4313017401	
88	Terminal Board	'42018000558	
89	Main Board	'30223000005	
90	Terminal Board	'42011106	
91	Terminal Board	'42018000026	

Modle GMV-144WM/B1-F (U)

Product Code CN851W2000

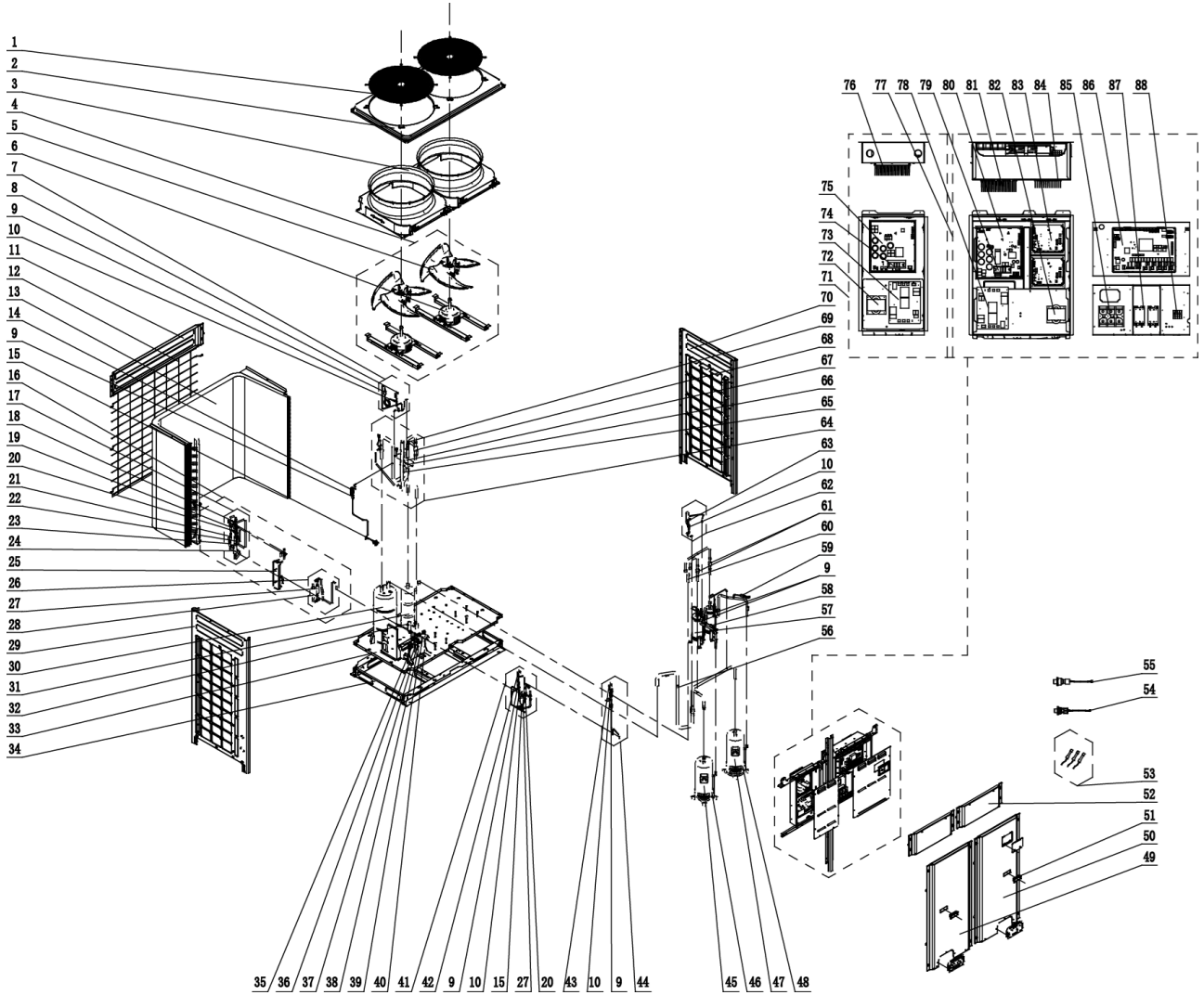

No.	Name of part	Part code	Quantity
1	Rear Grill	01574100002	2
2	Top Cover	01264100006P	1
3	Diversion Circle	10474100002	2
4	Motor for Axial Fan Assy	15404100056	2
5	Axial Flow Fan Blade	10434100002	1
6	Fan Motor	15704119	1
7	Gas By-pass Sub- Assy	04634100012	1
8	Magnet Coil	4304410018906	1
9	Filter	07415200002	1
10	Electromagnetic Valve	43000054	2
11	Cover Plate	01264100005P	1
12	Rear Grill	01574100001	1
13	Condenser Assy	0112410009001	1
14	Low Pressure Survey Valve Sub-Assy	07334100010	1
15	Cut-off Valve 1/4	07130239	1
16	Throttle Assy	05374100003	1
17	Electronic Expansion Valve Fittingss	43044100012	1
18	Electronic Expansion Valve Fittings	4304413204	1
19	Electronic Expansion Valve	43044100190	1
20	Discharge Valve	07334100002	1
21	Electronic Expansion Valve Fittings	4304413203	1

No.	Name of part	Part code	Quantity
22	Check Valve	04324001	1
23	Electronic Expansion Valve	43044100172	1
24	Bidirectional Filter	07210044	1
25	Plate-type Heat Exchanger Sub-Assy	00904100007	1
26	Dry Filter Sub-Assy	07314100002	1
27	Gas Tube Filter	072190511	1
28	Dry Filter	07218769	1
29	Left Side Plate	01314712P	1
30	Gas-liquid Separator	07424138	1
31	Oil Separator	0742418601	1
32	Electrical Heater(Compressor)	7651873209	1
33	Chassis Sub-Assy	01194100001P	1
34	Base Frame Assy	01284100002	1
35	Cut-off Valve 1/2	07334100013	1
36	Liquid Valve Sub-Assy	07304100009	1
37	Cut-off Valve 3/8	07334100011	1
38	Valve	07304100007	1
39	Cut-off Valve 1-1/8	07334100014	1
40	Gas Valve Sub-Assy	07304100008	1
41	Oil Equalizing Pipe Sub-Assy 1	04224100054	1
42	Magnet Coil (electromagnetic valve)	4304410018905	1
43	Magnet Coil (electromagnetic valve)	4304410018901	1
44	Oil Equalizing Pipe Sub-Assy 2	04224100059	1
45	` 00204100011	00204100011	1
46	Electric Heater(Compressor)	7651540714	1
47	Compressor	00204100011	1
48	Electric Heater(Compressor)	7651540713	1
49	Front Panel (Left)	01544100003P	1
50	Front Panel (Right)	01544100005P	1
51	Handle	26904100016	2
52	Cover Plate	01264100004P	2
53	Sensor Sub-Assy	39008000028G	1
54	Pressure Sensor	32218000009	1
55	Pressure Sensor	32218000008	1
56	Suction Pipe Sub-Assy	04574100114	1
57	Oil Separator	07424100023	1
58	Pressure Switch	4602000911	1
59	Pressure Switch	4602000912	1
60	Exhaust Trunk Sub-Assy	'04534100012	1
61	Check Valve	07333700032	2
62	Gas By-pass Sub- Assy	04514100036	1
63	Magnet Coil (electromagnetic valve)	4304410018907	1
64	4-Way Valve Assy	04044100060	1
65	Filter	07218603	1
66	Magnet Coil (electromagnetic valve)	4304410018903	1
67	4-way Valve	43000339	1
68	Check Valve	07335210	1
69	Nozzle for Adding Freon	06120012	2
70	Right Side Plate	01314713P	1
71	Electric Box Assy	01394100365	1
72	Reactor	43130174	1
73	Filter Board	30228119	1
74	Rectifier	46010608	1
75	Main Board	30228608	1
76	Radiator	4901060501	1

No.	Name of part	Part code	Quantity
77	Electric Box Assy	01394100432	1
78	Filter Board	30228000032	1
79	Rectifier	46018000014	1
80	Main Board	30228000031	1
81	Radiator	490180000201	1
82	Reactor	43138000049	1
83	Main Board	30223000047	1
84	Radiator	49018000001	1
85	Terminal Board	42018000558	1
86	Main Board	30223000005	1
87	AC Contactor	44010265	1
88	Terminal Board	42018000026	1

Mode GMV-168WM/B1-F (U)

Product Code CN851W2710

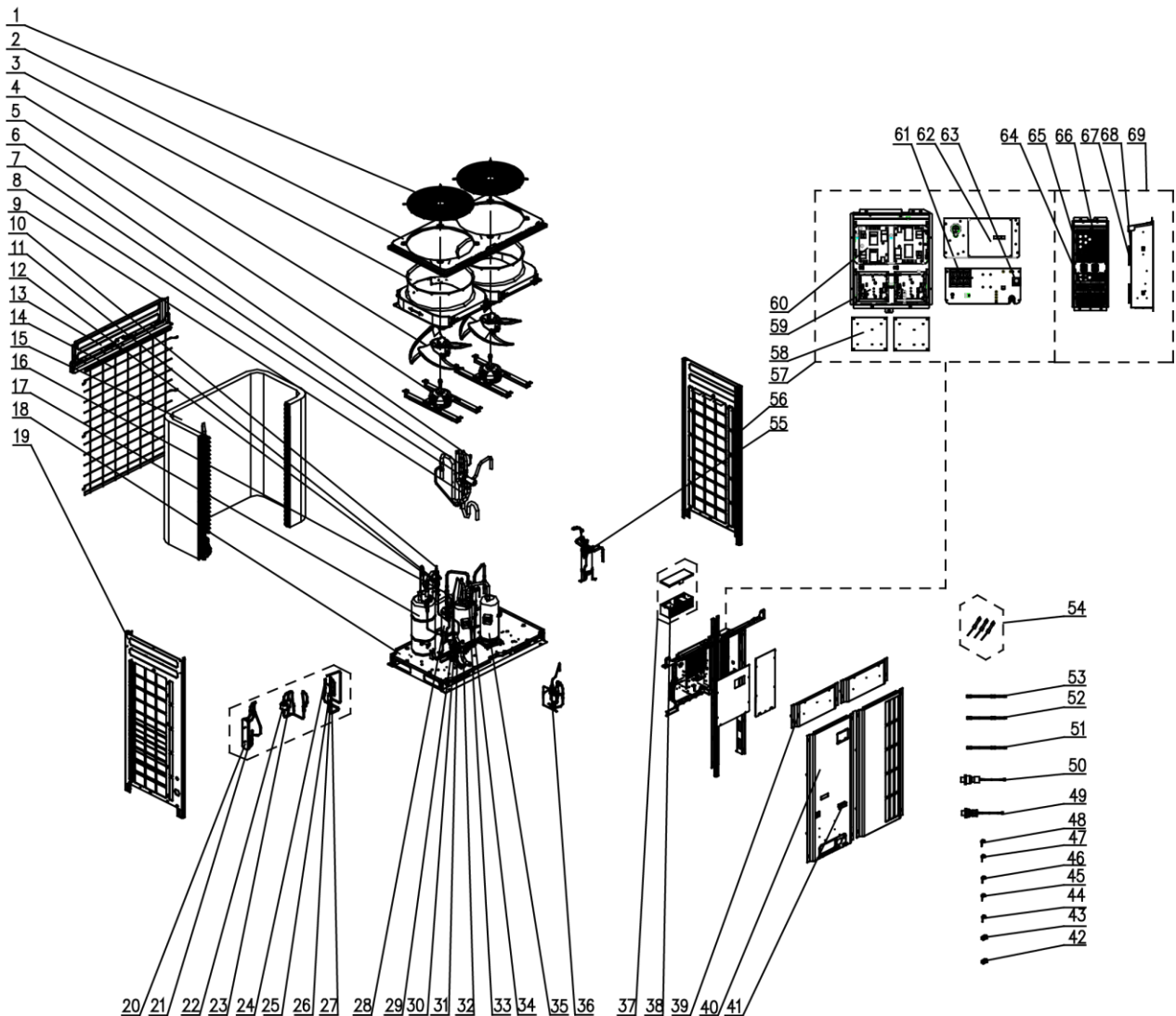

No.	Name of part	Part code	Quantity
1	Rear Grill	01574100002	2
2	Coping	01264100006P	1
3	Diversion Circle	10474100002	2
4	Axial Flow Fan	10434100002	2
5	Fan Motor	15704119	2
6	Nozzle for Adding Freon	06120012	2



No.	Name of part	Part code	Quantity
7	One way Valve	07335210	1
8	4-way Valve	43000412	1
9	Filter	07218603	1
10	Electromagnetic Valve	43000054	4
11	Electromagnetic Valve	43000072	
12	Strainer	07415200002	6
13	Upper Cover Plate (back)	01264100005P	1
14	Rear Grill	016001500381	1
15	Condenser Assy	01100250016201	1
16	One Way Valve	07333700032	2
17	Gas-liquid Separator	07424138	1
18	Chassis Sub-assy	01194100070P	1
19	Left Side Plate	012055500022P	1
20	Plate-type Heat Exchanger	00904100004	1
21	Electronic Expansion Valve	43044100172	1
22	Dry Filter	07218769	1
23	Gas Tube Filter	072190511	2
24	Electronic Expansion Valve	43044100190	1
25	Strainer	07210037	1
26	One way Valve	04324001	2
27	Discharge Charge Valve	07334100002	2
28	Oil Separator	07424100023	2
29	Cut off Valve	07130239	2
30	Cut off Valve	07334100053	1
31	Cut off Valve	07334100011	1
32	Cut off Valve	07334100014	1
33	Pressure Protect Switch	4602000911	1
34	Oil Separator	0742418601	1
35	Compressor and Fittings	00204100011	2
36	Electromagnetic Valve	43044100144	
37	Reactor Sub-assy	017036000020	1
38	Reactor	4313800004902	2
39	Top Cover (front)	01264100004P	2
40	Left Front Panel	012062500040P	1
41	Handle	26904100016	1
42	Electric expand valve fitting	4304413203	1
43	Electric Expand Valve Fitting	4304413204	1
44	Magnet Coil	4304000456	1
45	Magnet Coil	4304000455	1
46	Magnet Coi	4304000453	1
47	Magnet Coil	4300040032	1
48	Magnet Coil	4304000454	1
49	Pressure Sensor	32218000009	1
50	Pressure sensor	32218000008	1
51	Electric Heater(Compressor)	7651540713	1
52	Electric Heater(Compressor)	7651540714	1
53	Electrical Heater(Compressor)	7651873209	1
54	Sensor Sub-assy	39008000102G	1
55	Pressure Protect Switch	4602000912	1
56	Right Side Plate	012056500021P	1
57	Electric Box Assy	100002002649	1
58	Radiator	49018000001	2
59	Main Board	30223000041	2
60	Filter Board	30228000032	2
61	Terminal Board	42018000558	1

No.	Name of part	Part code	Quantity
62	Main Board	30223000041	1
63	Terminal Board	42018000026	1
64	Terminal Board	42018000577	2
65	AC Contactor	44010265	
66	Main Board	300027000130	2
67	Radiator	49018000088	2
68	Radiator	4901800008001	2
69	Electric Box Assy	100002002650	1



GREE ELECTRIC APPLIANCES, INC. OF ZHUHAI 519070

Add: West Jinji Rd, Qianshan Zhuhai, Guangdong, China

Tel: (+86-756)8522218

Fax: (+86-756)8669426

E-mail: [gree@gree.com.cn](mailto:gree@gree.com.cn) [www.gree.com](http://www.gree.com)

JF00302443